

Impact Sockets

1/4" Dr. Impact Sockets

6 pt. Metric Impact Sockets

ITEM NO.	Size mm	Length mm
212503	3	25
212504	4	25
2125045	4.5	25
212505	5	25
2125055	5.5	25
212506	6	25
212507	7	25
212508	8	25
212509	9	25
212510	10	25
212511	11	25
212512	12	25
212513	13	25
212514	14	25

6 pt. Metric Deep Impact Sockets

ITEM NO.	Size mm	Length mm
215204	4	50
2152045	4.5	50
215205	5	50
2152055	5.5	50
215206	6	50
215207	7	50
215208	8	50
215209	9	50
215210	10	50
215211	11	50
215212	12	50
215213	13	50
215214	14	50

6 pt. SAE Impact Sockets

ITEM NO.	Size Inch	Length mm
292504	1/8	25
292506	3/16	25
292507	7/32	25
292508	1/4	25
292509	9/32	25
292510	5/16	25
292511	11/32	25
292512	3/8	25
292514	7/16	25
292516	1/2	25
292518	9/16	25

6 pt. SAE Deep Impact Sockets

ITEM NO.	Size Inch	Length mm
295206	3/16	50
295207	7/32	50
295208	1/4	50
295209	9/32	50
295210	5/16	50
295211	11/32	50
295212	3/8	50
295214	7/16	50
295216	1/2	50
295218	9/16	50

1/4" Dr. Accessories

A Impact Adapter

ITEM NO.	Female Drive	Male Drive	Length mm
290030	1/4"	3/8"	25

B Impact Universal Joint

ITEM NO.	Outside Diameter	Length mm
700106	14mm	35

C Impact Bit Holders

ITEM NO.	Hex Shank	Length mm
263508	1/4"	35
263510	5/16"	35

D Impact Bit Holder

ITEM NO.	Hex Shank	Length mm
262808	1/4"	25

E Impact Extension Bars

ITEM NO.	Retention Device	Length mm (Inch)
210002	Ball	50 (2")
210003	Ball	75 (3")
210004	Ball	100 (4")
210006	Ball	150 (6")

1/4" Dr. Impact Socket Sets

TF-214M 14pcs Metric Impact Socket Set

14 1/4" Dr. Socket (212503 ~ 212514)
3 - 4 - 4.5 - 5 - 5.5 - 6 - 7 - 8 - 9 - 10 - 11 - 12 - 13 - 14mm

310g 60 Sets / 19.5 Kgs / 1.58 CUFT

TD-211M 11pcs Metric Deep Impact Socket Set

11 1/4" Dr. Deep Socket (215204 ~ 215213)
4 - 5 - 5.5 - 6 - 7 - 8 - 9 - 10 - 11 - 12 - 13mm

400g 20 Sets / 9 Kgs / 0.71 CUFT

TF-211S 11pcs SAE Impact Socket Set

11 1/4" Dr. Socket (292504 ~ 292518)
1/8 - 3/16 - 7/32 - 1/4 - 9/32 - 5/16 - 11/32 - 3/8 - 7/16 - 1/2 - 9/16"

260g 60 Sets / 18 Kgs / 1.58 CUFT

TD-210S 10pcs SAE Deep Impact Socket Set

10 1/4" Dr. Deep Socket (295206 ~ 295218)
3/16 - 7/32 - 1/4 - 9/32 - 5/16 - 11/32 - 3/8 - 7/16 - 1/2 - 9/16"

360g 20 Sets / 8 Kgs / 0.71 CUFT

TF-255MS 55pcs Metric & SAE Deep Impact Socket Set

14 1/4" Dr. Socket (212503 ~ 212514)
3 - 4 - 4.5 - 5 - 5.5 - 6 - 7 - 8 - 9 - 10 - 11 - 12 - 13 - 14mm

13 1/4" Dr. Deep Socket (215204 ~ 215214)
4 - 4.5 - 5 - 5.5 - 6 - 7 - 8 - 9 - 10 - 11 - 12 - 13 - 14mm

11 1/4" Dr. Socket (292504 ~ 292518)
1/8 - 3/16 - 7/32 - 1/4 - 9/32 - 5/16 - 11/32 - 3/8 - 7/16 - 1/2 - 9/16"

10 1/4" Dr. Deep Socket (295206 ~ 295218)
3/16 - 7/32 - 1/4 - 9/32 - 5/16 - 11/32 - 3/8 - 7/16 - 1/2 - 9/16"

1 1/4" Dr. Adapter 1/4" F x 3/8" M (290030)

1 1/4" Dr. Universal Joint (700106)

1 1/4" Dr. Bit Holder (263508)

4 1/4" Dr. Extension (210002 ~ 210006)
50 - 75 - 100 - 150mmL

1760g 12 Sets / 22 Kgs / 1.16 CUFT

IE-2349 9pcs Impact Extension Bar Set

3 1/4" Dr. Ext. (210002 ~ 210006)
50 - 100 - 150mmL

3 3/8" Dr. Ext. (380005 ~ 380036)
45 - 75 - 150mmL

3 1/2" Dr. Ext. (480002 ~ 480320)
50 - 125 - 250mmL

1400g 10 Sets / 15 Kgs / 0.93 CUFT

3/8" Dr. Impact Sockets



6 pt.
Metric Impact Sockets



6 pt.
Metric Deep Impact Sockets

ITEM NO.	Size mm	Length mm	ITEM NO.	Size mm	Length mm
343206	6	28	346306	6	63
343207	7	28	346307	7	63
343208	8	28	346308	8	63
343209	9	28	346309	9	63
343210	10	28	346310	10	63
343211	11	30	346311	11	63
343212	12	30	346312	12	63
343213	13	30	346313	13	63
343214	14	30	346314	14	63
343215	15	30	346315	15	63
343216	16	30	346316	16	63
343217	17	32	346317	17	63
343218	18	32	346318	18	63
343219	19	32	346319	19	63
343220	20	32	346320	20	63
343221	21	32	346321	21	63
343222	22	32	346322	22	63



6 pt.
SAE Impact Sockets



6 pt.
SAE Deep Impact Sockets

ITEM NO.	Size Inch	Length mm	ITEM NO.	Size Inch	Length mm
363208	1/4	28	366308	1/4	63
363210	5/16	28	366310	5/16	63
363211	11/32	28	366311	11/32	63
363212	3/8	28	366312	3/8	63
363214	7/16	30	366314	7/16	63
363216	1/2	30	366316	1/2	63
363218	9/16	30	366318	9/16	63
363219	19/32	30	366319	19/32	63
363220	5/8	30	366320	5/8	63
363222	11/16	32	366322	11/16	63
363224	3/4	32	366324	3/4	63
363225	25/32	32	366325	25/32	63
363226	13/16	32	366326	13/16	63
363228	7/8	32	366328	7/8	63

3/8" Dr. Accessories



A Impact Adapters

ITEM NO.	Female Drive	Male Drive	Retention Device	Length mm
340020	3/8"	1/4"	Ball	30
340040	3/8"	1/2"	Pin	35
340040B	3/8"	1/2"	Ball	35



B Impact Universal Joint

ITEM NO.	Outside Diameter	Length mm
700107	26mm	65



D Impact Extension Bars

ITEM NO.	Retention Device	Length mm (Inch)
340075	Pin	75 (3")
340075B	Ball	75 (3")
340125	Pin	125 (5")
340125B	Ball	125 (5")
340200	Pin	200 (8")
340200B	Ball	200 (8")





C Impact Bit Holders



ITEM NO.	Hex Shank	Length mm
363908	1/4"	39
364608	1/4"	46
363910	5/16"	39
364610	5/16"	46

3/8" Dr. Impact Socket Sets

CM-316M 16pcs Metric Impact Socket Set

16  3/8" Dr. Socket (343207 ~ 343222)
7 - 8 - 9 - 10 - 11 - 12 - 13 - 14 - 15 - 16 - 17 - 18 - 19 - 20 - 21 - 22mm

 **6 pt.**

 1170g  20 Sets / 24.5 Kgs / 0.88 CUFT

3/8" Dr. Impact Socket Sets

deep CM-316MD 16pcs Metric Deep Impact Socket Set

16  3/8" Dr. Socket (346307 ~ 346322)
7 - 8 - 9 - 10 - 11 - 12 - 13 - 14 - 15 - 16 - 17 - 18 - 19 - 20 - 21 - 22mm

 **6 pt.**

 2400g  10 Sets / 25 Kgs / 0.88 CUFT

deep CM-332M 32pcs Metric Deep Impact Socket Set

16  3/8" Dr. Socket (343207 ~ 343222)
7 - 8 - 9 - 10 - 11 - 12 - 13 - 14 - 15 - 16 - 17 - 18 - 19 - 20 - 21 - 22mm

16  3/8" Dr. Deep Socket (346307 ~ 346322)
7 - 8 - 9 - 10 - 11 - 12 - 13 - 14 - 15 - 16 - 17 - 18 - 19 - 20 - 21 - 22mm

 **6 pt.**

 1/3 Tray  3450g  5 Sets / 18 Kgs / 0.93 CUFT

CM-313S 13pcs SAE Impact Socket Set

13  3/8" Dr. Socket (363210 ~ 363228)
5/16 - 11/32 - 3/8 - 7/16 - 1/2 - 9/16 - 19/32 - 5/8 - 11/16 - 3/4 - 25/32 - 13/16 - 7/8"

 **6 pt.**

 1000g  15 Sets / 16 Kgs / 0.73 CUFT

deep CM-313SD 13pcs SAE Deep Impact Socket Set

13  3/8" Dr. Deep Socket (366310 ~ 366328)
5/16 - 11/32 - 3/8 - 7/16 - 1/2 - 9/16 - 19/32 - 5/8 - 11/16 - 3/4 - 25/32 - 13/16 - 7/8"

 **6 pt.**

 2100g  12 Sets / 26 Kgs / 0.73 CUFT

deep CM-326S 26pcs SAE Deep Impact Socket Set

13  3/8" Dr. Socket (363210 ~ 363228)
5/16 - 11/32 - 3/8 - 7/16 - 1/2 - 9/16 - 19/32 - 5/8 - 11/16 - 3/4 - 25/32 - 13/16 - 7/8"

13  3/8" Dr. Deep Socket (366310 ~ 366328)
5/16 - 11/32 - 3/8 - 7/16 - 1/2 - 9/16 - 19/32 - 5/8 - 11/16 - 3/4 - 25/32 - 13/16 - 7/8"

 **6 pt.**

 2700g  5 Sets / 14.5 Kgs / 0.63 CUFT

3/8" Dr. Swivel Impact Socket Sets

TG-312M 12pcs Metric Swivel Impact Socket Set

12  3/8" Dr. Swivel Socket (380008M ~ 380019M)
8 - 9 - 10 - 11 - 12 - 13 - 14 - 15 - 16 - 17 - 18 - 19mm

 **6 pt.**

 1270g  12 Sets / 16.5 Kgs / 0.73 CUFT

deep TG-312MD 12pcs Metric Deep Swivel Impact Socket Set

12  3/8" Dr. Deep Swivel Socket (380008MD ~ 380019MD)
8 - 9 - 10 - 11 - 12 - 13 - 14 - 15 - 16 - 17 - 18 - 19mm

 **6 pt.**

 2690g  8 Sets / 22.5 Kgs / 0.73 CUFT

TG-308S 8pcs SAE Swivel Impact Socket Set

8  3/8" Dr. Swivel Socket (380021 ~ 380028)
5/16 - 3/8 - 7/16 - 1/2 - 9/16 - 5/8 - 11/16 - 3/4"

 **6 pt.**

 780g  12 Sets / 10.5 Kgs / 0.7 CUFT

deep TG-308SD 8pcs SAE Deep Swivel Impact Socket Set

8  3/8" Dr. Deep Swivel Socket (380021D ~ 380028D)
5/16 - 3/8 - 7/16 - 1/2 - 9/16 - 5/8 - 11/16 - 3/4"

 **6 pt.**

 1830g  12 Sets / 23 Kgs / 0.95 CUFT

Impact Sockets

1/2" Dr. Impact Sockets

6 pt. Metric Impact Sockets



ITEM NO.	Size mm	Length mm
444008	8	38
444009	9	38
444010	10	38
444011	11	38
444012	12	38
444013	13	38
444014	14	38
444015	15	38
444016	16	38
444017	17	38
444018	18	38
444019	19	40
444020	20	40
444021	21	40
444022	22	42
444023	23	42
444024	24	44
444025	25	44
444026	26	44
444027	27	46
444028	28	46
444029	29	46
444030	30	46
444031	31	46
444032	32	46
444033	33	46
444034	34	46
444035	35	48
444036	36	48
444037	37	48
444038	38	48
444039	39	50
444040	40	55
444041	41	55

6 pt. Metric Deep Impact Sockets



ITEM NO.	Size mm	Length mm
447808	8	78
447809	9	78
447810	10	78
447811	11	78
447812	12	78
447813	13	78
447814	14	78
447815	15	78
447816	16	78
447817	17	78
447818	18	78
447819	19	78
447820	20	78
447821	21	78
447822	22	78
447823	23	78
447824	24	78
447825	25	78
447826	26	78
447827	27	78
447828	28	78
447829	29	78
447830	30	78
447831	31	78
447832	32	78
447833	33	78
447834	34	78
447835	35	78
447836	36	78
447837	37	78
447838	38	78
447839	39	78
447840	40	78
447841	41	78

1/2" Dr. Impact Sockets

6 pt. Metric Thin Wall Impact Sockets



ITEM NO.	Size mm	Length mm
443808	8	38
443809	9	38
443810	10	38
443811	11	38
443812	12	38
443813	13	38
443814	14	38
443815	15	38
443816	16	38
443817	17	38
443818	18	38
443819	19	40
443820	20	40
443821	21	40
443822	22	42
443823	23	42
443824	24	44
443825	25	44
443826	26	44
443827	27	46
443828	28	46
443829	29	46
443830	30	46
443831	31	46
443832	32	46
443833	33	46
443834	34	46
443835	35	48
443836	36	48
443837	37	48
443838	38	48
443839	39	50
443840	40	55
443841	41	55

12 pt. Metric Thin Wall Impact Sockets



ITEM NO.	Size mm	Length mm
453808	8	38
453809	9	38
453810	10	38
453811	11	38
453812	12	38
453813	13	38
453814	14	38
453815	15	38
453816	16	38
453817	17	38
453818	18	38
453819	19	40
453820	20	40
453821	21	40
453822	22	42
453823	23	42
453824	24	44
453825	25	44
453826	26	44
453827	27	46
453828	28	46
453829	29	46
453830	30	46
453831	31	46
453832	32	46
453833	33	46
453834	34	46
453835	35	48
453836	36	48
453837	37	48
453838	38	48
453839	39	50
453840	40	55
453841	41	55

6 pt. SAE Impact Sockets



ITEM NO.	Size Inch	Length mm
464010	5/16	38
464012	3/8	38
464014	7/16	38
464016	1/2	38
464018	9/16	38
464019	19/32	38
464020	5/8	38
464022	11/16	38
464024	3/4	40
464025	25/32	40
464026	13/16	40
464028	7/8	42
464030	15/16	44
464032	1	44
464034	1-1/16	46
464036	1-1/8	46
464038	1-3/16	46
464040	1-1/4	46
464042	1-5/16	46
464044	1-3/8	48
464046	1-7/16	48
464048	1-1/2	48
464050	1-9/16	55
464052	1-5/8	55

6 pt. SAE Deep Impact Sockets



ITEM NO.	Size Inch	Length mm
467810	5/16	78
467812	3/8	78
467814	7/16	78
467816	1/2	78
467818	9/16	78
467819	19/32	78
467820	5/8	78
467822	11/16	78
467824	3/4	78
467825	25/32	78
467826	13/16	78
467828	7/8	78
467830	15/16	78
467832	1	78
467834	1-1/16	78
467836	1-1/8	78
467838	1-3/16	78
467840	1-1/4	78
467842	1-5/16	78
467844	1-3/8	78
467846	1-7/16	78
467848	1-1/2	78
467850	1-9/16	78
467852	1-5/8	78

6 pt. SAE Thin Wall Impact Sockets



ITEM NO.	Size Inch	Length mm
463810	5/16	38
463812	3/8	38
463814	7/16	38
463816	1/2	38
463818	9/16	38
463819	19/32	38
463820	5/8	38
463822	11/16	38
463824	3/4	40
463825	25/32	40
463826	13/16	40
463828	7/8	42
463830	15/16	44
463832	1	44
463834	1-1/16	46
463836	1-1/8	46
463838	1-3/16	46
463840	1-1/4	46
463842	1-5/16	46
463844	1-3/8	48
463846	1-7/16	48
463848	1-1/2	48
463850	1-9/16	55
463852	1-5/8	55

6 pt. Metric Semi-Deep Thin Wall Impact Sockets



ITEM NO.	Size mm	Length mm
445210	10	52
445211	11	52
445212	12	52
445213	13	52
445214	14	52
445215	15	52
445216	16	52
445217	17	52
445218	18	52
445219	19	52
445220	20	52
445221	21	52
445222	22	52
445223	23	52
445224	24	52

1/2" Dr. Impact Sockets



12 pt.
Metric
Deep Thin Wall
Impact Sockets

ITEM NO.	Size mm	Length mm
448508	8	85
448509	9	85
448510	10	85
448511	11	85
448512	12	85
448513	13	85
448514	14	85
448515	15	85
448516	16	85
448517	17	85
448518	18	85
448519	19	85
448520	20	85
448521	21	85
448522	22	85
448523	23	85
448524	24	85
448525	25	85
448526	26	85
448527	27	85
448528	28	85
448529	29	85
448530	30	85
448531	31	85
448532	32	85
448533	33	85
448534	34	85
448535	35	85
448536	36	85
448537	37	85
448538	38	85
448539	39	85
448540	40	85
448541	41	85

6 pt.
Extra-Deep
Impact Sockets

ITEM NO.	Size	Length mm
4412711	11mm	127
4412715	15mm	127

4612716	1/2"	127
4612720	5/8"	127
4612722	11/16"	127

6 pt.
SAE
Extra-Thin Wall
Flip Impact Sockets

ITEM NO.	Size Hex	Size Hex	Length mm
49762426	3/4"	13/16"	76

1/2" Dr. Accessories

A Impact Adapters

ITEM NO.	Female Drive	Male Drive	Retention Device	L mm
480033CM	1/2"	3/8"	Pin	38
480033MB	1/2"	3/8"	Ball	38
480066CM	1/2"	3/4"	Pin	41
480066MB	1/2"	3/4"	Ball	41

B Impact Universal Joint

ITEM NO.	Outside Diameter	Length mm
700108	28mm	70

C Impact Bit Holders

ITEM NO.	Hex Shank	Length mm
464808	1/4"	48
464108	1/4"	41
464810	5/16"	48
464110	5/16"	41

E Impact Extension Bars

ITEM NO.	Retention Device	Length mm (Inch)
480032CM	Pin	75 (3")
480032MB	Ball	75 (3")
480036CM	Pin	125 (5")
480036MB	Ball	125 (5")
480150CM	Pin	150 (6")
480150MB	Ball	150 (6")
480200CM	Pin	200 (8")
480200MB	Ball	200 (8")
480250CM	Pin	250 (10")
480250MB	Ball	250 (10")

D Impact Bit Holders

ITEM NO.	Hex Shank	Length mm
463608	1/4"	38
463610	5/16"	38

1/2" Dr. Impact Socket Sets

GS-409M 9pcs Metric Impact Socket Set

9 1/2" Dr. Socket (444011 ~ 444022)
11 - 12 - 13 - 14 - 16
17 - 19 - 21 - 22mm

6 pt.

1350g 20 Sets / 28 Kgs / 0.64 CUFT

GS-409M2 9pcs Metric Impact Socket Set

9 1/2" Dr. Socket (444011 ~ 444024)
10 - 11 - 12 - 13 - 14 -
17 - 19 - 22 - 24mm

6 pt.

1350g 20 Sets / 28 Kgs / 0.64 CUFT

GS-417 17pcs Metric Impact Socket Set

17 1/2" Dr. Socket (444008 ~ 444030)
8 - 9 - 10 - 11 - 12 - 13 -
14 - 15 - 16 - 17 - 18 - 19 -
21 - 22 - 24 - 27 - 30mm

6 pt.

2800g 6 Sets / 18 Kgs / 1.16 CUFT

IS-425M 25pcs Metric Impact Socket Set

25 1/2" Dr. Socket (444008 ~ 444036)
8 - 9 - 10 - 11 - 12 - 13 - 14 -
15 - 16 - 17 - 18 - 19 - 20 - 21 -
22 - 23 - 24 - 25 - 26 - 27 - 28 -
29 - 30 - 32 - 36mm

6 pt.

4000g 3 Sets / 13 Kgs / 0.82 CUFT

Deep CM-008 10pcs Metric Deep Impact Socket Set

10 1/2" Dr. Deep Socket (447811 ~ 447824)
11 - 12 - 13 - 14 - 16 - 17 -
19 - 21 - 22 - 24mm

6 pt.

2600g 10 Sets / 27 Kgs / 0.52 CUFT

Deep CD-415M 13pcs Metric Deep Impact Socket Set

13 1/2" Dr. Deep Socket (447810 ~ 447830)
10 - 11 - 12 - 13 - 14 - 16 - 17 -
19 - 21 - 22 - 24 - 27 - 30mm

6 pt.

4500g 4 Sets / 19 Kgs / 0.43 CUFT

Deep DI-425M 25pcs Metric Deep Impact Socket Set

25 1/2" Dr. Deep Socket (447808 ~ ~36)
8 - 9 - 10 - 11 - 12 - 13 - 14 -
15 - 16 - 17 - 18 - 19 - 20 - 21 -
22 - 23 - 24 - 25 - 26 - 27 - 28 -
29 - 30 - 32 - 36mm

6 pt.

7000g 3 Sets / 22 Kgs / 0.82 CUFT

Deep GS-440M 40pcs Master Metric Deep Impact Socket Set

19 1/2" Dr. Socket (444009 ~ 444030)
9 - 10 - 11 - 12 - 13 - 14 - 15 - 16 -
17 - 18 - 19 - 20 - 21 - 22 - 23 - 24 -
26 - 27 - 30mm

19 1/2" Dr. Deep Socket (447809 ~ 447830)
9 - 10 - 11 - 12 - 13 - 14 - 15 - 16 -
17 - 18 - 19 - 20 - 21 - 22 - 23 - 24 -
26 - 27 - 30mm

1 1/2" Dr. Universal Joint (700108)

1 1/2" Dr. Extension 125mmL (480036MB)



6 pt.



8000g 3 Sets / 25 Kgs / 1.16 CUFT

Impact Sockets



1/2" Dr. Impact Socket Sets



FS-409S 9pcs SAE Impact Socket Set

9  1/2" Dr. Impact Socket (464010 ~ 464028)
 3/8 - 7/16 - 1/2 - 9/16 -
 5/8 - 11/16 - 3/4 - 13/16 - 7/8" 



 1350g  20 Sets / 28 Kgs / 0.64 CUFT



IS-422S 22pcs SAE Impact Socket Set

22  1/2" Dr. Impact Socket (464010 ~ 464048) 



5/16 - 3/8 - 7/16 - 1/2 - 9/16 -
 19/32 - 5/8 - 11/16 - 3/4 - 25/32 -
 13/16 - 7/8 - 15/16 - 1" - 1 1/16 -
 1 1/8 - 1 3/16 - 1 1/4 - 1 5/16 -
 1 3/8 - 1 7/16 - 1 1/2"  4330g  3 Sets / 14 Kgs / 0.82 CUFT



CM-007 10pcs SAE Deep Impact Socket Set

10  1/2" Dr. Deep Socket (467814 ~ 467832) 



7/16 - 1/2 - 9/16 - 5/8 -
 11/16 - 3/4 - 13/16 -
 7/8 - 15/16 - 1"  2800g  10 Sets / 29 Kgs / 0.52 CUFT



CM-031 13pcs SAE Deep Impact Socket Set

13  1/2" Dr. Deep Socket (467814 ~ 467840) 



7/16 - 1/2 - 9/16 - 5/8 - 11/16 -
 3/4 - 13/16 - 7/8 - 15/16 - 1" -
 1 1/16 - 1 1/8 - 1 1/4"  4500g  4 Sets / 19 Kgs / 0.43 CUFT





DI-422S 22pcs SAE Deep Impact Socket Set

22  1/2" Dr. Socket (467810 ~ 467848) 

5/16 - 3/8 - 7/16 - 1/2 - 9/16 -
 19/32 - 5/8 - 11/16 - 3/4 - 25/32 -
 13/16 - 7/8 - 15/16 - 1" - 1 1/16 -
 1 1/8 - 1 3/16 - 1 1/4 - 1 5/16 -
 1 3/8 - 1 7/16 - 1 1/2"  6700g  3 Sets / 21 Kgs / 0.82 CUFT



GS-434S 34pcs Master SAE Deep Impact Socket Set



16  1/2" Dr. Socket (464010 ~ 464040) 

5/16 - 3/8 - 7/16 - 1/2 - 9/16 - 5/8 -
 11/16 - 3/4 - 13/16 - 7/8 - 15/16 - 1" -
 1 1/16 - 1 1/8 - 1 3/16 - 1 1/4"
 16  1/2" Dr. Deep Socket (467810 ~ 467840)
 5/16 - 3/8 - 7/16 - 1/2 - 9/16 - 5/8 -
 11/16 - 3/4 - 13/16 - 7/8 - 15/16 - 1" -
 1 1/16 - 1 1/8 - 1 3/16 - 1 1/4"
 1  1/2" Dr. Universal Joint (700108)
 1  1/2" Dr. Extension (480036MB)  7500g  3 Sets / 23.5 Kgs / 1.16 CUFT

1/2" Dr. Thin Wall Impact Socket Sets



DI-415M 15pcs Metric Deep Thin Wall Impact Socket Set



15  1/2" Dr. Semi-Deep Thin Wall Socket (445210 ~ 445224) 

10 - 11 - 12 - 13 - 14 -
 15 - 16 - 17 - 18 - 19 -
 20 - 21 - 22 - 23 - 24mm  2100g  10 Sets / 22 Kgs / 0.93 CUFT



1/2" Dr. Thin Wall Impact Socket Sets



GS-415M 15pcs Metric Thin Wall Impact Socket Set

15  1/2" Dr. Thin Wall Socket (453810 ~ 453824) 

10 - 11 - 12 - 13 - 14 -
 15 - 16 - 17 - 18 - 19 -
 20 - 21 - 22 - 23 - 24mm  1500g  10 Sets / 16 Kgs / 0.6 CUFT

DI-404M 4pcs Metric Spindle Nut Impact Socket Set

4  1/2" Dr. Deep Thin Wall Socket (448530 ~ 448536) 



30 - 32 - 34 - 36mm  2000g  12 Sets / 25 Kgs / 0.85 CUFT



DI-408M 8pcs Metric Spindle Nut Impact Socket Set

11  1/2" Dr. Deep Thin Wall Socket (448529 ~ 448539) 

29 - 30 - 32 - 34 -
 35 - 36 - 38 - 39mm  4500g  6 Sets / 28 Kgs / 1.39 CUFT

DI-417MD 17pcs Metric Deep Thin Wall Impact Socket Set

17  1/2" Dr. Deep Thin Wall Socket (448508 ~ 448524) 

8 - 9 - 10 - 11 - 12 - 13 - 14 -
 15 - 16 - 17 - 18 - 19 - 20 -
 21 - 22 - 23 - 24mm  3340g  5 Sets / 18 Kgs / 0.93 CUFT



1/2" Dr. Swivel Impact Socket Sets



TG-411M 11pcs Metric Swivel Impact Socket Set

11  1/2" Dr. Swivel Socket (480011M ~ 480022M) 



11 - 12 - 13 - 14 - 15 - 16 - 17 -
 18 - 19 - 21 - 22mm  2250g  12 Sets / 28 Kgs / 0.73 CUFT



TG-411MD 11pcs Metric Deep Swivel Impact Socket Set

11  1/2" Dr. Deep Swivel Socket (480011MD ~ 480022MD) 



11 - 12 - 13 - 14 - 15 - 16 - 17 -
 18 - 19 - 21 - 22mm  3250g  8 Sets / 27.5 Kgs / 0.73 CUFT



TG-408S 8pcs SAE Swivel Impact Socket Set

8  1/2" Dr. Swivel Socket (480024 ~ 480031) 

7/16 - 1/2 - 9/16 - 5/8 - 11/16 -
 3/4 - 13/16 - 7/8"  1710g  12 Sets / 22 Kgs / 0.7 CUFT

TG-408SD 8pcs SAE Deep Swivel Impact Socket Set

8  1/2" Dr. Swivel Socket (480024D ~ 480031D) 

7/16 - 1/2 - 9/16 - 5/8 - 11/16 -
 3/4 - 13/16 - 7/8"  2350g  8 Sets / 20.5 Kgs / 0.7 CUFT

3/4" Dr. Impact Sockets

6 pt. Metric Impact Sockets



ITEM NO.	Size mm	Length mm
645217	17	51
645218	18	51
645219	19	51
645220	20	51
645221	21	51
645222	22	51
645223	23	51
645224	24	51
645225	25	54
645226	26	54
645227	27	54
645228	28	54
645229	29	54
645230	30	54
645231	31	54
645232	32	57
645233	33	57
645234	34	57
645235	35	57
645236	36	57
645237	37	57
645238	38	57
645239	39	58
645240	40	58
645241	41	58
645242	42	60
645243	43	60
645244	44	63
645245	45	63
645246	46	63
645247	47	65
645248	48	65
645249	49	65
645250	50	68
645251	51	68
645252	52	70
645253	53	70
645254	54	73
645255	55	73
645256	56	73
645257	57	73
645258	58	73
645259	59	73
645260	60	80
645261	61	80
645262	62	80
645263	63	80
645264	64	80
645265	65	85
645266	66	85
645267	67	85
645268	68	85
645269	69	85
645270	70	90
645271	71	90
645272	72	90
645273	73	90
645274	74	90
645275	75	90
645276	76	90

6 pt. Metric Deep Impact Sockets



ITEM NO.	Size mm	Length mm
649517	17	90
649518	18	90
649519	19	90
649520	20	90
649521	21	90
649522	22	90
649523	23	90
649524	24	90
649525	25	90
649526	26	90
649527	27	90
649528	28	90
649529	29	90
649530	30	90
649531	31	90
649532	32	90
649533	33	90
649534	34	90
649535	35	90
649536	36	90
649537	37	90
649538	38	90
649539	39	90
649540	40	90
649541	41	90
649542	42	90
649543	43	90
649544	44	90
649545	45	95
649546	46	95
649547	47	95
649548	48	100
649549	49	100
649550	50	100
649551	51	100
649552	52	100
649556	56	100
649557	57	100
649558	58	100
649559	59	105
649560	60	105
649561	61	105
649562	62	105
649563	63	105
649564	64	105
649565	65	105
649566	66	105
649567	67	105
649568	68	105
649569	69	105
645270	70	110
649571	71	110
649572	72	110
649573	73	110
649574	74	110
649575	75	110
649576	76	110

3/4" Dr. Impact Sockets

6 pt. SAE Impact Sockets



ITEM NO.	Size Inch	Length mm
665222	11/16	51
665224	3/4	51
665225	25/32	51
665226	13/16	51
665228	7/8	51
665230	15/16	51
665232	1	54
665234	1-1/16	54
665236	1-1/8	54
665238	1-3/16	54
665240	1-1/4	57
665242	1-5/16	57
665244	1-3/8	57
665246	1-7/16	57
665248	1-1/2	57
665250	1-9/16	58
665252	1-5/8	58
665254	1-11/16	60
665256	1-3/4	63
665258	1-13/16	63
665260	1-7/8	65
665262	1-15/16	65
665264	2	68
665266	2-1/16	70
665268	2-1/8	73
665270	2-3/16	73
665272	2-1/4	73
665274	2-5/16	73
665276	2-3/8	80
665278	2-7/16	80
665280	2-1/2	80
665282	2-9/16	85
665284	2-5/8	85
665286	2-11/16	85
665288	2-3/4	90
665290	2-13/16	90
665292	2-7/8	90
665294	2-15/16	90
665296	3	90

6 pt. SAE Deep Impact Sockets



ITEM NO.	Size Inch	Length mm
669522	11/16	90
669524	3/4	90
669525	25/32	90
669526	13/16	90
669528	7/8	90
669530	15/16	90
669532	1	90
669534	1-1/16	90
669534T*	1-1/16	90
669536	1-1/8	90
669536T*	1-1/8	90
669538	1-3/16	90
669540	1-1/4	90
669540T*	1-1/4	90
669542	1-5/16	90
669544	1-3/8	90
669546	1-7/16	90
669548	1-1/2	90
669550	1-9/16	90
669552	1-5/8	90
669554	1-11/16	90
669556	1-3/4	95
669558	1-13/16	95
669560	1-7/8	100
669562	1-15/16	100
669564	2	100
669566	2-1/16	100
669568	2-1/8	100
669570	2-3/16	100
669572	2-1/4	100
669574	2-5/16	100
669576	2-3/8	105
669578	2-7/16	105
669580	2-1/2	105
669582	2-9/16	105
669584	2-5/8	105
669586	2-11/16	105
669588	2-3/4	110
669590	2-13/16	110
669592	2-7/8	110
669594	2-15/16	110
669596	3	110

* Thin Wall Sockets

3/4" Dr. Accessories



A Impact Adapters

ITEM NO.	Female Drive	Male Drive	Retention Device	L mm
640604	3/4"	1/2"	Pin	63
640604B	3/4"	1/2"	Ball	63
640608	3/4"	1"	Pin	65
640608B	3/4"	1"	Ball	65



C Impact Extension Bars

ITEM NO.	Retention Device	Length mm (Inch)
640100	Pin	100 (4")
640100B	Ball	100 (4")
640150	Pin	150 (6")
640150B	Ball	150 (6")
640200	Pin	200 (8")
640200B	Ball	200 (8")
640250	Pin	250 (10")
640250B	Ball	250 (10")



B Impact Universal Joints

ITEM NO.	Retention Device	Outside Diameter mm	Length mm
640606	Pin	44 mm	110
640606B	Ball	44 mm	110

Impact Sockets

3/4" Dr. Impact Sockets

Metric Thin Wall Impact Sockets			SAE Thin Wall Impact Sockets		
ITEM NO.	Size mm	Length mm	ITEM NO.	Size Inch	Length mm
655217	17	51	695222	11/16	51
655218	18	51	695224	3/4	51
655219	19	51	695225	25/32	51
655220	20	51	695226	13/16	51
655221	21	51	695228	7/8	51
655222	22	51	695230	15/16	51
655223	23	51	695232	1	54
655224	24	51	695234	1-1/16	54
655225	25	54	695236	1-1/8	54
655226	26	54	695238	1-3/16	54
655227	27	54	695240	1-1/4	57
655228	28	54	695242	1-5/16	57
655229	29	54	695244	1-3/8	57
655230	30	54	695246	1-7/16	57
655231	31	54	695248	1-1/2	57
655232	32	57	695250	1-9/16	58
655233	33	57	695252	1-5/8	58
655234	34	57	695254	1-11/16	60
655235	35	57	695256	1-3/4	63
655236	36	57	695258	1-13/16	63
655237	37	57	695260	1-7/8	65
655238	38	57	695262	1-15/16	65
655239	39	58	695264	2	68
655240	40	58	695266	2-1/16	70
655241	41	58	695268	2-1/8	73
655242	42	60	695270	2-3/16	73
655243	43	60	695272	2-1/4	73
655244	44	63	695274	2-5/16	73
655245	45	63	695276	2-3/8	80
655246	46	63	695280	2-1/2	80
655247	47	65	695284	2-5/8	85
655248	48	65	695288	2-3/4	90
655249	49	65			
655250	50	68			
655251	51	68			
655252	52	70			
655253	53	70			
655254	54	73			
655255	55	73			
655256	56	73			
655257	57	73			
655258	58	73			
655259	59	73			
655260	60	80			
655263	63	80			
655265	65	85			
645270	70	90			

3/4" Dr. Impact Socket Sets

CM-022 8pcs Metric Impact Socket Set

8 3/4" Dr. Socket (645226 ~ 645238)
26 - 27 - 29 - 30 - 32 - 35 - 36 - 38mm

 6 pt.

 4160g  6 Sets / 26 Kgs / 0.62 CUFT

IS-609E 9pcs Metric Impact Socket Set

9 3/4" Dr. Socket (645219 ~ 645236)
19 - 22 - 24 - 27 - 30 - 32 - 33 - 34 - 36mm

 6 pt.



 4000g  4 Sets / 17 Kgs / 0.85 CUFT

3/4" Dr. Impact Socket Sets

IS-617E 17pcs Metric Impact Socket Set

17 3/4" Dr. Socket (645219 ~ 645255)
19 - 21 - 22 - 24 - 27 - 30 - 32 - 33 - 34 - 35 - 36 - 38 - 40 - 41 - 46 - 50 - 55mm



 6 pt.

 9800g  2 Sets / 20.5 Kgs / 0.92 CUFT

IS-627M 27pcs Metric Impact Socket Set

27 3/4" Dr. Impact Socket (645217 ~ 645260)
17 - 19 - 20 - 21 - 22 - 23 - 24 - 27 - 30 - 31 - 32 - 33 - 34 - 35 - 36 - 37 - 38 - 40 - 41 - 45 - 46 - 48 - 50 - 54 - 55 - 57 - 60mm



 6 pt.

 18.5 Kg  1 Sets / 19 Kgs / 0.91 CUFT

IS-609DE 9pcs Metric Deep Impact Socket Set

9 3/4" Dr. Deep Socket (649519 ~ 649536)
19 - 22 - 24 - 27 - 30 - 32 - 33 - 34 - 36mm



 6 pt.

 6600g  3 Sets / 21 Kgs / 1.12 CUFT

DI-621M 21pcs Metric Deep Impact Socket Set

21 3/4" Dr. Deep Socket (649519 ~ 649550)
19 - 21 - 22 - 23 - 24 - 27 - 29 - 30 - 32 - 33 - 35 - 36 - 38 - 40 - 41 - 42 - 43 - 45 - 46 - 48 - 50mm



 6 pt.

 19 Kg  1 Sets / 20 Kgs / 0.91 CUFT

CM-021 8pcs SAE Impact Socket Set

8 3/4" Dr. Socket (665232 ~ 665248)
1" - 1 1/16 - 1 1/8 - 1 1/4 - 1 5/16 - 1 3/8 - 1 7/16 - 1 1/2"



 6 pt.

 4160g  6 Sets / 26 Kgs / 0.62 CUFT

IS-617S 17pcs SAE Impact Socket Set

17 3/4" Dr. Socket (665232 ~ 665264)
1" - 1 1/16 - 1 1/8 - 1 3/16 - 1 1/4 - 1 5/16 - 1 3/8 - 1 7/16 - 1 1/2 - 1 9/16 - 1 11/16 - 1 3/4 - 1 5/8 - 1 13/16 - 1 7/8 - 1 15/16 - 2"



 6 pt.

 11 Kg  2 Sets / 23 Kgs / 0.92 CUFT

IS-627S 27pcs SAE Impact Socket Set

27 3/4" Dr. Impact Socket (665224 ~ 665276)
3/4 - 25/32 - 13/16 - 7/8 - 15/16 - 1" - 1 1/16 - 1 1/8 - 1 3/16 - 1 1/4 - 1 5/16 - 1 3/8 - 1 7/16 - 1 1/2 - 1 9/16 - 1 5/8 - 1 11/16 - 1 3/4 - 1 13/16 - 1 7/8 - 1 15/16 - 2" - 2 1/16 - 2 1/8 - 2 3/16 - 2 1/4 - 2 3/8"



 6 pt.

 20 Kg  1 Sets / 21 Kgs / 0.91 CUFT

DI-621S 21pcs SAE Deep Impact Socket Set

21 3/4" Dr. deep impact socket (669524 ~ 669564)
3/4 - 13/16 - 7/8 - 15/16 - 1" - 1 1/16 - 1 1/8 - 1 3/16 - 1 1/4 - 1 5/16 - 1 3/8 - 1 7/16 - 1 1/2 - 1 9/16 - 1 5/8 - 1 11/16 - 1 3/4 - 1 13/16 - 1 7/8 - 1 15/16 - 2"

 6 pt.

 19.5 Kg  1 Set / 20.5 Kgs / 0.91 CUFT

1" Dr. Impact Sockets

6 pt. Metric Impact Sockets



6 pt. Metric Deep Impact Sockets



ITEM NO.	Size mm	Length mm
847017	17	60
847018	18	60
847019	19	60
847020	20	60
847021	21	60
847022	22	60
847023	23	60
847024	24	60
847025	25	60
847026	26	60
847027	27	60
847028	28	60
847029	29	60
847030	30	62
847031	31	62
847032	32	63
847033	33	63
847034	34	63
847035	35	63
847036	36	67
847037	37	67
847038	38	67
847039	39	67
847040	40	67
847041	41	70
847042	42	70
847043	43	70
847044	44	70
847045	45	70
847046	46	70
847047	47	70
847048	48	70
847049	49	70
847050	50	70
847051	51	70
847052	52	82
847053	53	82
847054	54	82
847055	55	87
847056	56	87
847057	57	87
847058	58	87
847059	59	87
847060	60	91
847061	61	91
847062	62	91
847063	63	91
847064	64	91
847065	65	95
847066	66	95
847067	67	95
847068	68	95
847069	69	95
847070	70	100
847071	71	100
847072	72	100
847073	73	100
847074	74	100
847075	75	105
847076	76	105
847077	77	105
847078	78	105
847079	79	105
847080	80	105
847082	82	105
847083	83	105
847085	85	110
847090	90	110
847095	95	120
847100	100	120
847105	105	120
847110	110	120
847115	115	120

ITEM NO.	Size mm	Length mm
849517	17	90
849518	18	90
849519	19	90
849520	20	90
849521	21	90
849522	22	90
849523	23	90
849524	24	90
849525	25	90
849526	26	90
849527	27	90
849528	28	90
849529	29	90
849530	30	90
849531	31	90
849532	32	90
849533	33	90
849534	34	90
849535	35	90
849536	36	90
849537	37	90
849538	38	90
849539	39	90
849540	40	90
849541	41	90
849542	42	90
849543	43	90
849544	44	90
849545	45	95
849546	46	100
849547	47	100
849548	48	100
849549	49	100
849550	50	100
849551	51	100
849552	52	100
849553	53	100
849554	54	100
849555	55	110
849556	56	110
849557	57	110
849558	58	110
849559	59	110
849560	60	110
849561	61	110
849562	62	110
849563	63	120
849564	64	120
849565	65	120
849566	66	120
849567	67	120
849568	68	120
849569	69	120
849570	70	125
849571	71	125
849572	72	125
849573	73	125
849574	74	125
849575	75	150
849576	76	150
849577	77	150
849578	78	150
849579	79	150
849580	80	150
849582	82	150
849583	83	150
849585	85	160
849590	90	160
849595	95	160
849600	100	160
849605	105	160
849610	110	160
849615	115	160

1" Dr. Impact Sockets

6 pt. SAE Impact Sockets



6 pt. SAE Deep Impact Sockets



ITEM NO.	Size Inch	Length mm
867024	3/4	60
867025	25/32	60
867026	13/16	60
867028	7/8	60
867030	15/16	60
867032	1	60
867034	1-1/16	60
867036	1-1/8	60
867038	1-3/16	62
867040	1-1/4	63
867042	1-5/16	63
867044	1-3/8	63
867046	1-7/16	67
867048	1-1/2	67
867050	1-9/16	67
867052	1-5/8	70
867054	1-11/16	70
867056	1-3/4	70
867058	1-13/16	70
867060	1-7/8	70
867062	1-15/16	70
867064	2	70
867066	2-1/16	82
867068	2-1/8	82
867070	2-3/16	87
867072	2-1/4	87
867074	2-5/16	87
867076	2-3/8	91
867078	2-7/16	91
867080	2-1/2	91
867082	2-9/16	95
867084	2-5/8	95
867086	2-11/16	95
867088	2-3/4	100
867090	2-13/16	100
867092	2-7/8	100
867094	2-15/16	105
867096	3	105
867098	3-1/16	105
867100	3-1/8	105
867102	3-3/16	105
867104	3-1/4	105
867106	3-5/16	105
867108	3-3/8	110
867110	3-7/16	110
867112	3-1/2	110
867114	3-9/16	110
867116	3-5/8	110
867118	3-11/16	110
867120	3-3/4	120
867122	3-13/16	120
867124	3-7/8	120
867126	3-15/16	120
867128	4	120
867130	4-1/16	120
867132	4-1/8	120
867134	4-3/16	120
867136	4-1/4	120
867138	4-5/16	120
867140	4-3/8	120
867142	4-7/16	120
867144	4-1/2	120

ITEM NO.	Size Inch	Length mm
869524	3/4	90
869525	25/32	90
869526	13/16	90
869528	7/8	90
869530	15/16	90
869532	1	90
869534	1-1/16	90
869534*	1-1/16	90
869536	1-1/8	90
869536*	1-1/8	90
869538	1-3/16	90
869540	1-1/4	90
869540*	1-1/4	90
869542	1-5/16	90
869544	1-3/8	90
869546	1-7/16	90
869548	1-1/2	90
869550	1-9/16	90
869552	1-5/8	90
869554	1-11/16	90
869556	1-3/4	95
869558	1-13/16	100
869560	1-7/8	100
869562	1-15/16	100
869564	2	100
869566	2-1/16	100
869568	2-1/8	100
869570	2-3/16	110
869572	2-1/4	110
869574	2-5/16	110
869576	2-3/8	110
869578	2-7/16	110
869580	2-1/2	120
869582	2-9/16	120
869584	2-5/8	120
869586	2-11/16	120
869588	2-3/4	125
869590	2-13/16	125
869592	2-7/8	125
869594	2-15/16	150
869596	3	150
869598	3-1/16	150
869600	3-1/8	150
869602	3-3/16	150
869604	3-1/4	150
869606	3-5/16	150
869608	3-3/8	160
869610	3-7/16	160
869612	3-1/2	160
869614	3-9/16	160
869616	3-5/8	160
869618	3-11/16	160
869620	3-3/4	160
869622	3-13/16	160
869624	3-7/8	160
869626	3-15/16	160
869628	4	160
869630	4-1/16	160
869632	4-1/8	160
869634	4-3/16	160
869636	4-1/4	160
869638	4-5/16	160
869640	4-3/8	160
869642	4-7/16	160
869644	4-1/2	160

*Thin Wall Sockets

Impact Sockets

1" Dr. Impact Sockets & Accessories



6 pt.
Metric
Thin Wall
Impact Sockets

ITEM NO.	Size mm	Length mm
848022	22	68
848023	23	68
848024	24	68
848025	25	68
848026	26	68
848027	27	68
848028	28	73
848029	29	73
848030	30	73
848032	32	73
848033	33	73
848034	34	73
848035	35	76
848036	36	76
848038	38	80
848041	41	80

A Impact Adapters

ITEM NO.	Female Drive	Male Drive	Retention Device	L mm
841006	1"	3/4"	Pin	70
841006B	1"	3/4"	Ball	70
841012	1"	1-1/2"	Pin	80
841012B	1"	1-1/2"	Ball	80

B Impact Universal Joints

ITEM NO.	Retention Device	Outside Diameter	Length mm
840808	Pin	52 mm	130
840808B	Ball	52 mm	130

C Impact Extension Bars

ITEM NO.	Retention Device	Length mm (Inch)
840150	Pin	150 (6")
840150B	Ball	150 (6")
841064	Pin	200 (8")
841064B	Ball	200 (8")
840250	Pin	250 (10")
840250B	Ball	250 (10")
840400	Pin	400 (16")
840400B	Ball	400 (16")

1" Dr. Impact Socket Sets

CM-808M 8pcs Metric Impact Socket Set

8 1" Dr. Socket (847022 ~ 847038)
22 - 24 - 27 - 30 -
32 - 33 - 35 - 38mm

6 pt.

6000g 4 Sets / 25 Kgs / 0.6 CUFT

CM-108M3 8pcs Metric Impact Socket Set

5 1" Dr. Socket (847027 ~ 847041)
27 - 32 - 35 - 38 - 41mm

3 1" Dr. Budd Wheel Socket
(846017S ~ 846021S)
17 - 19 - 21mm Square

6 pt.
4 pt.

6500g 4 Sets / 27 Kgs / 0.6 CUFT

CD-108M5 8pcs Metric Deep Impact Socket Set

3 1" Dr. Socket (847027 ~ 847033)
27 - 30 - 33mm

3 1" Dr. Deep Socket
(849535 ~ 849541)
35 - 38 - 41mm

2 1" Dr. Budd Wheel Socket
(846019S ~ 846021S)
19 - 21mm Square

6 pt.
4 pt.

7100g 4 Sets / 29.5 Kgs / 0.69 CUFT

CD-808MD 8pcs Metric Deep Impact Socket Set

8 1" Dr. Deep Socket (849522 ~ 849538)
22 - 24 - 27 - 30 -
32 - 33 - 35 - 38mm

6 pt.

8600g 2 Sets / 18.5 Kgs / 0.4 CUFT

1" Dr. Impact Socket Sets

IS-817M 17pcs Metric Impact Socket Set

17 1" Dr. Socket (847024 ~ 847075)
24 - 27 - 30 - 32 - 33 - 35 -
36 - 38 - 41 - 46 - 50 - 54 -
55 - 60 - 65 - 70 - 75mm

6 pt.

21.6 Kg 1 Set / 22.5 Kgs / 1.41 CUFT

CM-025-2 5pcs SAE Impact Socket Set

5 1" Dr. Socket (867036 ~ 867052)
1 1/8 - 1 1/4 - 1 3/8 -
1 1/2 - 1 5/8"

6 pt.

4330g 6 Sets / 27 Kgs / 0.47 CUFT

CM-808S 8pcs SAE Impact Socket Set

8 1" Dr. Socket (867028 ~ 867048)
7/8 - 15/16 - 1" - 1 1/16 - 1 1/8 -
1 3/16 - 1 1/4 - 1 1/2"

6 pt.

5900g 4 Sets / 24.5 Kgs / 0.6 CUFT

CM-108S3 8pcs SAE Impact Socket Set

6 1" Dr. Socket (867034 ~ 867048)
1 1/16 - 1 1/8 - 1 3/16 -
1 1/4 - 1 3/8 - 1 1/2"

2 1" Dr. Budd Wheel Socket
(846024S ~ 866026S)
3/4 - 13/16" Square

6 pt.
4 pt.

6500g 4 Sets / 27 Kgs / 0.6 CUFT

CM-029 9pcs SAE Impact Socket Set

9 1" Dr. Socket (867032 ~ 867064)
1" - 1 1/8 - 1 1/4 - 1 3/8 - 1 1/2 -
1 5/8 - 1 3/4 - 1 7/8 - 2"

6 pt.

7250g 4 Sets / 30 Kgs / 0.6 CUFT

CM-037-1 7pcs SAE Deep Impact Socket Set

6 1" Dr. Deep Socket (869530 ~ 869548)
15/16 - 1" - 1 1/16 - 1 1/8 -
1 1/4 - 1 1/2"

1 1" Dr. Deep Budd Wheel Socket
(869526S) 13/16" Square

6 pt.
4 pt.

7000g 4 Sets / 29 Kgs / 0.62 CUFT

CD-108S5 8pcs SAE Deep Impact Socket Set

3 1" Dr. Socket (867034 ~ 867040)
1 1/16 - 1 1/8 - 1 1/4"

3 1" Dr. Deep Socket (869542 ~ 869548)
1 5/16 - 1 3/8 - 1 1/2"

2 1" Dr. Budd Wheel Socket
(866024S ~ 866026S)
3/4 - 13/16" Square

6 pt.
4 pt.

7250g 4 Sets / 30 Kgs / 0.62 CUFT

CD-808SD 8pcs SAE Deep Impact Socket Set

8 1" Dr. Deep Socket (869528 ~ 869548)
7/8 - 15/16 - 1" - 1 1/16 - 1 1/8 -
1 3/16 - 1 1/4 - 1 1/2"

6 pt.

8360g 2 Sets / 18 Kgs / 0.4 CUFT

IS-817S 17pcs SAE Impact Socket Set

17 1" Dr. Socket (867046 ~ 867100)
1 7/16 - 1 1/2 - 1 5/8 - 1 11/16 - 1 3/4 -
1 13/16 - 1 7/8 - 2" - 2 1/8 - 2 3/16 -
2 1/4 - 2 3/8 - 2 1/2 - 2 5/8 - 2 3/4 -
2 15/16 - 3 1/8"

6 pt.

27.7 Kg 1 Set / 28.5 Kgs / 1.41 CUFT

1-1/2" Dr. Jumbo Impact Sockets



6 pt. Metric Jumbo Impact Sockets

ITEM NO.	Size mm	Length mm
938441	41	80
938442	42	80
938443	43	80
938446	46	84
938450	50	84
938452	52	84
938454	54	84
938455	55	90
938458	58	90
938460	60	90
938463	63	95
938465	65	95
938470	70	100
938475	75	105
938480	80	110
938485	85	110
938490	90	112
938495	95	112
938500	100	115
938505	105	120
938510	110	124
938515	115	128
938520	120	132
938525	125	136
938530	130	140
938535	135	145
938540	140	150
938545	145	155
938550	150	160

6 pt. SAE Jumbo Impact Sockets

ITEM NO.	Size Inch	Length mm
938724	3-7/8	115
938726	3-15/16	115
938728	4	120
938730	4-1/16	120
938732	4-1/8	120
938734	4-3/16	120
938736	4-1/4	124
938738	4-5/16	124
938740	4-3/8	124
938742	4-7/16	124
938744	4-1/2	128
938746	4-9/16	128
938748	4-5/8	132
938750	4-11/16	132
938752	4-3/4	132
938754	4-13/16	132
938756	4-7/8	136
938758	4-15/16	136
938760	5	140
938762	5-1/16	140
938764	5-1/8	140
938766	5-3/16	140
938768	5-1/4	145
938770	5-5/16	145
938772	5-3/8	145
938774	5-7/16	150
938776	5-1/2	150
938778	5-9/16	150
938780	5-5/8	155
938782	5-11/16	155
938784	5-3/4	155
938786	5-13/16	160
938788	5-7/8	160
938790	5-15/16	160
938792	6	160
938794	6-1/16	165
938796	6-1/8	165
938798	6-3/16	165
938800	6-1/4	170
938802	6-5/16	170
938804	6-3/8	170
938806	6-7/16	170
938808	6-1/2	175

6 pt. SAE Jumbo Impact Sockets

ITEM NO.	Size Inch	Length mm
938652	1-5/8	80
938654	1-11/16	80
938656	1-3/4	80
938658	1-13/16	84
938660	1-7/8	84
938662	1-15/16	84
938664	2	84
938666	2-1/16	84
938668	2-1/8	84
938670	2-3/16	90
938672	2-1/4	90
938674	2-5/16	90
938676	2-3/8	90
938678	2-7/16	95
938680	2-1/2	95
938682	2-9/16	95
938684	2-5/8	100
938686	2-11/16	100
938688	2-3/4	100
938690	2-13/16	105
938692	2-7/8	105
938694	2-15/16	105
938696	3	105
938698	3-1/16	105
938700	3-1/8	110
938702	3-3/16	110
938704	3-1/4	110
938706	3-5/16	110
938708	3-3/8	110
938710	3-7/16	112
938712	3-1/2	112
938714	3-9/16	112
938716	3-5/8	112
938718	3-11/16	112
938720	3-3/4	112
938722	3-13/16	115

1-1/2" Dr. Accessories

A Impact Adapters

ITEM NO.	Female Drive	Male Drive	Length mm
938008	1-1/2"	1"	98
938020	1-1/2"	2-1/2"	125

B Impact Extension Bars

ITEM NO.	Female Drive	Length mm
938175	1-1/2"	175
938250	1-1/2"	250
938330	1-1/2"	330

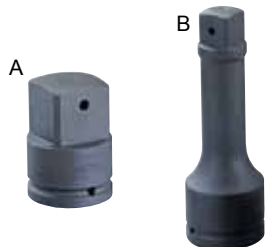

2-1/2" Dr. Jumbo Impact Sockets



6 pt. Metric Jumbo Impact Sockets

ITEM NO.	Size mm	Length mm
920460	60	125
920463	63	125
920465	65	125
920470	70	125
920475	75	125
920480	80	125
920485	85	132
920490	90	132
920495	95	140
920500	100	142
920505	105	146
920510	110	155
920515	115	158
920520	120	160
920525	125	165
920530	130	169
920535	135	175
920540	140	180
920545	145	183
920550	150	192
920555	155	196
920560	160	200
920565	165	204
920570	170	207
920575	175	211
920580	180	214
920585	185	218
920590	190	220
920595	195	222
920600	200	225
920605	205	230
920610	210	235
920615	215	240
920620	220	245
920625	225	250
920630	230	255
920635	235	260

6 pt. SAE Jumbo Impact Sockets

ITEM NO.	Size Inch	Length mm
920830	4-1/16	146
920832	4-1/8	146
920834	4-3/16	146
920836	4-1/4	155
920838	4-5/16	155
920840	4-3/8	155
920842	4-7/16	155
920844	4-1/2	158
920846	4-9/16	158
920848	4-5/8	160
920850	4-11/16	160
920852	4-3/4	160
920854	4-13/16	160
920856	4-7/8	165
920858	4-15/16	165
920860	5	165
920862	5-1/16	165
920864	5-1/8	169
920866	5-3/16	169
920868	5-1/4	175
920870	5-5/16	175
920872	5-3/8	180
920874	5-7/16	180
920876	5-1/2	180
920878	5-9/16	180
920880	5-5/8	180
920882	5-11/16	183
920884	5-3/4	183
920886	5-13/16	183
920888	5-7/8	192
920890	5-15/16	192
920892	6	192
920894	6-1/16	196
920896	6-1/8	196
920898	6-3/16	196
920900	6-1/4	196
920902	6-5/16	200
920904	6-3/8	200
920906	6-7/16	200
920908	6-1/2	204
920910	6-9/16	204
920912	6-5/8	204
920914	6-11/16	207
920916	6-3/4	207
920918	6-13/16	207
920920	6-7/8	211
920922	6-15/16	211
920924	7	213

6 pt. SAE Jumbo Impact Sockets

ITEM NO.	Size Inch	Length mm
920776	2-3/8	125
920778	2-7/16	125
920780	2-1/2	125
920782	2-9/16	125
920784	2-5/8	125
920786	2-11/16	125
920788	2-3/4	125
920790	2-13/16	125
920792	2-7/8	125
920794	2-15/16	125
920796	3	125
920798	3-1/16	125
920800	3-1/8	125
920802	3-3/16	125
920804	3-1/4	125
920806	3-5/16	132
920808	3-3/8	132
920810	3-7/16	132
920812	3-1/2	132
920814	3-9/16	132
920816	3-5/8	132
920818	3-11/16	132
920820	3-3/4	140
920822	3-13/16	140
920824	3-7/8	140
920826	3-15/16	142
920828	4	142

3-1/2" Dr. & #5 Spline Dr. Impact Sockets are also available.

Hand Sockets

1/4" Dr. Hand Sockets



ITEM NO.	Size mm	Length mm
222503	3	25
222504	4	25
2225045	4.5	25
222505	5	25
2225055	5.5	25
222506	6	25
222507	7	25
222508	8	25
222509	9	25
222510	10	25
222511	11	25
222512	12	25
222513	13	25
222514	14	25



ITEM NO.	Size mm	Length mm
225204	4	50
2252045	4.5	50
225205	5	50
2252055	5.5	50
225206	6	50
225207	7	50
225208	8	50
225209	9	50
225210	10	50
225211	11	50
225212	12	50
225213	13	50
225214	14	50



ITEM NO.	Size mm	Length mm
232505	5	25
2325055	5.5	25
232506	6	25
232507	7	25
232508	8	25
232509	9	25
232510	10	25
232511	11	25
232512	12	25
232513	13	25
232514	14	25



ITEM NO.	Size mm	Length mm
235205	5	50
2352055	5.5	50
235206	6	50
235207	7	50
235208	8	50
235209	9	50
235210	10	50
235211	11	50
235212	12	50
235213	13	50
235214	14	50



ITEM NO.	Size Inch	Length mm
282504	1/8	25
282506	3/16	25
282507	7/32	25
282508	1/4	25
282509	9/32	25
282510	5/16	25
282511	11/32	25
282512	3/8	25
282514	7/16	25
282516	1/2	25
282518	9/16	25



ITEM NO.	Size Inch	Length mm
285206	3/16	50
285207	7/32	50
285208	1/4	50
285209	9/32	50
285210	5/16	50
285211	11/32	50
285212	3/8	50
285214	7/16	50
285216	1/2	50
285218	9/16	50



ITEM NO.	Size Inch	Length mm
272506	3/16	25
272507	7/32	25
272508	1/4	25
272509	9/32	25
272510	5/16	25
272511	11/32	25
272512	3/8	25
272514	7/16	25
272516	1/2	25
272518	9/16	25



ITEM NO.	Size Inch	Length mm
275206	3/16	50
275207	7/32	50
275208	1/4	50
275209	9/32	50
275210	5/16	50
275211	11/32	50
275212	3/8	50
275214	7/16	50
275216	1/2	50
275218	9/16	50

1/4" Dr. Hand Sockets



ITEM NO.	Size mm	Length mm
253506	6	33
253507	7	33
253508	8	34
253509	9	34
253510	10	35
253511	11	36
253512	12	37
253513	13	37
253514	14	37



ITEM NO.	Size Inch	Length mm
263708	1/4	33
263710	5/16	34
263712	3/8	35
263714	7/16	36
263716	1/2	37
263718	9/16	37



ITEM NO.	Size mm	Length mm
232803	3	26
232804	4	26
232805	5	26
232806	6	26
232807	7	26
232808	8	26
232809	9	26
232810	10	26



ITEM NO.	Size Inch	Length mm
272804	1/8	26
272805	5/32	26
272806	3/16	26
272807	7/32	26
272808	1/4	26
272809	9/32	26
272810	5/16	26
272812	3/8	26



ITEM NO.	Size mm	Length mm
222640	0.8 x 4.0	26
222655	1.0 x 5.5	26
222665	1.2 x 6.5	26
222680	1.2 x 8.0	26
222685	1.6 x 8.5	26
222695	1.6 x 9.7	26



ITEM NO.	Size	Length mm
222601	#1	26
222602	#2	26
222603	#3	26
222604	#4	26



ITEM NO.	Size	Length mm
252504	E-4	22
252505	E-5	22
252506	E-6	22
252507	E-7	22
252508	E-8	22
252510	E-10	22
252511	E-11	22



ITEM NO.	Size	Length mm
242508	8mm	25
242510	10mm	25
262508	1/4"	25
262510	5/16"	25
262512	3/8"	25

1/4" Dr. Accessories



ITEM NO.	Length mm
280272S	165



ITEM NO.	Length mm
280272P	160



ITEM NO.	Length mm
280272	140



ITEM NO.	Length mm
280231S	165

1/4" Dr. Accessories

E 36 Teeth Ratchet w/ Quick Release

ITEM NO.	Length mm
280231P	160

F 36 Teeth Ratchet w/ Quick Release

ITEM NO.	Length mm
280231R	130

G 72 Teeth Rotor Ratchet

ITEM NO.	Length mm
281802S	175

H 72 Teeth Rotor Ratchet

ITEM NO.	Length mm
281802P	165

I 72 Teeth Rotor Ratchet

ITEM NO.	Length mm
281802	145

J 72 Teeth Flex Head Ratchet

ITEM NO.	Length mm
282262S	195

K 72 Teeth Flex Head Ratchet

ITEM NO.	Length mm
282262P	190

L 72 Teeth Flex Head Ratchet

ITEM NO.	Length mm
282262	170

M Hinge Handle

ITEM NO.	Length mm
280226S	180

N Hinge Handle

ITEM NO.	Length mm
280226P	175

O Hinge Handle

ITEM NO.	Length mm
280226A	150

P Hinge Handle

ITEM NO.	Length mm
280226	155

Q 24 Teeth Reversible Ratchet

ITEM NO.	Length mm
280222R	140

R 72 Teeth 1/4" & 3/8" Double Drive Ratchet

ITEM NO.	Length mm
380371	140

S Socket Driver

ITEM NO.	Length mm
506+0175	175

T Sliding T-Handle

ITEM NO.	Length mm
280020	150

U Folding Socket Driver

ITEM NO.	Length mm
220160	180

V Socket Driver

ITEM NO.	Length mm
220150	140

W Adapter

ITEM NO.	Female Drive	Male Drive	Length mm
280030	1/4"	3/8"	25

X Bit Holders

ITEM NO.	Hex Shank	Length mm
283508	1/4"	35
283510	5/16"	35

Y Extension Bars

ITEM NO.	Length mm (Inch)
220002	50 (2")
220003	75 (3")
220004	100 (4")
220006	150 (6")
220009	225 (9")
220012	300 (12")

Z Wobble Extension Bars

ITEM NO.	Length mm (Inch)
220002B	50 (2")
220004B	100 (4")
220006B	150 (6")
220009B	225 (9")

a Universal Joint

ITEM NO.	Length mm
280070	40

1/4" Dr. Hand Socket Sets

TW-211M 11pcs Metric Hand Socket Set

11 1/4" Dr. Socket (232505 ~ 232514)
5 - 5.5 - 6 - 7 - 8 - 9 - 10 - 11 - 12 - 13 - 14mm

240g 60 Sets / 15.5 Kgs / 1.58 CUFT

US-209M 9pcs Metric Universal Hand Socket Set

9 1/4" Dr. Universal Socket (253506 ~ 253514)
6 - 7 - 8 - 9 - 10 - 11 - 12 - 13 - 14mm

190g 80 Sets / 16.5 Kgs / 1.6 CUFT

GD-211M 11pcs Metric Deep Hand Socket Set

11 1/4" Dr. Deep Socket (225204 ~ -13)
4 - 5 - 5.5 - 6 - 7 - 8 - 9 - 10 - 11 - 12 - 13mm

400g 20 Sets / 9 Kgs / 0.71 CUFT

TW-211MD 11pcs Metric Deep Hand Socket Set

11 1/4" Dr. Deep Socket (235205 ~ -14)
5 - 5.5 - 6 - 7 - 8 - 9 - 10 - 11 - 12 - 13 - 14mm

370g 20 Sets / 8.5 Kgs / 0.71 CUFT

TW-210S 10pcs SAE Hand Socket Set

10 1/4" Dr. Socket (272506 ~ 272518)
3/16 - 7/32 - 1/4 - 9/32 - 5/16 - 11/32 - 3/8 - 7/16 - 1/2 - 9/16"

210g 60 Sets / 14 Kgs / 1.58 CUFT

US-206S 6pcs SAE Universal Hand Socket Set

6 1/4" Dr. Universal Socket (263708 ~ -18)
1/4 - 5/16 - 3/8 - 7/16 - 1/2 - 9/16"

140g 120 Sets / 18 Kgs / 1.6 CUFT

GD-210S 10pcs SAE Deep Hand Socket Set

10 1/4" Dr. Deep Socket (285206 ~ -18)
3/16 - 7/32 - 1/4 - 9/32 - 5/16 - 11/32 - 3/8 - 7/16 - 1/2 - 9/16"

360g 20 Sets / 9 Kgs / 0.71 CUFT

TW-210SD 10pcs SAE Deep Hand Socket Set

10 1/4" Dr. Deep Socket (275206 ~ -18)
3/16 - 7/32 - 1/4 - 9/32 - 5/16 - 11/32 - 3/8 - 7/16 - 1/2 - 9/16"

320g 20 Sets / 8.5 Kgs / 0.71 CUFT

XV-246M 46pcs Metric Hand Socket Set

13 1/4" Dr. Socket (V2040 ~ V2114)
4 - 4.5 - 5 - 5.5 - 6 - 7 - 8 - 9 - 10 - 11 - 12 - 13 - 14mm

3 1/4" Dr. Slotted Bit Socket (V2340 ~ -70) 4 - 5.5 - 7mm

3 1/4" Dr. Phillips Bit Socket (V2401 ~ -03) #1 - 2 - 3

3 1/4" Dr. Pozidriv Bit Socket (V2501 ~ -03) #1 - 2 - 3

6 1/4" Dr. Hex Bit Socket (V2230 ~ -80)
3 - 4 - 5 - 6 - 7 - 8mm

7 1/4" Dr. Star Bit Socket (V2608 ~ -40)
T8 - T10 - T15 - T20 - T25 - T30 - T40

4 Hex Key : 1.27, 1.5, 2, 2.5mm

1 Universal Joint (V2UJ2)

2 Ext. 50, 100mmL (V2E02, 04)

1 Sliding T-Handle (V2ST5)

1 Socket Driver (V2SD7)

1 Flexible Extension: 150mmL (V2SD7)

1 Quick Release Ratchet (V2RH6)

1300g 12 Sets / 17 Kgs / 1.16 CUFT

NEW

V-MARK

Hand Sockets

1/4" Dr. Hand Socket Sets

deep GS-255MS 55pcs Metric & SAE Deep Hand Socket Set 6 pt.

- 14 1/4" Dr. Socket (222503 ~ 222514)
3 - 4 - 4.5 - 5 - 5.5 - 6 - 7 - 8 - 9 - 10 - 11 - 12 - 13 - 14mm
- 13 1/4" Dr. Deep Socket (225204 ~ 225214)
4 - 4.5 - 5 - 5.5 - 6 - 7 - 8 - 9 - 10 - 11 - 12 - 13 - 14mm
- 11 1/4" Dr. Socket (282504 ~ 282518)
1/8 - 3/16 - 7/32 - 1/4 - 9/32 - 5/16 - 11/32 - 3/8 - 7/16 - 1/2 - 9/16"
- 10 1/4" Dr. Deep Socket (285206 ~ 285218)
3/16 - 7/32 - 1/4 - 9/32 - 5/16 - 11/32 - 3/8 - 7/16 - 1/2 - 9/16"
- 1 Adapter 1/4" F x 3/8" M (280030)
- 1 Universal Joint (280070)
- 1 1/4" Hex Shank Bit Holder (283508)
- 4 Extension 2 - 3 - 4 - 6" L (220002 ~ 220006)

1760g 12 Sets / 22 Kgs / 1.16 CUFT

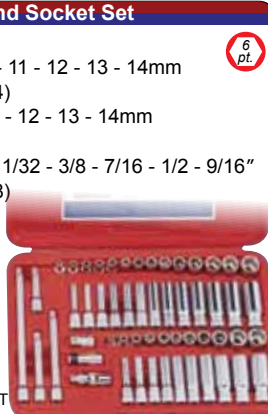

1/4" Dr. Socket Sets w/ Rubber Handle Ratchet

EU-228M 28pcs Metric Hand Socket Set 6 pt.

- 11 1/4" Dr. Socket (222504 ~ 222513)
4 - 5 - 5.5 - 6 - 7 - 8 - 9 - 10 - 11 - 12 - 13mm
- 3 Slotted (1140 ~ 1170) 4 - 6 - 7mm
- 3 Phillips (1101 ~ 1103) #1 - 2 - 3
- 4 Hex (2133 ~ 2136) 3 - 4 - 5 - 6mm
- 1 Universal Joint (280070)
- 1 1/4" Hex Shank Bit Holder (282408)
- 2 Ext. 50 - 150mm L (220002 ~ 220006)
- 1 Sliding T-Handle (280020)
- 1 Socket Driver (506+0175)
- 1 Quick Release Ratchet (280231S)

870g 20 Sets / 18.5 Kgs / 1.5 CUFT



deep EU-232M 32pcs Metric Deep Hand Socket Set 6 pt.

- 13 1/4" Dr. Socket (222503 ~ 222514)
3 - 4 - 5 - 5.5 - 6 - 7 - 8 - 9 - 10 - 11 - 12 - 13 - 14mm
- 12 1/4" Dr. Deep Socket (225204 ~ 225214)
4 - 5 - 5.5 - 6 - 7 - 8 - 9 - 10 - 11 - 12 - 13 - 14mm
- 1 Universal Joint (280070)
- 3 Ext. 50 - 100 - 150mm L (220002 ~ -06)
- 1 Sliding T-Handle (280020)
- 1 Socket Driver (506+0175)
- 1 Quick Release Ratchet (280231S)

1320g 12 Sets / 17 Kgs / 1.16 CUFT



EU-228S 28pcs SAE Hand Socket Set 6 pt.

- 11 1/4" Dr. Socket (282504 ~ 282518)
1/8 - 3/16 - 7/32 - 1/4 - 9/32 - 5/16 - 11/32 - 3/8 - 7/16 - 1/2 - 9/16"
- 3 Slotted (1140 ~ 1170) 4 - 6 - 7mm
- 3 Phillips (1101 ~ 1103) #1 - 2 - 3
- 4 Hex (3108 ~ 3124) 1/8 - 5/32 - 3/16 - 7/32"
- 1 Universal Joint (280070)
- 1 1/4" Hex Shank Bit Holder (282408)
- 2 Ext. 2 - 6" L (220002 ~ 220006)
- 1 Sliding T-Handle (280020)
- 1 Socket Driver (506+0175)
- 1 Quick Release Ratchet (280231S)

870g 20 Sets / 18.5 Kgs / 1.5 CUFT

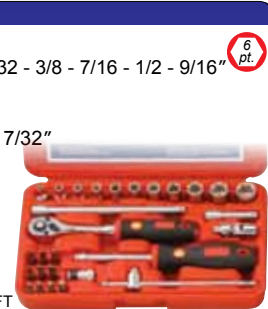

EU-230MS 30pcs Metric & SAE Hand Socket Set 6 pt.

- 13 1/4" Dr. Socket (222503 ~ 222514)
3 - 4 - 5 - 5.5 - 6 - 7 - 8 - 9 - 10 - 11 - 12 - 13 - 14mm
- 11 1/4" Dr. Socket (282504 ~ 282518)
1/8 - 3/16 - 7/32 - 1/4 - 9/32 - 5/16 - 11/32 - 3/8 - 7/16 - 1/2 - 9/16"
- 1 Universal Joint (280070)
- 2 Ext. 2 - 6" L (220002 ~ 220006)
- 1 Sliding T-Handle (280020)
- 1 Socket Driver (506+0175)
- 1 Quick Release Ratchet (280231S)

1030g 20 Sets / 22 Kgs / 1.5 CUFT



1/4" Dr. Socket Set w/ Plastic Handle Ratchet

EU-240M 40pcs Metric Hand Socket Set 6 pt.

- 11 1/4" Dr. Socket (222505 ~ 222514)
5 - 5.5 - 6 - 7 - 8 - 9 - 10 - 11 - 12 - 13 - 14mm
- 3 Slotted (1140 ~ 1170) 4 - 6 - 7mm
- 3 Phillips (1101 ~ 1103) #1 - 2 - 3
- 3 Posidriv (1211 ~ 1213) #1 - 2 - 3
- 6 Hex (2133 ~ 2138) 3 - 4 - 5 - 6 - 7 - 8mm
- 8 Tamperproof Star (7108 ~ 7140)
T8 - 10 - 15 - 20 - 25 - 27 - 30 - 40
- 1 Universal Joint (280070)
- 1 1/4" Shank Bit Holder (283508)
- 2 Ext. 50 - 100mm L (220002 ~ 220004)
- 1 Socket Driver (506+0175)
- 1 72 Teeth Ratchet (280272P)

1000g 10 Sets / 11 Kgs / 0.82 CUFT



1/4" Dr. Socket Sets w/ Chrome Handle Ratchet

GS-221M 21pcs Metric Deep Hand Socket Set 6 pt.

- 10 1/4" Dr. Socket (222505 ~ 222513)
5 - 5.5 - 6 - 7 - 8 - 9 - 10 - 11 - 12 - 13mm
- 8 1/4" Dr. Deep Socket (225206 ~ 225213)
6 - 7 - 8 - 9 - 10 - 11 - 12 - 13mm
- 1 Ext. 50mm L (220002)
- 1 Socket Driver (220150)
- 1 72 Teeth Ratchet (280272)

830g 20 Sets / 18 Kgs / 1.5 CUFT



deep GS-244MS 44pcs Metric & SAE Deep Hand Socket Set 6 pt.

- 13 1/4" Dr. Socket (222503 ~ 222514)
3 - 4 - 5 - 5.5 - 6 - 7 - 8 - 9 - 10 - 11 - 12 - 13 - 14mm
- 10 1/4" Dr. Deep Socket (225205 ~ 225214)
5.5 - 6 - 7 - 8 - 9 - 10 - 11 - 12 - 13 - 14mm
- 10 1/4" Dr. Socket (282506 ~ 282518)
3/16 - 7/32 - 1/4 - 9/32 - 5/16 - 11/32 - 3/8 - 7/16 - 1/2 - 9/16"
- 8 1/4" Dr. Deep Socket (285208 ~ 285218)
1/4 - 9/32 - 5/16 - 11/32 - 3/8 - 7/16 - 1/2 - 9/16"
- 2 Extension 2" - 6" L (220002 ~ 220006)
- 1 72 Teeth Ratchet (280272)

1500g 12 Sets / 19 Kgs / 1.16 CUFT

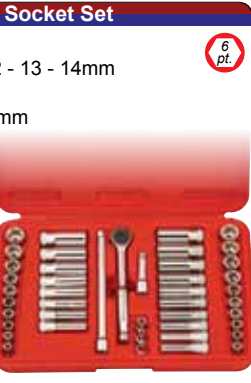

deep TW-242MS 42pcs Metric & SAE Deep Hand Socket Set 12 pt.

- 9 1/4" Dr. Socket (232506 ~ 232514)
6 - 7 - 8 - 9 - 10 - 11 - 12 - 13 - 14mm
- 11 1/4" Dr. Deep Socket (235205 ~ 235214)
5 - 5.5 - 6 - 7 - 8 - 9 - 10 - 11 - 12 - 13 - 14mm
- 10 1/4" Dr. Socket (272506 ~ 272518)
3/16 - 7/32 - 1/4 - 9/32 - 5/16 - 11/32 - 3/8 - 7/16 - 1/2 - 9/16"
- 8 1/4" Dr. Deep Socket (275208 ~ 275218)
1/4 - 9/32 - 5/16 - 11/32 - 3/8 - 7/16 - 1/2 - 9/16"
- 1 Universal Joint (280070)
- 2 Ext. 2" - 6" L (220002 ~ 220006)
- 1 Quick Release Ratchet (280231R)

1470g 12 Sets / 18.6 Kgs / 1.16 CUFT



1/4" Dr. Socket Sets w/ Knurled Handle Ratchet

GS-219M 19pcs Metric Hand Socket Set 6 pt. 6 pt.

- 11 1/4" Dr. Socket (222504 ~ 222512)
4 - 4.5 - 5 - 5.5 - 6 - 7 - 8 - 9 - 10 - 11 - 12mm
- 2 1/4" Dr. 8pt. Socket (242508 ~ 242510)
8 - 10mm
- 1 Universal Joint (280070)
- 2 Ext. 50 - 100mm L (220002 ~ 220004)
- 1 Sliding T-Handle (280020)
- 1 Socket Driver (220150)
- 1 Ratchet (280222R)

1150g 10 Sets / 12.5 Kgs / 0.77 CUFT



1/4" Dr. Socket Sets w/ Knurled Handle Ratchet

GS-229M 29pcs Metric Hand Socket Set

- 13 1/4" Dr. Socket (222504 ~ 222514)
4 - 4.5 - 5 - 5.5 - 6 - 7 - 8 - 9 - 10 - 11 - 12 - 13 - 14mm
- 3 1/4" Dr. Slotted Socket (222640 ~ -80)
4 - 5.5 - 8mm
- 3 1/4" Dr. Philips Socket (222601 ~ -03)
#1 - 2 - 3
- 5 1/4" Dr. Hex Socket (232803 ~ -08)
3 - 4 - 5 - 6 - 8mm
- 1 Universal Joint (280070)
- 1 Ext. 50mmL (220002)
- 1 Sliding T-Handle (280020)
- 1 Socket Driver (220150)
- 1 Ratchet (280222R)

850g 20 Sets / 18 Kgs / 1.5 CUFT



GS-239M 39pcs Metric Hand Socket Set

- 14 1/4" Dr. Socket (222503 ~ 222514)
3 - 4 - 4.5 - 5 - 5.5 - 6 - 7 - 8 - 9 - 10 - 11 - 12 - 13 - 14mm
- 2 1/4" Dr. 8pt. Socket (242508 ~ 242510)
8 - 10mm
- 6 1/4" Dr. Slotted Socket (222640 ~ -95)
4 - 5.5 - 6.5 - 8 - 8.5 - 9.7mm
- 4 1/4" Dr. Philips Socket (222601 ~ -04)
#1 - 2 - 3 - 4
- 8 1/4" Dr. Hex Socket (232803 ~ -10)
3 - 4 - 5 - 6 - 7 - 8 - 9 - 10mm
- 1 Universal Joint (280070)
- 1 Ext. 100mmL (220004)
- 1 Sliding T-Handle (280020)
- 1 Socket Driver (220150)
- 1 Ratchet (280222R)

1400g 10 Sets / 15 Kgs / 0.77 CUFT



deep GD-220M 20pcs Metric Deep Hand Socket Set

- 13 1/4" Dr. Deep Socket (225204 ~ 225214)
4 - 4.5 - 5 - 5.5 - 6 - 7 - 8 - 9 - 10 - 11 - 12 - 13 - 14mm
- 1 Universal Joint (280070)
- 2 Ext. 50 - 100mmL (220002 ~ 220004)
- 1 Sliding T-Handle (280020)
- 1 Socket Driver (220150)
- 1 Hinge Handle (280226A)
- 1 Ratchet (280222R)

1400g 10 Sets / 15 Kgs / 0.77 CUFT



GS-237S 37pcs SAE Hand Socket Set

- 11 1/4" Dr. Socket (282504 ~ 282518)
1/8 - 3/16 - 7/32 - 1/4 - 9/32 - 5/16 - 11/32 - 3/8 - 7/16 - 1/2 - 9/16"
- 3 1/4" Dr. 8pt. Socket (262508 ~ 262512)
1/4 - 5/16 - 3/8"
- 6 1/4" Dr. Slotted Socket (222640 ~ -95)
4 - 5.5 - 6.5 - 8 - 8.5 - 9.7mm
- 4 1/4" Dr. Philips Socket (222601 ~ -04)
#1 - 2 - 3 - 4
- 8 1/4" Dr. Hex Socket (272804 ~ -12)
1/8 - 5/32 - 3/16 - 7/32 - 1/4 - 9/32 - 5/16 - 3/8"
- 1 Universal Joint (280070)
- 1 Ext. 4"L (220004)
- 1 Sliding T-Handle (280020)
- 1 Socket Driver (220150)
- 1 Ratchet (280222R)

1350g 10 Sets / 14.5 Kgs / 0.77 CUFT





deep GD-217S 17pcs SAE Deep Hand Socket Set

- 10 1/4" Dr. Deep Socket (285206 ~ 285218)
3/16 - 7/32 - 1/4 - 9/32 - 5/16 - 11/32 - 3/8 - 7/16 - 1/2 - 9/16"
- 1 Universal Joint (280070)
- 2 Ext. 2 - 4"L (220002 ~ 220004)
- 1 Sliding T-Handle (280020)
- 1 Socket Driver (220150)
- 1 Hinge Handle (280226A)
- 1 Ratchet (280222R)



1350g 10 Sets / 15 Kgs / 0.77 CUFT





3/8" Dr. Hand Sockets

6 pt. Metric Hand Sockets  **6 pt. Metric Deep Hand Sockets** 

ITEM NO.	Size mm	Length mm	ITEM NO.	Size mm	Length mm
323206	6	28	326306	6	63
323207	7	28	326307	7	63
323208	8	28	326308	8	63
323209	9	28	326309	9	63
323210	10	28	326310	10	63
323211	11	30	326311	11	63
323212	12	30	326312	12	63
323213	13	30	326313	13	63
323214	14	30	326314	14	63
323215	15	30	326315	15	63
323216	16	30	326316	16	63
323217	17	32	326317	17	63
323218	18	32	326318	18	63
323219	19	32	326319	19	63
323220	20	32	326320	20	63
323221	21	32	326321	21	63
323222	22	32	326322	22	63

12 pt. Metric Hand Sockets  **12 pt. Metric Deep Hand Sockets** 

ITEM NO.	Size mm	Length mm	ITEM NO.	Size mm	Length mm
333206	6	28	336306	6	63
333207	7	28	336307	7	63
333208	8	28	336308	8	63
333209	9	28	336309	9	63
333210	10	28	336310	10	63
333211	11	30	336311	11	63
333212	12	30	336312	12	63
333213	13	30	336313	13	63
333214	14	30	336314	14	63
333215	15	30	336315	15	63
333216	16	30	336316	16	63
333217	17	32	336317	17	63
333218	18	32	336318	18	63
333219	19	32	336319	19	63
333220	20	32	336320	20	63
333221	21	32	336321	21	63
333222	22	32	336322	22	63

6 pt. SAE Hand Sockets  **6 pt. SAE Deep Hand Sockets** 

ITEM NO.	Size Inch	Length mm	ITEM NO.	Size Inch	Length mm
383208	1/4	28	386308	1/4	63
383210	5/16	28	386310	5/16	63
383211	11/32	28	386311	11/32	63
383212	3/8	28	386312	3/8	63
383214	7/16	30	386314	7/16	63
383216	1/2	30	386316	1/2	63
383218	9/16	30	386318	9/16	63
383219	19/32	30	386319	19/32	63
383220	5/8	30	386320	5/8	63
383222	11/16	32	386322	11/16	63
383224	3/4	32	386324	3/4	63
383225	25/32	32	386325	25/32	63
383226	13/16	32	386326	13/16	63
383228	7/8	32	386328	7/8	63

Hand Sockets

3/8" Dr. Hand Sockets

12 pt SAE Hand Sockets



ITEM NO.	Size Inch	Length mm
373208	1/4	28
373210	5/16	28
373211	11/32	28
373212	3/8	28
373214	7/16	30
373216	1/2	30
373218	9/16	30
373219	19/32	30
373220	5/8	30
373222	11/16	32
373224	3/4	32
373225	25/32	32
373226	13/16	32
373228	7/8	32

12 pt SAE Deep Hand Sockets



ITEM NO.	Size Inch	Length mm
376308	1/4	63
376310	5/16	63
376311	11/32	63
376312	3/8	63
376314	7/16	63
376316	1/2	63
376318	9/16	63
376319	19/32	63
376320	5/8	63
376322	11/16	63
376324	3/4	63
376325	25/32	63
376326	13/16	63
376328	7/8	63

12 pt Metric Universal Hand Sockets



ITEM NO.	Size mm	Length mm
355610	10	51
355611	11	51
355612	12	51
355613	13	51
355614	14	52
355615	15	53
355616	16	54
355617	17	54
355618	18	56
355619	19	56

12 pt SAE Universal Hand Sockets



ITEM NO.	Size Inch	Length mm
365612	3/8	51
365614	7/16	51
365616	1/2	51
365618	9/16	52
365620	5/8	54
365622	11/16	56
365624	3/4	56

E-Star Hand Sockets



ITEM NO.	Size	Length mm
353510	E-10	28
353511	E-11	28
353512	E-12	28
353514	E-14	28
353516	E-16	28
353518	E-18	30
353520	E-20	30

6 pt Spark Plug Sockets



ITEM NO.	Size mm (inch)	Length mm
326016	16.0 (5/8")	63
326021	20.6 (13/16")	63

6 pt Swivel Spark Plug Sockets



ITEM NO.	Size mm (inch)	Length mm
318516	16.0 (5/8")	90
318521	20.6 (13/16")	90

3/8" Dr. Accessories

A 72 Teeth Ratchet



ITEM NO.	Length mm
380372S	225

B 72 Teeth Ratchet



ITEM NO.	Length mm
380372P	225

C 72 Teeth Ratchet



ITEM NO.	Length mm
380372	200

D 36 Teeth Ratchet w/ Quick Release



ITEM NO.	Length mm
380331S	220

E 36 Teeth Ratchet w/ Quick Release



ITEM NO.	Length mm
380331P	210

F 36 Teeth Ratchet w/ Quick Release



ITEM NO.	Length mm
380331R	180

3/8" Dr. Accessories

G 72 Teeth Rotor Ratchet



ITEM NO.	Length mm
381803S	260

H 72 Teeth Rotor Ratchet



ITEM NO.	Length mm
381803P	250

I 72 Teeth Rotor Ratchet



ITEM NO.	Length mm
381803	225

J 72 Teeth Flex Head Ratchets



ITEM NO.	Length mm
383363S	260
383338S	310

K 72 Teeth Flex Head Ratchets



ITEM NO.	Length mm
383363P	250
383338P	300

L 72 Teeth Flex Head Ratchets



ITEM NO.	Length mm
383363	230
383338	280

M 72 Teeth Bent Handle Flex Head



ITEM NO.	Length mm
383383S	310

N 72 Teeth Bent Handle Flex Head

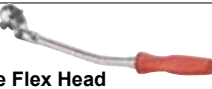

ITEM NO.	Length mm
383383P	310

O 72 Teeth Bent Handle Flex Head



ITEM NO.	Length mm
383383L	270

P Hinge Handle



ITEM NO.	Length mm
380336S	240
380338S	280

Q Hinge Handle



ITEM NO.	Length mm
380336P	230

R Hinge Handle

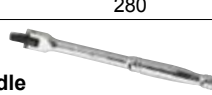

ITEM NO.	Length mm
380336	200

S Hinge Handle



ITEM NO.	Length mm
380336A	200

T 24 Teeth Reversible Ratchet

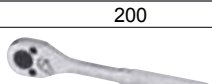

ITEM NO.	Length mm
380333R	180

U 24 Teeth Flex Head Ratchet



ITEM NO.	Length mm
380375	255

V Sliding T-Handle



ITEM NO.	Length mm
380030	250

W 72 Teeth Stubby Ratchet



ITEM NO.	Length mm
380370	100

X T-Handles (Quick Release)



ITEM NO.	Length mm
324203	420
327003	700

Y Speed Handle



ITEM NO.	Length mm
380400	400

Z T-Handles (Ball Joint)



ITEM NO.	Length mm
323503T	350
325003T	500

a T-Handles (Universal Joint)



ITEM NO.	Length mm
324203U	420
327003U	700

3/8" Dr. Accessories

b Bit Holders

ITEM NO.	Hex Shank	Length mm
383908	1/4"	39
384608	1/4"	46
383910	5/16"	39
384610	5/16"	46
383912	3/8"	39
323910	10mm	39

c Adapters

ITEM NO.	Female Drive	Male Drive	Length mm
320020	3/8"	1/4"	30
320040	3/8"	1/2"	35

d Universal Joint

ITEM NO.	Length mm
380070	54

e Extension Bars

ITEM NO.	Length mm (Inch)
320025	25 (1")
320045	45 (1-3/4")
320075	75 (3")
320150	150 (6")
320200	200 (8")
320250	250 (10")

f Wobble Extension Bars

ITEM NO.	Length mm (Inch)
320002B	45 (1-3/4")
320003B	75 (3")
320006B	150 (6")
320008B	200 (8")
320012B	300 (12")
320018B	450 (18")

3/8" Dr. Hand Socket Sets

GS-312M 12pcs Metric Hand Socket Set

12 3/8" Dr. Socket (323208 ~ 323219)
8 - 9 - 10 - 11 - 12 - 13 - 14 - 15 - 16 - 17 - 18 - 19mm

6 pt.

800g 40 Sets / 27 Kgs / 1.94 CUFT

TW-316M 16pcs Metric Hand Socket Set

16 3/8" Dr. Socket (333206 ~ 333221)
6 - 7 - 8 - 9 - 10 - 11 - 12 - 13 - 14 - 15 - 16 - 17 - 18 - 19 - 20 - 21mm

12 pt.

900g 20 Sets / 19 Kgs / 0.73 CUFT

US-310M 10pcs Metric Universal Hand Socket Set

10 3/8" Dr. Universal Socket (355610 ~ 355619)
10 - 11 - 12 - 13 - 14 - 15 - 16 - 17 - 18 - 19mm

12 pt.

670g 30 Sets / 21 Kgs / 1.21 CUFT

GD-312M 12pcs Metric Deep Hand Socket Set

12 3/8" Dr. Deep Socket (326308 ~ 326319)
8 - 9 - 10 - 11 - 12 - 13 - 14 - 15 - 16 - 17 - 18 - 19mm

6 pt.

1170g 24 Sets / 29 Kgs / 1.94 CUFT

TW-316MD 16pcs Metric Deep Hand Socket Set

16 3/8" Dr. Deep Socket (336306 ~ 336321)
6 - 7 - 8 - 9 - 10 - 11 - 12 - 13 - 14 - 15 - 16 - 17 - 18 - 19 - 20 - 21mm

12 pt.

1590g 12 Sets / 20 Kgs / 0.73 CUFT

GS-332M 32pcs Metric Deep Hand Socket Set

16 3/8" Dr. Socket (323207 ~ 323222)
7 - 8 - 9 - 10 - 11 - 12 - 13 - 14 - 15 - 16 - 17 - 18 - 19 - 20 - 21 - 22mm

16 3/8" Dr. Deep Socket (326307 ~ 326322)
7 - 8 - 9 - 10 - 11 - 12 - 13 - 14 - 15 - 16 - 17 - 18 - 19 - 20 - 21 - 22mm

6 pt.

1/3 Tray
2700g 5 Sets / 14.5 Kgs / 0.93 CUFT

3/8" Dr. Hand Socket Sets

GS-314S 14pcs SAE Hand Socket Set

14 3/8" Dr. Socket (383208 ~ 383228)
1/4 - 5/16 - 11/32 - 3/8 - 7/16 - 1/2 - 9/16 - 19/32 - 5/8 - 11/16 - 3/4 - 25/32 - 13/16 - 7/8"

6 pt.

800g 20 Sets / 17 Kgs / 0.92 CUFT

TW-314S 14pcs SAE Hand Socket Set

14 3/8" Dr. Socket (373208 ~ 373228)
1/4 - 5/16 - 11/32 - 3/8 - 7/16 - 1/2 - 9/16 - 19/32 - 5/8 - 11/16 - 3/4 - 25/32 - 13/16 - 7/8"

12 pt.

800g 20 Sets / 17 Kgs / 0.92 CUFT

US-307S 7pcs SAE Universal Hand Socket Set

7 3/8" Dr. Universal Socket (365612 ~ 365624)
3/8 - 7/16 - 1/2 - 9/16 - 5/8 - 11/16 - 3/4"

12 pt.

480g 20 Sets / 11 Kgs / 0.71 CUFT

GS-314SD 14pcs SAE Deep Hand Socket Set

14 3/8" Dr. Deep Socket (386308 ~ 386328)
1/4 - 5/16 - 11/32 - 3/8 - 7/16 - 1/2 - 9/16 - 19/32 - 5/8 - 11/16 - 3/4 - 25/32 - 13/16 - 7/8"

6 pt.

1170g 12 Sets / 18 Kgs / 0.73 CUFT

TW-314SD 14pcs SAE Deep Hand Socket Set

14 3/8" Dr. Deep Socket (376308 ~ 376328)
1/4 - 5/16 - 11/32 - 3/8 - 7/16 - 1/2 - 9/16 - 19/32 - 5/8 - 11/16 - 3/4 - 25/32 - 13/16 - 7/8"

12 pt.

1420g 12 Sets / 18 Kgs / 0.73 CUFT

GENIUS TOOLS comfort grip design

quick release design
securely holds sockets
while in use

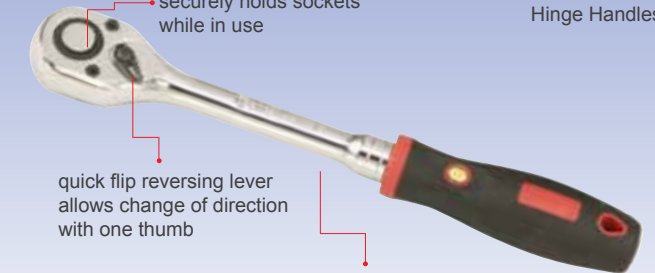

quick flip reversing lever
allows change of direction
with one thumb

5 degree swing arc
for work in confined
spaces

drop forged Chrome Vanadium
steel and Chrome plated for
corrosion resistance

rubber cushion grip
for added comfort
and control

rotor head design
allows 270° angle adjustment



available in
1/4", 3/8" & 1/2" Dr.
Rotor Ratchets
Quick Release Ratchets
Flex Head Ratchets
Hinge Handles

Hand Sockets

3/8" Dr. Socket Sets w/ Rubber Handle Ratchet

AC-359C* 59pcs Metric Deep Hand Socket & Bit Set 6 pt.

- 17 3/8" Dr. Socket (323206 ~ 323222)
6 - 7 - 8 - 9 - 10 - 11 - 12 - 13 - 14 - 15 - 16 - 17 - 18 - 19 - 20 - 21 - 22mm
- 9 3/8" Dr. Deep Socket (326308 ~ 326319)
8 - 10 - 11 - 12 - 13 - 14 - 15 - 17 - 19mm
- 3 Slotted (1150 ~ 1170) 5 - 6 - 7mm
- 3 Phillips (1101 ~ 1103) #1 - 2 - 3
- 3 Posidriv (1211 ~ 1213) #1 - 2 - 3
- 6 Hex (2133 ~ 2138) 3 - 4 - 5 - 6 - 7 - 8mm
- 9 Tamperproof Star (7110 ~ 7140)
T10 - 15 - 20 - 25 - 30 - 40 - 45 - 50 - 55
- 1 Adapter 3/8" F x 1/2" M (320040)
- 1 Universal Joint (380070)
- 1 1/4" Hex Shank Bit Holder (383908)
- 2 Spark Plug 16mm (5/8") - 20.6mm (13/16")
(326016 ~ 326021)
- 2 Ext. 75 - 200mmL (320075 ~ 320200)
- 1 1/4" Hex Shank Screwdriver Handle (280150)
- 1 Quick Release Ratchet (380331S)



 

3400g 4 Sets / 14.5 Kgs / 1.07 CUFT

**also available in 12 point sockets (AC-359B)*

EU-354M 54pcs Metric Deep Hand Socket & Bit Socket Set 6 pt. 12 pt.

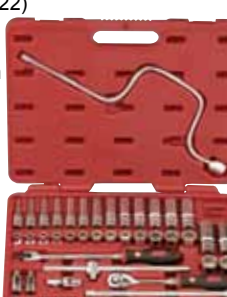
- 15 3/8" Dr. Socket (323207 ~ 323222)
7 - 8 - 9 - 10 - 11 - 12 - 13 - 14 - 15 - 16 - 17 - 18 - 19 - 21 - 22mm
- 15 3/8" Dr. 12pt. Deep Socket (336307 ~ 336322)
7 - 8 - 9 - 10 - 11 - 12 - 13 - 14 - 15 - 16 - 17 - 18 - 19 - 21 - 22mm
- 4 Slotted (1155 ~ 1290) 5.5 - 6.5 - 8 - 9mm
- 4 Phillips (1101 ~ 1124) #1 - 2 - 3 - 4
- 7 Hex Bit Socket (308+2133 ~ 340+2150)
3 - 4 - 5 - 6 - 7 - 8 - 10mm
- 1 Universal Joint (380070)
- 1 1/4" Hex Shank Bit Holder (383908)
- 1 5/16" Hex Shank Bit Holder (383910)
- 2 Ext. 150 - 250mmL (320150 ~ 320250)
- 1 Sliding T-Handle (380030)
- 1 Speed Handle (380400)
- 1 Hinge Handle (380338S)
- 1 Quick Release Ratchet (380331S)

 

5160g 4 Sets / 21.5 Kgs / 1.65 CUFT

3/8" Dr. Socket Sets w/ Chrome Handle Ratchet

GS-331M 31pcs Metric Hand Socket Set 6 pt.

- 12 3/8" Dr. Socket (323208 ~ -19)
8 - 9 - 10 - 11 - 12 - 13 - 14 - 15 - 16 - 17 - 18 - 19mm
- 12 3/8" Dr. Deep Socket (326308 ~ -19)
8 - 9 - 10 - 11 - 12 - 13 - 14 - 15 - 16 - 17 - 18 - 19mm
- 1 Universal Joint (380070)
- 4 Ext. 25 - 75 - 150 - 250mmL
(320025 ~ 320250)
- 1 Hinge Handle (380338P)
- 1 Quick Release Ratchet (380331R)



3300g 5 Sets / 17.5 Kgs / 1.01 CUFT

GS-347MS 47pcs Metric & SAE Hand Socket Set 6 pt.

- 14 3/8" Dr. Socket (323206 ~ 323219)
6 - 7 - 8 - 9 - 10 - 11 - 12 - 13 - 14 - 15 - 16 - 17 - 18 - 19mm
- 10 3/8" Dr. Deep Socket (326310 ~ 326319)
10 - 11 - 12 - 13 - 14 - 15 - 16 - 17 - 18 - 19mm
- 11 3/8" Dr. Socket (383208 ~ 383228)
1/4 - 5/16 - 3/8 - 7/16 - 1/2 - 9/16 - 5/8 - 11/16 - 3/4 - 13/16 - 7/8"
- 9 3/8" Dr. Deep Socket (386312 ~ 386328)
3/8 - 7/16 - 1/2 - 9/16 - 5/8 - 11/16 - 3/4 - 13/16 - 7/8"
- 2 Ext. 3 - 6"L (320075 ~ 320150)
- 1 72 Teeth Ratchet (380372)



3750g 4 Sets / 16 Kgs / 1.07 CUFT

3/8" Dr. Socket Sets w/ Plastic Handle Ratchet

EU-319M 19pcs Metric Hand Socket Set 6 pt.

- 14 3/8" Dr. Socket (323208 ~ 323222)
8 - 9 - 10 - 11 - 12 - 13 - 14 - 15 - 16 - 17 - 18 - 19 - 21 - 22mm
- 1 Universal Joint (380070)
- 3 Ext. 25 - 75 - 250mmL
(320025 ~ -250)
- 1 72 Teeth Ratchet (380372P)



1830g 10 Sets / 19.5 Kgs / 1.16 CUFT

3/8" Dr. Socket Sets w/ Knurled Handle Ratchet

GS-320M 20pcs Metric Hand Socket Set 6 pt.

- 13 3/8" Dr. Socket (323206 ~ 323221)
6 - 8 - 9 - 10 - 11 - 12 - 13 - 14 - 15 - 16 - 17 - 19 - 21mm
- 2 Spark Plug Socket 16 - 20.6mm
(326016 ~ 326021)
- 2 Ext. 75 - 200mmL (320075 ~ -200)
- 1 Sliding T-Handle (380030)
- 1 Hinge Handle (380336A)
- 1 Ratchet (380333R)



3000g 6 Sets / 19 Kgs / 0.7 CUFT

AC-359* 59pcs Metric Deep Hand Socket & Hex Bit Set 12 pt.

- 17 3/8" Dr. Socket (333206 ~ 333222)
6 - 7 - 8 - 9 - 10 - 11 - 12 - 13 - 14 - 15 - 16 - 17 - 18 - 19 - 20 - 21 - 22mm
- 9 3/8" Dr. Deep Socket (336308 ~ 336319)
8 - 10 - 11 - 12 - 13 - 14 - 15 - 17 - 19mm
- 3 Slotted (1150 ~ 1170) 5 - 6 - 7mm
- 3 Phillips (1101 ~ 1103) #1 - 2 - 3
- 3 Posidriv (1211 ~ 1213) #1 - 2 - 3
- 6 Hex (2133 ~ 2138) 3 - 4 - 5 - 6 - 7 - 8mm
- 9 Tamperproof Star (7110 ~ 7140)
T10 - 15 - 20 - 25 - 30 - 40 - 45 - 50 - 55
- 1 Adapter 3/8" F x 1/2" M (320040)
- 1 Universal Joint (380070)
- 1 1/4" Hex Shank Bit Holder (383908)
- 2 Spark Plug Socket 16 - 20.6mm
(326016 ~ 326021)
- 2 Ext. 75 - 200mmL (320075 ~ 320200)
- 1 1/4" Hex Shank Screwdriver Handle (280150)
- 1 Ratchet (380333R)



3400g 4 Sets / 14.5 Kgs / 1.07 CUFT

**also available in 6 point sockets (AC-359A)*

GS-320S 20pcs SAE Hand Socket Set 6 pt.

- 13 3/8" Dr. Socket (383208 ~ 383228)
1/4 - 5/16 - 3/8 - 7/16 - 1/2 - 9/16 - 19/32 - 5/8 - 11/16 - 3/4 - 25/32 - 13/16 - 7/8"
- 2 Spark Plug Socket 5/8 - 13/16"
(326016 ~ 326021)
- 2 Ext. 3 - 8"L (320075 ~ 320200)
- 1 Sliding T-Handle (380030)
- 1 Hinge Handle (380336A)
- 1 Ratchet (380333R)



3000g 6 Sets / 19 Kgs / 0.7 CUFT

GS-332MS 32pcs Metric & SAE Hand Socket Set 6 pt.

- 15 3/8" Dr. Socket (323206 ~ 323221)
6 - 7 - 8 - 9 - 10 - 11 - 12 - 13 - 14 - 15 - 16 - 17 - 18 - 19 - 21mm
- 11 3/8" Dr. Socket (383208 ~ 383228)
1/4 - 5/16 - 3/8 - 7/16 - 1/2 - 9/16 - 5/8 - 11/16 - 3/4 - 13/16 - 7/8"
- 1 Universal Joint (380070)
- 2 Ext. 3 - 6"L (320075 ~ 320150)
- 1 Sliding T-Handle (380030)
- 1 Hinge Handle (380336A)
- 1 Ratchet (380333R)



3450g 6 Sets / 22 Kgs / 0.7 CUFT

1/4 & 3/8" Dr. Socket Sets

GS-2343MS 43pcs 1/4" & 3/8" Dr. Metric & SAE Hand Socket Set

- 10 1/4" Dr. Socket (222504 ~ 222512)
4 - 4.5 - 5 - 6 - 7 - 8 - 9 - 10 - 11 - 12mm
- 10 1/4" Dr. Socket (282504 ~ 282516)
1/8 - 3/16 - 7/32 - 1/4 - 9/32 - 5/16 - 11/32 - 3/8 - 7/16 - 1/2"
- 9 3/8" Dr. Socket (323209 ~ 323219)
9 - 10 - 11 - 12 - 13 - 14 - 16 - 17 - 19mm
- 7 3/8" Dr. Socket (383212 ~ 383224)
3/8 - 7/16 - 1/2 - 9/16 - 5/8 - 11/16 - 3/4"
- 1 3/8" Dr. Adapter 3/8" F x 1/4" M (320020)
- 2 3/8" Dr. Spark Plug (326021) 13/16"
- 2 3/8" Dr. Ext. 3 - 8" L (320075 ~ 320200)
- 1 3/8" Dr. Sliding T-Handle (380030)
- 1 1/4" Dr. Socket Driver (220150)
- 1 3/8" Dr. Ratchet (380333R)

3000g 6 Sets / 19 Kgs / 0.7 CUFT



GS-2353M 53pcs 1/4" & 3/8" Dr. Deep Metric Hand Socket Set

- 13 1/4" Dr. Socket (222504 ~ 222514)
4 - 4.5 - 5 - 5.5 - 6 - 7 - 8 - 9 - 10 - 11 - 12 - 13 - 14mm
- 14 3/8" Dr. Socket (323206 ~ 323219)
6 - 7 - 8 - 9 - 10 - 11 - 12 - 13 - 14 - 15 - 16 - 17 - 18 - 19mm
- 10 1/4" Dr. Deep Socket (225205 ~ 225214)
5 - 6 - 7 - 8 - 9 - 10 - 11 - 12 - 13 - 14mm
- 10 3/8" Dr. Deep Socket (326310 ~ 326319)
10 - 11 - 12 - 13 - 14 - 15 - 16 - 17 - 18 - 19mm
- 4 1/4" Dr. Ext. 50, 150mm L (220002, 220006)
3/8" Dr. Ext. 75, 150mm L (320075, 320150)
- 2 1/4" & 3/8" Dr. Ratchet (280272, 380372)

3400g 5 Sets / 18 Kgs / 1.01 CUFT



TX-2319 19pcs 1/4" & 3/8" Dr. Star Hand Socket Set

- 7 1/4" Dr. Star Socket (252504 ~ 252511)
E4 - 5 - 6 - 7 - 8 - 10 - 11
- 7 3/8" Dr. Star Socket (353510 ~ 353520)
E10 - 11 - 12 - 14 - 16 - 18 - 20
- 1 3/8" Dr. Adapter 3/8" F x 1/4" M (320020)
- 2 3/8" Dr. Ext. 3 - 6" L (320075 ~ 320150)
- 1 1/4" Dr. Folding Socket Driver (220160)
- 1 3/8" Dr. Ratchet (380333R)

1600g 10 Sets / 17 Kgs / 0.77 CUFT



TX-2315 15pcs 1/4" & 3/8" Dr. Star Hand Socket Set

- 7 1/4" Dr. Star Socket (252504 ~ 252511)
E4 - 5 - 6 - 7 - 8 - 10 - 11
- 7 3/8" Dr. Star Socket (353510 ~ 353520)
E10 - 11 - 12 - 14 - 16 - 18 - 20
- 1 3/8" Dr. Adapter 3/8" F x 1/4" M (320020)

470g 40 Sets / 20 Kgs / 1.94 CUFT



TX-2356 56pcs Complete Star Type Set

- 5 1/4" Dr. Star Socket (252504 ~ 252508)
E4 - 5 - 6 - 7 - 8
- 7 3/8" Dr. Star Socket (353510 ~ 353520)
E10 - 11 - 12 - 14 - 16 - 18 - 20
- 3 3/8" Dr. Tamperproof Star Bit Socket (310+7145 ~ 340+7155) T45 - 50 - 55
- 10 Tamperproof Star (7107 ~ 7140)
T7 - 8 - 9 - 10 - 15 - 20 - 25 - 27 - 30 - 40
- 16 Star Key Wrench (580506 ~ 581470)
T6 - 7 - 8 - 9 - 10 - 15 - 20 - 25 - 27 - 30 - 40 - 45 - 50 - 55 - 60 - 70
- 13 Star Screwdriver (592+6606 ~ 595+6850)
T6 - 7 - 8 - 9 - 10 - 15 - 20 - 25 - 27 - 30 - 40 - 45 - 50
- 1 1/4" Dr. Hex Shank Bit Holder (283508)
- 1 1/4" & 3/8" Double Drive Ratchet (380371)

3650g 4 Sets / 15.5 Kgs / 1.65 CUFT



1/2" Dr. Hand Sockets

Metric Hand Sockets			Metric Deep Hand Sockets		
ITEM NO.	Size mm	Length mm	ITEM NO.	Size mm	Length mm
423808	8	38	427808	8	78
423809	9	38	427809	9	78
423810	10	38	427810	10	78
423811	11	38	427811	11	78
423812	12	38	427812	12	78
423813	13	38	427813	13	78
423814	14	38	427814	14	78
423815	15	38	427815	15	78
423816	16	38	427816	16	78
423817	17	38	427817	17	78
423818	18	38	427818	18	78
423819	19	40	427819	19	78
423820	20	40	427820	20	78
423821	21	40	427821	21	78
423822	22	42	427822	22	78
423823	23	42	427823	23	78
423824	24	44	427824	24	78
423825	25	44	427825	25	78
423826	26	44	427826	26	78
423827	27	46	427827	27	78
423828	28	46	427828	28	78
423829	29	46	427829	29	78
423830	30	46	427830	30	78
423831	31	46	427831	31	78
423832	32	46	427832	32	78
423833	33	46	427833	33	78
423834	34	46	427834	34	78
423835	35	48	427835	35	78
423836	36	48	427836	36	78
423837	37	48	427837	37	78
423838	38	48	427838	38	78
423839	39	50	427839	39	78
423840	40	55	427840	40	78
423841	41	55	427841	41	78

SAE Hand Sockets			SAE Deep Hand Sockets		
ITEM NO.	Size Inch	Length mm	ITEM NO.	Size Inch	Length mm
483810	5/16	38	487810	5/16	78
483812	3/8	38	487812	3/8	78
483814	7/16	38	487814	7/16	78
483816	1/2	38	487816	1/2	78
483818	9/16	38	487818	9/16	78
483819	19/32	38	487819	19/32	78
483820	5/8	38	487820	5/8	78
483821	21/32	38	487822	11/16	78
483822	11/16	38	487824	3/4	78
483824	3/4	40	487825	25/32	78
483825	25/32	40	487826	13/16	78
483826	13/16	40	487828	7/8	78
483828	7/8	42	487830	15/16	78
483830	15/16	44	487832	1	78
483832	1	44	487834	1-1/16	78
483834	1-1/16	46	487836	1-1/8	78
483836	1-1/8	46	487838	1-3/16	78
483838	1-3/16	46	487840	1-1/4	78
483840	1-1/4	46	487842	1-5/16	78
483842	1-5/16	46	487844	1-3/8	78
483844	1-3/8	48	487846	1-7/16	78
483846	1-7/16	48	487848	1-1/2	78
483848	1-1/2	48	487850	1-9/16	78
483850	1-9/16	55	487852	1-5/8	78
483852	1-5/8	55			

Hand Sockets

1/2" Dr. Hand Sockets

12 pt. Metric Hand Sockets



ITEM NO.	Size mm	Length mm
433808	8	38
433809	9	38
433810	10	38
433811	11	38
433812	12	38
433813	13	38
433814	14	38
433815	15	38
433816	16	38
433817	17	38
433818	18	38
433819	19	40
433820	20	40
433821	21	40
433822	22	42
433823	23	42
433824	24	44
433825	25	44
433826	26	44
433827	27	46
433828	28	46
433829	29	46
433830	30	46
433831	31	46
433832	32	46

12 pt. Metric Deep Hand Sockets



ITEM NO.	Size mm	Length mm
437808	8	78
437809	9	78
437810	10	78
437811	11	78
437812	12	78
437813	13	78
437814	14	78
437815	15	78
437816	16	78
437817	17	78
437818	18	78
437819	19	78
437820	20	78
437821	21	78
437822	22	78
437823	23	78
437824	24	78
437825	25	78
437826	26	78
437827	27	78
437828	28	78
437829	29	78
437830	30	78
437831	31	78
437832	32	78

12 pt. SAE Hand Sockets

ITEM NO.	Size Inch	Length mm
473810	5/16	38
473812	3/8	38
473814	7/16	38
473816	1/2	38
473818	9/16	38
473819	19/32	38
473820	5/8	38
473821	21/32	38
473822	11/16	38
473824	3/4	40
473825	25/32	40
473826	13/16	40
473828	7/8	42
473830	15/16	44
473832	1	44
473834	1-1/16	46
473836	1-1/8	46
473838	1-3/16	46
473840	1-1/4	46

12 pt. SAE Deep Hand Sockets

ITEM NO.	Size Inch	Length mm
477810	5/16	78
477812	3/8	78
477814	7/16	78
477816	1/2	78
477818	9/16	78
477819	19/32	78
477820	5/8	78
477822	11/16	78
477824	3/4	78
477825	25/32	78
477826	13/16	78
477828	7/8	78
477830	15/16	78
477832	1	78
477834	1-1/16	78
477836	1-1/8	78
477838	1-3/16	78
477840	1-1/4	78

E-Star Hand Sockets



ITEM NO.	Size	Length mm
454510	E-10	38
454511	E-11	38
454512	E-12	38
454514	E-14	38
454516	E-16	38
454518	E-18	40
454520	E-20	40
454522	E-22	40
454524	E-24	40

6 pt. Spark Plug Sockets



ITEM NO.	Size mm (inch)	Length mm
427016	16.0 (5/8")	70
427021	20.6 (13/16")	70

6 pt. Swivel Spark Plug Sockets



ITEM NO.	Size mm (inch)	Length mm
418516	16.0 (5/8")	95
418521	20.6 (13/16")	95

A 72 Teeth Ratchet



ITEM NO.	Length mm
480472S	285

B 72 Teeth Ratchet



ITEM NO.	Length mm
480472P	275

1/2" Dr. Accessories

C 72 Teeth Ratchet



ITEM NO.	Length mm
480472	245

D 36 Teeth Ratchet w/ Quick Release



ITEM NO.	Length mm
480431S	285

E 36 Teeth Ratchet w/ Quick Release



ITEM NO.	Length mm
480431P	275

F 36 Teeth Ratchet w/ Quick Release



ITEM NO.	Length mm
480431R	255

G 72 Teeth Rotor Ratchet



ITEM NO.	Length mm
481804S	330

H 72 Teeth Rotor Ratchet



ITEM NO.	Length mm
481804P	320

I 72 Teeth Rotor Ratchet



ITEM NO.	Length mm
481804	280

J 72 Teeth Flex Head Ratchets



ITEM NO.	Length mm
484464S	430
484468S	650

K 72 Teeth Flex Head Ratchets



ITEM NO.	Length mm
484464P	430
484468P	650

L 72 Teeth Flex Head Ratchet



ITEM NO.	Length mm
484464	400

M Hinge Handles



ITEM NO.	Length mm
480446S	430
480448S	630

N Hinge Handles



ITEM NO.	Length mm
480446P	410
480448P	620

O Hinge Handle



ITEM NO.	Length mm
480446A	380

P Hinge Handle



ITEM NO.	Length mm
480446	380

Q 24Teeth Reversible Ratchet



ITEM NO.	Length mm
480444R	250

R Sliding T-Handle



ITEM NO.	Length mm
480040	320

S L-Handle



ITEM NO.	Length mm
420260L	260

T Speed Handles



ITEM NO.	Length mm
480420	420
480490	490

U T-Handles (Spark Plug Socket)



ITEM NO.	Size	Length mm
4238016T	5/8" (16mm)	380
4238021T	13/16" (20.6mm)	380
4253016T	5/8" (16mm)	530
4253021T	13/16" (20.6mm)	530

V T-Handles (Quick Release)

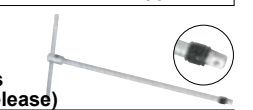

ITEM NO.	Length mm
425004	500
427004	700

W T-Handles (Ball Joint)

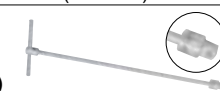

ITEM NO.	Length mm
423504T	350
425004T	500

X T-Handles (Universal Joint)



ITEM NO.	Length mm
425004U	500
427004U	700

1/2" Dr. Accessories

Y Bit Holders

ITEM NO.	Hex Shank	Length mm
484108	1/4"	41
484808	1/4"	48
484110	5/16"	41
484810	5/16"	48

Z Adapters

ITEM NO.	Female Drive	Male Drive	Length mm
420033	1/2"	3/8"	38
420066	1/2"	3/4"	41

a Universal Joint

ITEM NO.	Length mm
480070	78

c Extension Bars

ITEM NO.	Length mm (Inch)
424050	50 (2")
424075	75 (3")
424125	125 (5")
424320	250 (10")

b Wobble Extension Bars

ITEM NO.	Length mm (Inch)
420002B	50 (2")
420003B	75 (3")
420005B	125 (5")
420008B	200 (8")
420010B	250 (10")
420015B	375 (15")
420024B	600 (24")

1/2" Dr. Hand Socket Sets

GS-412M 12pcs Metric Hand Socket Set

12 1/2" Dr. Socket (423808 ~ 423819)
8 - 9 - 10 - 11 - 12 - 13 - 14 - 15 -
16 - 17 - 18 - 19mm

950g 20 Sets / 20 Kgs / 1.24 CUFT

TW-415M 15pcs Metric Hand Socket Set

15 1/2" Dr. Socket (433810 ~ 433830)
10 - 11 - 12 - 13 - 14 - 15 -
16 - 17 - 18 - 19 - 21 - 22 -
24 - 27 - 30mm

1700g 10 Sets / 18 Kgs / 0.45 CUFT

SS-425M 25pcs Metric Hand Socket Set

25 1/2" Dr. Socket (423808 ~ 423836)
8 - 9 - 10 - 11 - 12 - 13 - 14 -
15 - 16 - 17 - 18 - 19 - 20 - 21 -
22 - 23 - 24 - 25 - 26 - 27 - 28 -
29 - 30 - 32 - 36mm

3500g 3 Sets / 12 Kgs / 0.82 CUFT

GD-412M 12pcs Metric Deep Hand Socket Set

12 1/2" Dr. Deep Socket (427808 ~ 427819)
8 - 9 - 10 - 11 - 12 - 13 - 14 -
15 - 16 - 17 - 18 - 19mm

1920g 12 Sets / 24 Kgs / 1.16 CUFT

DS-425M 25pcs Metric Deep Hand Socket Set

25 1/2" Dr. Deep Socket (427808 ~ -36)
8 - 9 - 10 - 11 - 12 - 13 - 14 -
15 - 16 - 17 - 18 - 19 - 20 - 21 -
22 - 23 - 24 - 25 - 26 - 27 - 28 -
29 - 30 - 32 - 36mm

7000g 3 Sets / 22 Kgs / 0.82 CUFT

DS-440M 40pcs Metric Deep Hand Socket Set

19 1/2" Dr. Socket (423809 ~ 423830)
9 - 10 - 11 - 12 - 13 - 14 - 15 - 16 - 17 - 18 -
19 - 20 - 21 - 22 - 23 - 24 - 26 - 27 - 30mm
19 1/2" Dr. Deep Socket (427809 ~ 427830)
9 - 10 - 11 - 12 - 13 - 14 - 15 - 16 - 17 - 18 -
19 - 20 - 21 - 22 - 23 - 24 - 26 - 27 - 30mm
1 Universal Joint (480070)
1 Ext. 125mmL (424125)

7000g 3 Sets / 22 Kgs / 1.16 CUFT

1/2" Dr. Hand Socket Sets

GS-412S 12pcs SAE Hand Socket Set

12 1/2" Dr. Socket (483810 ~ 483832)
5/16 - 3/8 - 7/16 - 1/2 - 9/16 - 5/8 - 11/16 -
3/4 - 13/16 - 7/8 - 15/16 - 1"

1200g 20 Sets / 25 Kgs / 1.24 CUFT

TW-414S 14pcs SAE Hand Socket Set

14 1/2" Dr. Socket (473812 ~ 473840)
3/8 - 7/16 - 1/2 - 9/16 - 5/8 - 11/16 - 3/4 - 13/16 - 7/8 - 15/16 -
1" - 1 1/16 - 1 1/8 - 1 1/4"

1900g 10 Sets / 20 Kgs / 0.45 CUFT

SS-422S 22pcs SAE Hand Socket Set

22 1/2" Dr. Socket (483810 ~ 483848)
5/16 - 3/8 - 7/16 - 1/2 - 9/16 -
19/32 - 5/8 - 11/16 - 3/4 - 25/32 -
13/16 - 7/8 - 15/16 - 1" - 1 1/16 -
1 1/8 - 1 3/16 - 1 1/4 - 1 5/16 -
1 3/8 - 1 7/16 - 1 1/2"

4000g 3 Sets / 13 Kgs / 0.82 CUFT

GD-412S 12pcs SAE Deep Hand Socket Set

12 1/2" Dr. Deep Socket (487810 ~ 487832)
5/16 - 3/8 - 7/16 - 1/2 - 9/16 -
5/8 - 11/16 - 3/4 - 13/16 - 7/8 -
15/16 - 1"

2230g 12 Sets / 28 Kgs / 1.16 CUFT

DS-422S 22pcs SAE Deep Hand Socket Set

22 1/2" Dr. Deep Socket (487810 ~ 487848)
5/16 - 3/8 - 7/16 - 1/2 - 9/16 -
19/32 - 5/8 - 11/16 - 3/4 - 25/32 -
13/16 - 7/8 - 15/16 - 1" - 1 1/16 -
1 1/8 - 1 3/16 - 1 1/4 - 1 5/16 -
1 3/8 - 1 7/16 - 1 1/2"

6700g 3 Sets / 21 Kgs / 0.82 CUFT

DS-434S 34pcs SAE Deep Hand Socket Set

16 1/2" Dr. Socket (483810 ~ 483840)
5/16 - 3/8 - 7/16 - 1/2 - 9/16 - 5/8 -
11/16 - 3/4 - 13/16 - 7/8 - 15/16 - 1" -
1 1/16 - 1 1/8 - 1 3/16 - 1 1/4"
16 1/2" Dr. Deep Socket (487810 ~ 487840)
5/16 - 3/8 - 7/16 - 1/2 - 9/16 - 5/8 -
11/16 - 3/4 - 13/16 - 7/8 - 15/16 - 1" -
1 1/16 - 1 1/8 - 1 3/16 - 1 1/4"
1 Universal Joint (480070)
1 Ext. 5"L (424125)

7000g 3 Sets / 22 Kgs / 1.16 CUFT

TX-409 9pcs Star Hand Socket Set

9 1/2" Dr. Star Socket (454510 ~ 454524)
E10 - 11 - 12 - 14 - 16 - 18 -
20 - 22 - 24

800g 20 Sets / 17 Kgs / 0.64 CUFT

TX-23414 14pcs 1/4, 3/8 & 1/2" Dr. Star Hand Socket Set

5 1/4" Dr. Star Socket (252504 ~ -08)
E4 - 5 - 6 - 7 - 8
5 3/8" Dr. Star Socket (353510 ~ -16)
E10 - 11 - 12 - 14 - 16
4 1/2" Dr. Star Socket
(454518 ~ -24)
E18 - 20 - 22 - 24

720g 40 Sets / 30 Kgs / 1.94 CUFT

Hand Sockets

1/2" Dr. Socket Sets w/ Rubber Handle Ratchet

EU-426M 26pcs Metric Hand Socket Set 6 pt.

21 1/2" Dr. Socket (423810 ~ 423834)
 10 - 11 - 12 - 13 - 14 - 15 - 16 - 17 -
 18 - 19 - 20 - 21 - 22 - 23 - 24 - 26 -
 27 - 28 - 30 - 32 - 34mm

1 Universal Joint (480070)
 2 Ext. 125 - 250mmL (424125 ~ -320)
 1 Sliding T-Handle (480040)
 1 Quick Release Ratchet (480431S)

5200g 4 Sets / 22 Kgs / 1.07 CUFT



EU-421S 21pcs SAE Hand Socket Set 12 pt.

16 1/2" Dr. Socket (473812 ~ 473840)
 3/8 - 7/16 - 1/2 - 9/16 - 19/32 - 5/8 -
 11/16 - 3/4 - 13/16 - 7/8 - 15/16 - 1" -
 1 1/16 - 1 1/8 - 1 3/16 - 1 1/4"

1 Universal Joint (480070)
 2 Ext. 5 - 10"L (424125 ~ -320)
 1 Sliding T-Handle (480040)
 1 Quick Release Ratchet (480431S)

4450g 4 Sets / 19 Kgs / 1.07 CUFT



1/2" Dr. Socket Sets w/ Plastic Handle Ratchet

EU-422M 22pcs Metric Hand Socket Set 6 pt.

18 1/2" Dr. Socket (423808 ~ 423832)
 8 - 10 - 11 - 12 - 13 - 14 - 15 - 16 -
 17 - 18 - 19 - 21 - 22 - 23 - 24 - 27 -
 30 - 32mm

1 Universal Joint (480070)
 2 Ext. 125 - 250mmL (424125 ~ -320)
 1 72 Teeth Ratchet (480472P)

3650g 4 Sets / 15.5 Kgs / 0.85 CUFT



1/2" Dr. Socket Sets w/ Chrome Handle Ratchet

Deep TW-439M 39pcs Metric Deep Hand Socket Set 12 pt.

20 1/2" Dr. Socket (433809 ~ 433832)
 9 - 10 - 11 - 12 - 13 - 14 - 15 - 16 -
 17 - 18 - 19 - 20 - 21 - 22 - 23 - 24 -
 26 - 27 - 30 - 32mm

14 1/2" Dr. Deep Socket (437809 ~ 437822)
 9 - 10 - 11 - 12 - 13 - 14 - 15 - 16 -
 17 - 18 - 19 - 20 - 21 - 22mm

1 Two Way Adapter 3/8"F x 1/2"M (320042)
 1 Universal Joint (480070)
 2 Ext. 125 - 250mmL (424125 ~ 424323)
 1 Quick Release Ratchet (480431R)

7500g 3 Sets / 23.5 Kgs / 1.16 CUFT



Deep TW-432S 32pcs SAE Deep Hand Socket Set 12 pt.

16 1/2" Dr. Socket (473812 ~ 473840)
 3/8 - 7/16 - 1/2 - 9/16 - 19/32 - 5/8 -
 11/16 - 3/4 - 25/32 - 13/16 - 7/8 -
 15/16 - 1" - 1 1/16 - 1 1/8 - 1 1/4"

11 1/2" Dr. Deep Socket (477812 ~ 477828)
 3/8 - 7/16 - 1/2 - 9/16 - 19/32 - 5/8 -
 11/16 - 3/4 - 25/32 - 13/16 - 7/8"

1 Two Way Adapter 3/8"F x 1/2"M (320042)
 1 Universal Joint (480070)
 2 Ext. 5 - 10"L (424125 ~ 424323)
 1 Quick Release Ratchet (480431R)

7000g 3 Sets / 22 Kgs / 1.16 CUFT

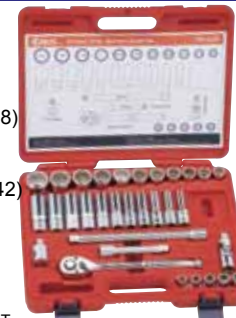

1/2" Dr. Socket Sets w/ Knurled Handle Ratchet

GS-416M* 16pcs Metric Hand Socket Set 6 pt.

13 1/2" Dr. Socket (423808 ~ 423827)
 8 - 10 - 11 - 12 - 13 - 14 - 16 - 17 -
 19 - 21 - 22 - 24 - 27mm

1 Ext. 125mmL (424125)
 1 Hinge Handle (480446A)
 1 Ratchet (480444R)

3750g 4 Sets / 16 Kgs / 0.93 CUFT

**also available in 12 point sockets (TW-416M)*



GS-424M* 24pcs Metric Hand Socket Set 6 pt.

18 1/2" Dr. Socket (423808 ~ 423832)
 8 - 9 - 10 - 11 - 12 - 13 - 14 - 15 - 16 -
 17 - 18 - 19 - 21 - 22 - 24 - 27 - 30 - 32mm

1 Universal Joint (480070)
 1 Spark Plug Socket 20.6mm (427021)
 2 Ext. 125 - 250mmL (424125 ~ 424320)
 1 Sliding T-Handle (480040)
 1 Ratchet (480444R)

5000g 4 Sets / 21 Kgs / 1.07 CUFT

**also available in 12 point sockets (TW-424M)*



GS-427M 27pcs Metric Hand Socket Set 6 pt.

19 1/2" Dr. Socket (423810 ~ 423832)
 10 - 11 - 12 - 13 - 14 - 15 - 16 - 17 - 18 - 19 - 21 - 22 - 23 - 24 -
 26 - 27 - 28 - 30 - 32mm

1 Universal Joint (480070)
 1 Spark Plug Socket 20.6mm (427021)
 2 Ext. 125 - 250mm (424125 ~ 424320)
 1 Pin Handle 250mmL (480446PP)
 1 Sliding T-Handle (480040)
 1 Hinge Handle (480446A)
 1 Ratchet (480444R)

6750g 4 Sets / 28 Kgs / 0.88 CUFT



GS-416S* 16pcs SAE Hand Socket Set 6 pt.

13 1/2" Dr. Socket (483810 ~ 483834)
 5/16 - 3/8 - 7/16 - 1/2 - 9/16 - 5/8 -
 11/16 - 3/4 - 13/16 - 7/8 - 15/16 -
 1" - 1 1/16"

1 Ext. 5"L (424125)
 1 Hinge Handle (480446A)
 1 Ratchet (480444R)

3750g 4 Sets / 16 Kgs / 0.93 CUFT

**also available in 12 point sockets (TW-416S)*



GS-424S* 24pcs SAE Hand Socket Set 6 pt.

18 1/2" Dr. Socket (483810 ~ 483840)
 5/16 - 3/8 - 7/16 - 1/2 - 9/16 - 19/32 -
 5/8 - 11/16 - 3/4 - 25/32 - 13/16 - 7/8 -
 15/16 - 1" - 1 1/16 - 1 1/8 - 1 3/16 - 1 1/4"

1 Universal Joint (480070)
 1 Spark Plug Socket 13/16" (427021)
 2 Ext. 5 - 10"L (424125 ~ 424320)
 1 Sliding T-Handle (480040)
 1 Ratchet (480444R)

5000g 4 Sets / 21 Kgs / 1.07 CUFT

**also available in 12 point sockets (TW-424S)*



GS-427S 27pcs SAE Hand Socket Set 6 pt.

19 1/2" Dr. Socket (483810 ~ 483840)
 5/16 - 3/8 - 7/16 - 1/2 - 9/16 - 19/32 - 5/8 - 21/32 - 11/16 - 3/4 -
 25/32 - 13/16 - 7/8 - 15/16 - 1" -
 1 1/16 - 1 1/8 - 1 3/16 - 1 1/4"

1 Universal Joint (480070)
 1 Spark Plug Socket 13/16" (427021)
 2 Ext. 5 - 10"L (424125 ~ 424320)
 1 Pin Handle 10"L (480446PP)
 1 Sliding T-Handle (480040)
 1 Hinge Handle (480446A)
 1 Ratchet (480444R)

6750g 4 Sets / 28 Kgs / 0.88 CUFT

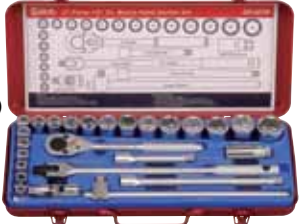

GS-446MS* 46pcs Metric & SAE Hand Socket Set

23 1/2" Dr. Socket (423808 ~ 423832) 6 pt.
8 - 9 - 10 - 11 - 12 - 13 - 14 - 15 - 16 - 17 - 18 - 19 - 20 - 21 - 22 - 23 - 24 - 25 - 26 - 27 - 28 - 30 - 32mm

14 1/2" Dr. Socket (483812 ~ 483840)
3/8 - 7/16 - 1/2 - 9/16 - 5/8 - 11/16 - 3/4 - 13/16 - 7/8 - 15/16 - 1" - 1 1/8" - 1 3/16 - 1 1/4"

1 Universal Joint (480070)
2 Spark Plug Socket 5/8 - 13/16" (427016 ~ 427021)

2 Ext. 5 - 10"L (424125 ~ 424320)
1 Pin Handle 10"L (480446PP)
1 Sliding T-Handle (480040)
1 Hinge Handle (480446A)
1 Ratchet (480444R)



9800g 2 Sets / 21 Kgs / 0.73 CUFT

XV-424M 24pcs Metric Hand Socket Set

18 1/2" Dr. Socket (V4208 ~ V4232) 6 pt.
8 - 9 - 10 - 11 - 12 - 13 - 14 - 15 - 16 - 17 - 18 - 19 - 21 - 22 - 24 - 27 - 30 - 32mm

1 Universal Joint (V4UJ4)
1 Spark Plug Socket 20.6mm (V4S21)
2 Ext. 125 - 250mmL (V4E05 ~ V4E10)
1 Sliding T-Handle (V4S12)
1 Quick Release Ratchet (V4R10)



4000g 4 Sets / 17 Kgs / 1.07 CUFT

AC-2487A 1/4" & 1/2" Dr. 87pcs Metric Master Hand Socket & Bit Set

14 1/4" Dr. Socket (222503 ~ 222514) 6 pt.
3 - 4 - 4.5 - 5 - 5.5 - 6 - 7 - 8 - 9 - 10 - 11 - 12 - 13 - 14mm

8 1/4" Dr. Deep Socket (225206 ~ 225213)
6 - 7 - 8 - 9 - 10 - 11 - 12 - 13mm

15 1/2" Dr. Socket (423810 ~ 423832)
10 - 12 - 13 - 14 - 15 - 16 - 17 - 18 - 19 - 21 - 22 - 24 - 27 - 30 - 32mm

4 1/2" Dr. Deep Socket (427810 ~ 427819)
10 - 13 - 17 - 19mm

6 Slotted 4.0 - 5.5 - 6.5 - 9.0 - 10 - 12mm
4 Phillips #1 - 2 - 3 - 4
4 Posidriv #1 - 2 - 3 - 4
8 Hex 3 - 4 - 5 - 6 - 8 - 10 - 12 - 14mm
10 Star T8 - 10 - 15 - 20 - 25 - 30 - 40 - 45 - 50 - 55

2 Universal Joint 1/4"Dr.(280070) & 1/2"Dr.(480070)
2 Bit Holder 1/4"Dr. 1/4" Shank(282408) & 1/2"Dr. 5/16" Shank(484810)
2 Spark Plug 1/2"Dr. (427016 ~ 427021) 16mm(5/8") - 20.6mm(13/16")

4 Ext. 1/4"Dr. 50 - 100mmL & 1/2"Dr. 125 - 250mmL
1 Sliding T-Handle 1/4"Dr.(280020)
1 Socket Driver 1/4"Dr. (506+0175)
2 Quick Release Ratchet 1/4"Dr.(280231S) & 1/2"Dr.(480431S)



6000g 4 Sets / 25 Kgs / 1.65 CUFT

AC-2487 1/4" & 1/2" Dr. 87pcs Metric Master Hand Socket & Bit Set

14 1/4" Dr. Socket (222503 ~ 222514) 6 pt. 12 pt.
3 - 4 - 4.5 - 5 - 5.5 - 6 - 7 - 8 - 9 - 10 - 11 - 12 - 13 - 14mm

8 1/4" Dr. Deep Socket (225206 ~ 225213)
6 - 7 - 8 - 9 - 10 - 11 - 12 - 13mm

15 1/2" Dr. Socket (433810 ~ 433832)
10 - 13 - 15 - 16 - 17 - 18 - 19 - 20 - 21 - 22 - 23 - 24 - 27 - 30 - 32mm

4 1/2" Dr. Deep Socket (437814 ~ 437819)
14 - 16 - 17 - 19mm

6 Slotted 4.0 - 5.5 - 6.5 - 8.0 - 10 - 12mm
4 Phillips #1 - 2 - 3 - 4
4 Posidriv #1 - 2 - 3 - 4
8 Hex 3 - 4 - 5 - 6 - 8 - 10 - 12 - 14mm
6 Tamperproof Star T8 - 10 - 15 - 20 - 25 - 30
4 Star T40 - 45 - 50 - 55

2 Universal Joint 1/4"Dr.(280070) & 1/2"Dr.(480070)
2 Bit Holder 1/4"Dr. 1/4" Shank(282408) & 1/2"Dr. 5/16" Shank(484810)
2 Spark Plug 1/2"Dr. (427016 ~ 427021) 16mm(5/8") - 20.6mm(13/16")

4 Ext. 1/4"Dr. 50 - 100mmL & 1/2"Dr. 125 - 250mmL
1 Sliding T-Handle 1/4"Dr.(280020)
1 Socket Driver 1/4"Dr. (220150)
2 Ratchet 1/4"Dr.(280222R) & 1/2"Dr.(480444R)



6120g 4 Sets / 25.5 Kgs / 1.65 CUFT

AC-234125 1/4", 3/8" & 1/2" Dr. 125pcs Metric Tool Set

12 1/4" Dr. Socket : 4 - 4.5 - 5 - 5.5 - 6 - 7 - 8 - 9 - 10 - 11 - 12 - 13mm 6 pt.

14 3/8" Dr. Socket : 6 - 7 - 8 - 9 - 10 - 11 - 12 - 13 - 14 - 15 - 16 - 17 - 18 - 19mm

17 1/2" Dr. Socket : 11 - 12 - 13 - 14 - 15 - 16 - 17 - 18 - 19 - 20 - 21 - 22 - 23 - 24 - 25 - 26 - 27mm

8 Slotted 3 - 4 - 5 - 6mm
7 Phillips #0 - 1 - 2 - 3
4 Posidriv #0 - 1 - 2 - 3
6 Hex 3 - 4 - 5 - 6 - 7 - 8mm
7 Star T10 - 15 - 20 - 25 - 27 - 30 - 40

11 Square #1 - 2 - 3
1 3/8" Dr. Adapter x 1/4"M
2 Spark Plug 16mm - 20.6mm
5 Extensions : 50 - 75 - 125 - 150 - 250mmL

1 1/4" Hex Shank Handle
1 1/4" Dr. Folding Socket Driver
2 Ratchet 3/8"Dr.(380372) & 1/2"Dr.(480472)
9 Hex Key Wrench : 1.5 - 2 - 2.5 - 3 - 4 - 5 - 6 - 8 - 10mm
11 Combination : 6 - 7 - 8 - 9 - 10 - 12 - 13 - 15 - 16 - 17 - 19mm
3 Hex Bit Holder - Insert Bit Holder - 1/4" Hex Shank 1/4"Dr. Adapter
3 6" Linesman - 6" Longnose - 6" Diagonal Cutting



7800g 3 Sets / 25.5 Kgs / 2.06 CUFT

AC-23117 1/4" & 3/8" Dr. 117pcs Metric & SAE Tool Set

21 1/4" Dr. Socket : 4 - 4.5 - 5 - 5.5 - 6 - 7 - 8 - 9 - 10 - 11 - 12 - 13mm 6 pt.
3/16 - 7/32 - 1/4 - 9/32 - 5/16 - 11/32 - 3/8 - 7/16 - 1/2"

17 3/8" Dr. Socket : 9 - 10 - 12 - 13 - 14 - 15 - 17 - 18mm
5/16 - 11/32 - 3/8 - 7/16 - 1/2 - 9/16 - 5/8 - 11/16 - 3/4"

7 Star T10 - 15 - 20 - 25 - 27 - 30 - 40
8 Slotted 3 - 4 - 5 - 6mm
7 Phillips #0 - 1 - 2 - 3
4 Posidriv #0 - 1 - 2 - 3
6 Hex 3 - 4 - 5 - 6 - 7 - 8mm
11 Square #1 - 2 - 3
1 3/8" Dr. Adapter x 1/4"M
3 Ext. 2 - 3 - 6"L
1 1/4" Hex Shank Handle
1 1/4" Dr. Folding Driver
1 3/8" Dr. Ratchet (380372)
9 Hex Key : 1.5 ~ 10mm
13 Combination : 10 - 12 - 13 - 15 - 17 - 18mm & SAE : 3/8 - 7/16 - 1/2 - 9/16 - 5/8 - 11/16 - 3/4"

3 Hex Bit Holder - Insert Bit Holder - 1/4" Hex Shank 1/4"Dr. Adapter
3 6" Linesman - 6" Longnose - 6" Diagonal Cutting

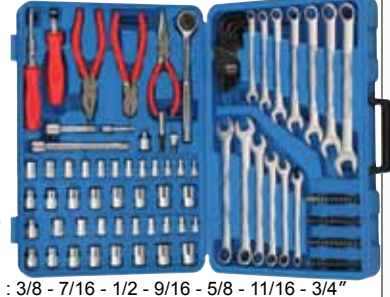

5600g 3 Sets / 18 Kgs / 2.06 CUFT

AC-234151 1/4", 3/8" 1/2" Dr. 151pcs Metric & SAE Master Set

25 1/4" Dr. Socket : 4 - 5 - 5.5 - 6 - 7 - 8 - 9 - 10 - 11 - 12mm 6 pt. 12 pt.
1/8 - 3/16 - 7/32 - 1/4 - 9/32 - 5/16 - 11/32"

1/4" Dr. Star : E4 - E5 - E6 - E7 - E8 - E10 & 1/4" Dr. Socket : 8 - 10mm(8pt.)

32 3/8" Dr. Socket : 13 - 14 - 15 - 16 - 17 - 18 - 19mm
3/8 - 7/16 - 1/2 - 9/16 - 5/8 - 11/16 - 3/4 - 13/16 - 7/8"(12pt.)

3/8" Dr. Deep : 8 - 9 - 10 - 12 - 13 - 14 - 15 - 16 - 17 - 18 - 19mm(12pt.)

3/8" Dr. Star : E12 - E14 - E16 - E18 - E20

16 1/2" Dr. Socket : 20 - 21 - 22 - 24 - 27 - 30 - 32mm
15/16 - 1" - 1 1/16 - 1 1/4"(12pt.)

1/2" Dr. Impact Socket : 17 - 18 - 19 - 21 - 22mm

4 Slotted 3 - 4 - 5.5 - 6.5mm
4 Phillips #0 - 1 - 2 - 3
4 Posidriv #0 - 1 - 2 - 3
6 Hex 3 - 4 - 5 - 6 - 7 - 8mm
7 Star T10 - 15 - 20 - 25 - 27 - 30 - 40
11 Tamperproof Star T10 ~ 60
2 Universal Joint : 1/4" - 3/8" - 1/2"Dr.
3 Spark Plug Socket : 5/8 - 13/16"

5 Extension : 2 - 3 - 5 - 6 - 10"L
1 1/4" Hex Shank Screwdriver Handle
1 1/4" Dr. Socket Driver
3 Ratchet : 1/4" - 3/8" - 1/2"Dr.
9 Wobble Hex Key : 1.5 ~ 10mm
12 Combination : 8 - 9 - 10 - 11 - 12 - 13 - 14 - 15 - 16 - 17 - 18 - 19mm

3 Hex Bit Holder - Insert Bit Holder - 1/4"Dr. Adapter
3 6" Linesman - 6" Longnose - 6" Diagonal Cutting



11.8 Kg 2 Sets / 24.5 Kgs / 1.54 CUFT

Hand Sockets

3/4" Dr. Hand Sockets

6 pt. Metric Hand Sockets



6 pt. Metric Deep Hand Sockets



ITEM NO.	Size mm	Length mm
625217	17	51
625218	18	51
625219	19	51
625220	20	51
625221	21	51
625222	22	51
625223	23	51
625224	24	51
625225	25	54
625226	26	54
625227	27	54
625228	28	54
625229	29	54
625230	30	54
625231	31	54
625232	32	57
625233	33	57
625234	34	57
625235	35	57
625236	36	57
625237	37	57
625238	38	57
625239	39	58
625240	40	58
625241	41	58
625242	42	58
625243	43	60
625244	44	63
625245	45	63
625246	46	63
625247	47	63
625248	48	65
625249	49	65
625250	50	68
625251	51	68
625252	52	70
625253	53	70
625254	54	73
625255	55	73
625256	56	73
625257	57	73
625258	58	73
625259	59	73
625260	60	80
625261	61	80
625262	62	80
625263	63	80
625264	64	80
625265	65	85
625266	66	85
625267	67	85
625268	68	85
625269	69	85
625270	70	90
625271	71	90
625272	72	90
625273	73	90
625274	74	90
625275	75	90
625276	76	90

ITEM NO.	Size mm	Length mm
629517	17	90
629518	18	90
629519	19	90
629520	20	90
629521	21	90
629522	22	90
629523	23	90
629524	24	90
629525	25	90
629526	26	90
629527	27	90
629528	28	90
629529	29	90
629530	30	90
629531	31	90
629532	32	90
629533	33	90
629534	34	90
629535	35	90
629536	36	90
629537	37	90
629538	38	90
629539	39	90
629540	40	90
629541	41	90
629542	42	90
629543	43	90
629544	44	90
629545	45	95
629546	46	95
629547	47	95
629548	48	100
629549	49	100
629550	50	100
629551	51	100
629552	52	100
629553	53	100
629554	54	100
629555	55	100
629556	56	100
629557	57	100
629558	58	100
629559	59	100
629560	60	105
629561	61	105
629562	62	105
629563	63	105
629564	64	105
629565	65	105
629566	66	105
629567	67	105
629568	68	105
629569	69	105
629570	70	110
629571	71	110
629572	72	110
629573	73	110
629574	74	110
629575	75	110
629576	76	110

3/4" Dr. Hand Sockets

6 pt. SAE Hand Sockets



6 pt. SAE Deep Hand Sockets



ITEM NO.	Size Inch	Length mm
685222	11/16	51
685224	3/4	51
685225	25/32	51
685226	13/16	51
685228	7/8	51
685230	15/16	51
685232	1	54
685234	1-1/16	54
685236	1-1/8	54
685238	1-3/16	54
685240	1-1/4	57
685242	1-5/16	57
685244	1-3/8	57
685246	1-7/16	57
685248	1-1/2	57
685250	1-9/16	58
685252	1-5/8	58
685254	1-11/16	60
685256	1-3/4	63
685258	1-13/16	63
685260	1-7/8	65
685262	1-15/16	65
685264	2	68
685266	2-1/16	70
685268	2-1/8	73
685270	2-3/16	73
685272	2-1/4	73
685274	2-5/16	73
685276	2-3/8	80
685278	2-7/16	80
685280	2-1/2	80
685282	2-9/16	85
685284	2-5/8	85
685286	2-11/16	85
685288	2-3/4	90
685290	2-13/16	90
685292	2-7/8	90
685294	2-15/16	90
685296	3	90

ITEM NO.	Size Inch	Length mm
689522	11/16	90
689524	3/4	90
689525	25/32	90
689526	13/16	90
689528	7/8	90
689530	15/16	90
689532	1	90
689534	1-1/16	90
689536	1-1/8	90
689538	1-3/16	90
689540	1-1/4	90
689542	1-5/16	90
689544	1-3/8	90
689546	1-7/16	90
689548	1-1/2	90
689550	1-9/16	90
689552	1-5/8	90
689554	1-11/16	90
689556	1-3/4	95
689558	1-13/16	95
689560	1-7/8	100
689562	1-15/16	100
689564	2	100
689566	2-1/16	100
689568	2-1/8	100
689570	2-3/16	100
689572	2-1/4	100
689574	2-5/16	100
689576	2-3/8	105
689578	2-7/16	105
689580	2-1/2	105
689582	2-9/16	105
689584	2-5/8	105
689586	2-11/16	105
689588	2-3/4	110
689590	2-13/16	110
689592	2-7/8	110
689594	2-15/16	110
689596	3	110

3/4" Dr. Accessories

A 36 Teeth Ratchet with Plastic Handle

ITEM NO.	Length mm
680610S	610

B 24 Teeth Ratchet with Metal Handle

ITEM NO.	Length mm
680666R	500

C 24 Teeth Ratchet Head with Tube Handle

ITEM NO.	Length mm
680666RA	500

D 24 Teeth Ratchet Head

ITEM NO.	Length mm
680666	260

E Hinge Handle

ITEM NO.	Length mm
680446A	510

F Hinge Head with Tube Handle

ITEM NO.	Length mm
680446E	560

3/4" Dr. Hand Sockets

12 pt. Metric Hand Sockets



ITEM NO.	Size mm	Length mm
635217	17	51
635218	18	51
635219	19	51
635220	20	51
635221	21	51
635222	22	51
635223	23	51
635224	24	51
635225	25	54
635226	26	54
635227	27	54
635228	28	54
635229	29	54
635230	30	54
635231	31	54
635232	32	57
635233	33	57
635234	34	57
635235	35	57
635236	36	57
635237	37	57
635238	38	57
635239	39	58
635240	40	58
635241	41	58
635242	42	58
635243	43	60
635244	44	63
635245	45	63
635246	46	63
635247	47	63
635248	48	65
635249	49	65
635250	50	68
635251	51	68
635252	52	70
635253	53	70
635254	54	73
635255	55	73
635256	56	73
635257	57	73
635258	58	73
635259	59	73
635260	60	80
635261	61	80
635262	62	80
635263	63	80
635264	64	80
635265	65	85
635266	66	85
635267	67	85
635268	68	85
635269	69	85
635270	70	90

12 pt. SAE Hand Sockets



ITEM NO.	Size Inch	Length mm
675222	11/16	51
675224	3/4	51
675225	25/32	51
675226	13/16	51
675228	7/8	51
675230	15/16	51
675232	1	54
675234	1-1/16	54
675236	1-1/8	54
675238	1-3/16	54
675240	1-1/4	57
675242	1-5/16	57
675244	1-3/8	57
675246	1-7/16	57
675248	1-1/2	57
675250	1-9/16	58
675252	1-5/8	58
675254	1-11/16	60
675256	1-3/4	63
675258	1-13/16	63
675260	1-7/8	65
675262	1-15/16	65
675264	2	68
675266	2-1/16	70
675268	2-1/8	73
675270	2-3/16	73
675272	2-1/4	73
675274	2-5/16	73
675276	2-3/8	80
675278	2-7/16	80
675280	2-1/2	80
675282	2-9/16	85
675284	2-5/8	85
675286	2-11/16	85
675288	2-3/4	90

3/4" Dr. Accessories

G Hinge Head



ITEM NO.	Length mm
680446	320

H Tube Handles

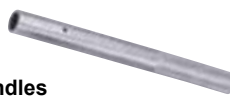

ITEM NO.	Length mm
680350	350
680580	580
680850	850

3/4" Dr. Hand Socket Sets

EU-615M 15pcs Metric Hand Socket Set

- 11 3/4" Dr. Socket (625222 ~ 625250)
22 - 24 - 27 - 30 - 32 - 33 - 34 - 36 - 41 - 46 - 50mm
- 2 Ext. 200 - 400mmL (620200 ~ -400)
- 1 Sliding T-Handle (680060)
- 1 Ratchet (680610S)

13 Kg 1 Sets / 14 Kgs / 0.91 CUFT



GS-627M 27pcs Metric Hand Socket Set

- 27 3/4" Dr. Socket (625217 ~ 625260)
17 - 19 - 20 - 21 - 22 - 23 - 24 - 27 - 30 - 31 - 32 - 33 - 34 - 35 - 36 - 37 - 38 - 40 - 41 - 45 - 46 - 48 - 50 - 54 - 55 - 57 - 60mm

16.5 Kg 1 Set / 18 Kgs / 0.91 CUFT



SS-619S 19pcs SAE Hand Socket Set

- 19 3/4" Dr. Socket (685224 ~ 685272)
3/4 - 13/16 - 7/8 - 15/16 - 1" - 1 1/16 - 1 1/8 - 1 1/4 - 1 5/16 - 1 3/8 - 1 7/16 - 1 1/2 - 1 5/8 - 1 3/4 - 1 7/8 - 2" - 2 1/8 - 2 3/16 - 2 1/4"

11 Kg 2 Sets / 23 Kgs / 0.92 CUFT



GS-627S 27pcs SAE Hand Socket Set

- 27 3/4" Dr. Socket (685224 ~ 685276)
3/4 - 25/32 - 13/16 - 7/8 - 15/16 - 1" - 1 1/16 - 1 1/8 - 1 3/16 - 1 1/4 - 1 5/16 - 1 3/8 - 1 7/16 - 1 1/2 - 1 9/16 - 1 5/8 - 1 11/16 - 1 3/4 - 1 13/16 - 1 7/8 - 1 15/16 - 2" - 2 1/16 - 2 1/8 - 2 3/16 - 2 1/4 - 2 3/8"

18 Kg 1 Set / 19 Kgs / 0.91 CUFT



3/4" Dr. Socket Sets w/ Knurled Handle

GS-615M 15pcs Metric Hand Socket Set

- 13 3/4" Dr. Socket (625227 ~ 625263)
27 - 30 - 32 - 33 - 35 - 36 - 38 - 41 - 46 - 50 - 55 - 60 - 63mm
- 1 Ext. 150mmL (620150)
- 1 Sliding T-Handle (680060)

12 Kg 1 Set / 13 Kgs / 0.46 CUFT



GS-617M 17pcs Metric Hand Socket Set

- 13 3/4" Dr. Socket (625221 ~ 625250)
21 - 22 - 23 - 24 - 27 - 30 - 32 - 35 - 36 - 38 - 41 - 46 - 50mm
- 2 Ext. 150 - 200mmL (620150 ~ -200)
- 1 Sliding T-Handle (680060)
- 1 Ratchet Head with Handle (680666R)

12 Kg 1 Set / 13 Kgs / 0.46 CUFT



TW-625M 25pcs Metric Hand Socket Set

- 19 3/4" Dr. Socket (635219 ~ 635255)
19 - 21 - 22 - 23 - 24 - 27 - 28 - 29 - 30 - 32 - 33 - 34 - 35 - 36 - 38 - 41 - 46 - 50 - 55mm
- 2 Ext. 100 - 200mmL (620100 ~ -200)
- 1 Sliding T-Handle (680060)
- 1 Tube Handle (680350)
- 1 Hinge Head (680446)
- 1 Ratchet Head (680666)

17.5 Kg 1 Set / 18.5 Kgs / 1.14 CUFT



Hand Sockets

3/4" Dr. Socket Sets w/ Knurled Handle

GS-615S 15pcs SAE Hand Socket Set

13 3/4" Dr. Socket (685232 ~ 685280)
 1" - 1 1/8" - 1 1/4" - 1 3/8" - 1 1/2" -
 1 5/8" - 1 3/4" - 1 7/8" - 2" - 2 1/8" -
 2 1/4" - 2 3/8" - 2 1/2"

1 Ext. 6"L (620150)
 1 Sliding T-Handle (680060)



12 Kg 1 Set / 13 Kgs / 0.46 CUFT

GS-617S 17pcs SAE Hand Socket Set

13 3/4" Dr. Socket (685226 ~ 685260)
 13/16" - 7/8" - 15/16" - 1" - 1 1/16" -
 1 1/8" - 1 1/4" - 1 3/8" - 1 7/16" -
 1 1/2" - 1 5/8" - 1 3/4" - 1 7/8"

2 Ext. 6 - 8"L (620150 ~ 620200)
 1 Sliding T-Handle (680060)
 1 Ratchet Head with Handle (680666R)



12 Kg 1 Set / 13 Kgs / 0.46 CUFT

TW-625S 25pcs SAE Hand Socket Set

19 3/4" Dr. Socket (675224 ~ 675272)
 3/4" - 13/16" - 7/8" - 15/16" - 1" - 1 1/16" -
 1 1/8" - 1 1/4" - 1 5/16" - 1 3/8" - 1 7/16" -
 1 1/2" - 1 5/8" - 1 3/4" - 1 7/8" - 2" -
 2 1/8" - 2 3/16" - 2 1/4"

2 Ext. 4 - 8"L (620100 ~ 620200)
 1 Sliding T-Handle (680060)
 1 Tube Handle (680350)
 1 Hinge Head (680446)
 1 Ratchet Head (680666)



19 Kg 1 Set / 20 Kgs / 1.14 CUFT

TW-628MS 28pcs Metric & SAE Hand Socket Set

10 3/4" Dr. Socket (635222 ~ 635250)
 22 - 24 - 27 - 30 - 32 - 36 - 38 -
 41 - 46 - 50mm

12 3/4" Dr. Socket (685228 ~ 685264)
 7/8" - 15/16" - 1" - 1 1/8" - 1 3/16" -
 1 5/16" - 1 3/8" - 1 7/16" - 1 5/8" -
 1 3/4" - 1 7/8" - 2"

2 Ext. 4 - 8"L (620100 ~ 620200)
 1 Sliding T-Handle (680060)
 1 Tube Handle (680350)
 1 Hinge Head (680446)
 1 Ratchet Head (680666)



19 Kg 1 Set / 20 Kgs / 1.14 CUFT

3/4" Dr. Accessories

I Sliding T-Handle



ITEM NO.	Length mm
680060	500

J Adapters



ITEM NO.	Female Drive	Male Drive	Length mm
620604	3/4"	1/2"	63
620608	3/4"	1"	65

K Universal Joint



ITEM NO.	Length mm
680606	110

L Extension Bars



ITEM NO.	Length mm (Inch)
620100	100 (4")
620150	150 (6")
620200	200 (8")
620250	250 (10")
620400	400 (16")

M L-Handles



ITEM NO.	Length mm
620330L	330
620400L	400

1" Dr. Hand Sockets

Metric Hand Sockets			SAE Hand Sockets		
ITEM NO.	Size mm	Length mm	ITEM NO.	Size Inch	Length mm
827017	17	60	887024	3/4	60
827018	18	60	887025	25/32	60
827019	19	60	887026	13/16	60
827020	20	60	887028	7/8	60
827021	21	60	887030	15/16	60
827022	22	60	887032	1	60
827023	23	60	887034	1-1/16	60
827024	24	60	887036	1-1/8	60
827025	25	60	887038	1-3/16	62
827026	26	60	887040	1-1/4	63
827027	27	60	887042	1-5/16	63
827028	28	60	887044	1-3/8	63
827029	29	60	887046	1-7/16	67
827030	30	62	887048	1-1/2	67
827031	31	62	887050	1-9/16	67
827032	32	63	887052	1-5/8	70
827033	33	63	887054	1-11/16	70
827034	34	63	887056	1-3/4	70
827035	35	63	887058	1-13/16	70
827036	36	67	887060	1-7/8	70
827037	37	67	887062	1-15/16	70
827038	38	67	887064	2	70
827039	39	67	887066	2-1/16	82
827040	40	67	887068	2-1/8	82
827041	41	70	887070	2-3/16	87
827042	42	70	887072	2-1/4	87
827043	43	70	887074	2-5/16	87
827044	44	70	887076	2-3/8	91
827045	45	70	887078	2-7/16	91
827046	46	70	887080	2-1/2	91
827047	47	70	887082	2-9/16	95
827048	48	70	887084	2-5/8	95
827049	49	70	887086	2-11/16	95
827050	50	70	887088	2-3/4	100
827051	51	70	887090	2-13/16	100
827052	52	82	887092	2-7/8	100
827053	53	82	887094	2-15/16	105
827054	54	82	887096	3	105
827055	55	87	887098	3-1/16	105
827056	56	87	887100	3-1/8	105
827057	57	87	887102	3-3/16	105
827058	58	87	887104	3-1/4	105
827059	59	87	887106	3-5/16	105
827060	60	91	887108	3-3/8	110
827061	61	91	887110	3-7/16	110
827062	62	91	887112	3-1/2	110
827063	63	91	887114	3-9/16	110
827064	64	91	887116	3-5/8	110
827065	65	95	887118	3-11/16	110
827066	66	95	887120	3-3/4	120
827067	67	95	887122	3-13/16	120
827068	68	95	887124	3-7/8	120
827069	69	95	887126	3-15/16	120
827070	70	100	887128	4	120
827071	71	100	887130	4-1/16	120
827072	72	100	887132	4-1/8	120
827073	73	100	887134	4-3/16	120
827074	74	100	887136	4-1/4	120
827075	75	105	887138	4-5/16	120
827076	76	105	887140	4-3/8	120
827077	77	105	887142	4-7/16	120
827078	78	105	887144	4-1/2	120
827079	79	105			
827080	80	105			
827082	82	105			
827083	83	105			
827085	85	110			
827090	90	110			
827095	95	120			
827100	100	120			
827105	105	120			
827110	110	120			
827115	115	120			

A Universal Joint



ITEM NO.	Length mm
880808	130

1" Dr. Hand Sockets

12 pt. Metric Hand Sockets



ITEM NO.	Size mm	Length mm
837017	17	60
837018	18	60
837019	19	60
837020	20	60
837021	21	60
837022	22	60
837023	23	60
837024	24	60
837025	25	60
837026	26	60
837027	27	60
837028	28	60
837029	29	60
837030	30	62
837031	31	62
837032	32	63
837033	33	63
837034	34	63
837035	35	63
837036	36	67
837037	37	67
837038	38	67
837039	39	67
837040	40	67
837041	41	70
837042	42	70
837043	43	70
837044	44	70
837045	45	70
837046	46	70
837047	47	70
837048	48	70
837049	49	70
837050	50	70
837051	51	70
837052	52	82
837053	53	82
837054	54	82
837055	55	87
837056	56	87
837057	57	87
837058	58	87
837059	59	87
837060	60	91
837061	61	91
837062	62	91
837063	63	91
837064	64	91
837065	65	95
837066	66	95
837067	67	95
837068	68	95
837069	69	95
837070	70	100
837071	71	100
837072	72	100
837073	73	100
837074	74	100
837075	75	105
837076	76	105
837077	77	105
837078	78	105
837079	79	105
837080	80	105
837082	82	105
837083	83	105
837085	85	110
837090	90	110
837095	95	120

12 pt. SAE Hand Sockets



ITEM NO.	Size Inch	Length mm
877024	3/4	60
877025	25/32	60
877026	13/16	60
877028	7/8	60
877030	15/16	60
877032	1	60
877034	1-1/16	60
877036	1-1/8	60
877038	1-3/16	62
877040	1-1/4	63
877042	1-5/16	63
877044	1-3/8	63
877046	1-7/16	67
877048	1-1/2	67
877050	1-9/16	67
877052	1-5/8	70
877054	1-11/16	70
877056	1-3/4	70
877058	1-13/16	70
877060	1-7/8	70
877062	1-15/16	70
877064	2	70
877066	2-1/16	82
877068	2-1/8	82
877070	2-3/16	87
877072	2-1/4	87
877074	2-5/16	87
877076	2-3/8	91
877078	2-7/16	91
877080	2-1/2	91
877082	2-9/16	95
877084	2-5/8	95
877086	2-11/16	95
877088	2-3/4	100
877090	2-13/16	100
877092	2-7/8	100
877094	2-15/16	105
877096	3	105
877098	3-1/16	105
877100	3-1/8	105
877102	3-3/16	105
877104	3-1/4	105
877106	3-5/16	105
877108	3-3/8	110
877110	3-7/16	110
877112	3-1/2	110
877114	3-9/16	110
877116	3-5/8	110
877118	3-11/16	110
877120	3-3/4	120

B Ratchet with Tube Handle

ITEM NO.	Length mm
880888R	800

C Hinge Head with Tube Handle

ITEM NO.	Length mm
880846E	815

D Sliding T-Handles

ITEM NO.	Length mm
880063	630
880080	750

1" Dr. Hand Socket Sets

GS-817M 17pcs Metric Hand Socket Set

- 17 1" Dr. Socket (827024 ~ 827075)
- 24 - 27 - 30 - 32 - 33 - 35 - 36 - 38 - 41 - 46 - 50 - 54 - 55 - 60 - 65 - 70 - 75mm

20 Kg 1 Set / 21 Kgs / 1.41 CUFT



GS-815M 15pcs Metric Hand Socket Set

- 12 1" Dr. Socket (827030 ~ 827063)
- 30 - 32 - 33 - 35 - 36 - 38 - 41 - 46 - 50 - 55 - 60 - 63mm
- 2 Ext. 150 - 200mmL (820150 ~ 820200)
- 1 Ratchet Handle (880888R)

19 Kg 1 Set / 20 Kgs / 0.82 CUFT



GS-816M 16pcs Metric Hand Socket Set

- 7 1" Dr. Socket (837036 ~ 837055)
- 36 - 38 - 41 - 43 - 46 - 50 - 55mm
- 5 1" Dr. Socket (827060 ~ 827080)
- 60 - 65 - 70 - 75 - 80mm
- 2 Ext. 200 - 400mmL (820200 ~ 820400)
- 1 Sliding T-Handle (880063)
- 1 Ratchet Handle (880888R)

36 Kg 1 Set / 37 Kgs / 0.82 CUFT



GS-815S 15pcs SAE Hand Socket Set

- 12 1" Dr. Socket (887036 ~ 887080)
- 1 1/8 - 1 1/4 - 1 3/8 - 1 1/2 - 1 5/8 - 1 3/4 - 1 7/8 - 2" - 2 1/8 - 2 1/4 - 2 3/8 - 2 1/2"
- 2 Ext. 6 - 8"L (820150 ~ 820200)
- 1 Ratchet Handle (880888R)

20 Kg 1 Set / 21 Kgs / 0.82 CUFT



GS-816S 16pcs SAE Hand Socket Set

- 6 1" Dr. Socket (877046 ~ 877072)
- 1 7/16 - 1 1/2 - 1 11/16 - 1 7/8 - 2" - 2 1/4"
- 6 1" Dr. Socket (887076 ~ 887100)
- 2 3/8 - 2 1/2 - 2 5/8 - 2 3/4 - 2 15/16 - 3 1/8"
- 2 Ext. 8 - 16"L (820200 ~ 820400)
- 1 Sliding T-Handle (880063)
- 1 Ratchet Handle (880888R)

37 Kg 1 Set / 38 Kgs / 0.82 CUFT



GS-817S 17pcs SAE Hand Socket Set

- 17 1" Dr. Socket (887046 ~ 887100)
- 1 7/16 - 1 1/2 - 1 5/8 - 1 11/16 - 1 3/4 - 1 13/16 - 1 7/8 - 2" - 2 1/8 - 2 3/16 - 2 1/4 - 2 3/8 - 2 1/2 - 2 5/8 - 2 3/4 - 2 15/16 - 3 1/8"

26 Kg 1 Set / 27 Kgs / 1.41 CUFT



E Extension Bars

ITEM NO.	Length mm (Inch)
820150	150 (6")
820200	200 (8")
820250	250 (10")
820400	400 (16")

F Adapters

ITEM NO.	Female Drive	Male Drive	Length mm
821006	1"	3/4"	70
821012	1"	1 1/2"	80

Head Drivers

3/8" Dr. Head Drivers

Metric Hex Head Drivers



ITEM NO.	Size mm	Length mm
345204	4	52
345205	5	52
345206	6	52
345207	7	52
345208	8	52
345209	9	52
345210	10	52
345212	12	52
345214	14	52
345216	16	52
345217	17	52

Star Head Drivers



ITEM NO.	Size	Length mm
3452S10	T-10	52
3452S15	T-15	52
3452S20	T-20	52
3452S25	T-25	52
3452S27	T-27	52
3452S30	T-30	52
3452S40	T-40	52
3452S45	T-45	52
3452S50	T-50	52
3452S55	T-55	52
3452S60	T-60	52

346004	4	60
346005	5	60
346006	6	60
346007	7	60
346008	8	60
346009	9	60
346010	10	60
346012	12	60
346014	14	60
346016	16	60
346017	17	60

3460S10	T-10	60
3460S15	T-15	60
3460S20	T-20	60
3460S25	T-25	60
3460S27	T-27	60
3460S30	T-30	60
3460S40	T-40	60
3460S45	T-45	60
3460S50	T-50	60
3460S55	T-55	60
3460S60	T-60	60

347604	4	76
347605	5	76
347606	6	76
347607	7	76
347608	8	76
347609	9	76
347610	10	76
347612	12	76
347614	14	76
347616	16	76
347617	17	76

3476S10	T-10	76
3476S15	T-15	76
3476S20	T-20	76
3476S25	T-25	76
3476S27	T-27	76
3476S30	T-30	76
3476S40	T-40	76
3476S45	T-45	76
3476S50	T-50	76
3476S55	T-55	76
3476S60	T-60	76

SAE Hex Head Drivers



ITEM NO.	Size Inch	Length mm
365205	5/32	52
365206	3/16	52
365207	7/32	52
365208	1/4	52
365210	5/16	52
365212	3/8	52
365214	7/16	52
365216	1/2	52
365218	9/16	52
365220	5/8	52

Triple Square Head Drivers



ITEM NO.	Size	Length mm
3452T05	M5	52
3452T06	M6	52
3452T08	M8	52
3452T10	M10	52
3452T12	M12	52
3460T05	M5	60
3460T06	M6	60
3460T08	M8	60
3460T10	M10	60
3460T12	M12	60

3476T05	M5	76
3476T06	M6	76
3476T08	M8	76
3476T10	M10	76
3476T12	M12	76

3/8" Dr. Head Drivers

Slotted Head Drivers



ITEM NO.	T x W mm	Length mm
3452P055	1.0 x 5.5	52
3452P08	1.2 x 8.0	52
3452P10	1.6 x 10.0	52

3460P055	1.0 x 5.5	60
3460P08	1.2 x 8.0	60
3460P10	1.6 x 10.0	60

3476P055	1.0 x 5.5	76
3476P08	1.2 x 8.0	76
3476P10	1.6 x 10.0	76

Philips Head Drivers



ITEM NO.	Size	Length mm
3452R01	#1	52
3452R02	#2	52
3452R03	#3	52
3452R04	#4	52

3460R01	#1	60
3460R02	#2	60
3460R03	#3	60
3460R04	#4	60

3476R01	#1	76
3476R02	#2	76
3476R03	#3	76
3476R04	#4	76

3/8" Dr. Head Driver Sets

TH-310M 10pcs Metric Hex Head Driver Set

10 3/8" Dr. Hex Head (345204 ~ 345217)
4 - 5 - 6 - 7 - 8 - 10 - 12 - 14 - 16 - 17mm(52mmL)

900g 20 Sets / 21 Kgs / 0.88 CUFT

TH-310S 10pcs SAE Hex Head Driver Set

10 3/8" Dr. Hex Head (365205 ~ 365220)
5/32 - 3/16 - 7/32 - 1/4 - 5/16 - 3/8 - 7/16 - 1/2 - 9/16 - 5/8"(52mmL)

900g 20 Sets / 21 Kgs / 0.88 CUFT

TX-311 11pcs Star Head Driver Set

11 3/8" Dr. Star Head (3460S10 ~ 3460S60)
T10 - 15 - 20 - 25 - 27 - 30 - 40 - 45 - 50 - 55 - 60(60mmL)

580g 40 Sets / 24.5 Kgs / 1.07 CUFT

TM-305 5pcs Triple Square Head Driver Set

5 3/8" Dr. Triple Square (3476T05 ~ 3476T12)
M5 - 6 - 8 - 10 - 12(76mmL)

650g 20 Sets / 14 Kgs / 0.67 CUFT

TX-321 21pcs Star Head Driver Component Set

11 3/8" Dr. Star (3460S10 ~ 3460S60)
T10 - 15 - 20 - 25 - 27 - 30 - 40 - 45 - 50 - 55 - 60(60mmL)

3 3/8" Dr. Slotted (3460P055 ~ 3460P10)
5.5 - 8 - 10mm(60mmL)

4 3/8" Dr. Philips (3460R01 ~ 3460R04)
#1 - 2 - 3 - 4(60mmL)

1 Impact Extension 3"L (340075B)

1 Sliding T-Handle (380030)

1 Ratchet (380333R)

2460g 6 Sets / 16 Kgs / 0.7 CUFT

1/2" Dr. Head Drivers



Metric Hex Head Drivers

ITEM NO.	Size mm	Length mm
446004	4	60
446005	5	60
446006	6	60
446007	7	60
446008	8	60
446009	9	60
446010	10	60
446012	12	60
446014	14	60
446016	16	60
446017	17	60
446019	19	60
446021	21	60



Star Head Drivers

ITEM NO.	Size	Length mm
4460S10	T-10	60
4460S15	T-15	60
4460S20	T-20	60
4460S25	T-25	60
4460S27	T-27	60
4460S30	T-30	60
4460S40	T-40	60
4460S45	T-45	60
4460S50	T-50	60
4460S55	T-55	60
4460S60	T-60	60
4460S70	T-70	60

447604	4	76
447605	5	76
447606	6	76
447607	7	76
447608	8	76
447609	9	76
447610	10	76
447612	12	76
447614	14	76
447616	16	76
447617	17	76
447619	19	76
447621	21	76

4476S10	T-10	76
4476S15	T-15	76
4476S20	T-20	76
4476S25	T-25	76
4476S27	T-27	76
4476S30	T-30	76
4476S40	T-40	76
4476S45	T-45	76
4476S50	T-50	76
4476S55	T-55	76
4476S60	T-60	76
4476S70	T-70	76



SAE Hex Head Drivers

ITEM NO.	Size Inch	Length mm
466005	5/32	60
466006	3/16	60
466007	7/32	60
466008	1/4	60
466010	5/16	60
466012	3/8	60
466014	7/16	60
466016	1/2	60
466018	9/16	60
466020	5/8	60
466022	11/16	60
466024	3/4	60
466026	13/16	60



Triple Square Head Drivers

ITEM NO.	Size	Length mm
4460T05	M05	60
4460T06	M06	60
4460T08	M08	60
4460T10	M10	60
4460T12	M12	60

4476T05	M05	76
4476T06	M06	76
4476T08	M08	76
4476T10	M10	76
4476T12	M12	76
4476T14	M14	76
4476T16	M16	76



Slotted Head Drivers

ITEM NO.	T x W mm	Length mm
4460P08	1.2 x 8.0	60
4460P10	1.6 x 10	60
4460P12	2.0 x 12	60
4460P14	2.5 x 14	60
4460P16	2.5 x 16	60



Phillips Head Drivers

ITEM NO.	Size	Length mm
4460R01	#1	60
4460R02	#2	60
4460R03	#3	60
4460R04	#4	60

4476P08	1.2 x 8.0	76
4476P10	1.6 x 10	76
4476P12	2.0 x 12	76
4476P14	2.5 x 14	76
4476P16	2.5 x 16	76

4476R01	#1	76
4476R02	#2	76
4476R03	#3	76
4476R04	#4	76

1/2" Dr. Head Driver Sets

TH-408MD 8pcs Metric Hex Head Driver Set

8 1/2" Dr. Hex Head (447605 ~ 447619)
5 - 6 - 8 - 10 - 12 - 14 - 17 - 19mm(76mmL)

1150g 20 Sets / 24 Kgs / 0.73 CUFT

TH-411M 11pcs Metric Hex Head Driver Set

11 1/2" Dr. Hex Head (446005 ~ 446019)
5 - 6 - 7 - 8 - 9 - 10 - 12 - 14 - 16 - 17 - 19mm(60mmL)

1300g 12 Sets / 17 Kgs / 0.73 CUFT

TH-410S 10pcs SAE Hex Head Driver Set

10 1/2" Dr. Hex Head (466006 ~ 466024)
3/16 - 7/32 - 1/4 - 5/16 - 3/8 - 7/16 - 1/2 - 9/16 - 5/8 - 3/4" (60mmL)

1130g 12 Sets / 15 Kgs / 0.73 CUFT

TM-405 5pcs Triple Square Head Driver Set

5 1/2" Dr. Triple Square (4476T05 ~ 4476T12)
M5 - 6 - 8 - 10 - 12(76mmL)

700g 20 Sets / 15 Kgs / 0.67 CUFT

3/4" Dr. Head Drivers



ITEM NO.	Size mm	Length mm
648814	14	88
648817	17	88
648819	19	88
648821	21	88
648822	22	88
648824	24	88
648827	27	88
648830	30	88
648832	32	88

ITEM NO.	Size Inch	Length mm
668824	3/4	88
668826	13/16	88
668828	7/8	88
668830	15/16	88
668832	1	88
668834	1-1/16	88
668836	1-1/8	88
668838	1-3/16	88
668840	1-1/4	88

1" Dr. Head Drivers



ITEM NO.	Size mm	Length mm
849819	19	98
849821	21	98
849822	22	98
849824	24	98
849826	26	98
849827	27	98
849830	30	98
849832	32	98
849833	33	98
849836	36	98

ITEM NO.	Size Inch	Length mm
869824	3/4	98
869826	13/16	98
869828	7/8	98
869830	15/16	98
869832	1	98
869834	1-1/16	98
869836	1-1/8	98
869838	1-3/16	98
869840	1-1/4	98
869842	1-5/16	98
869844	1-3/8	98

Head Drivers

3/4" Dr. Bit Sockets

Metric Hex Bit Sockets

ITEM NO.	Size mm	Length mm
619+2914	14	80
619+2916	16	80
619+2917	17	80
619+2918	18	80
619+2919	19	80
622+2922	22	85
622+2924	24	85
627+2927	27	90
627+2930	30	90
627+2932	32	90

SAE Hex Bit Sockets

ITEM NO.	Size Inch	Length mm
619+3936	9/16	80
619+3940	5/8	80
619+3948	3/4	80
622+3952	13/16	85
622+3956	7/8	85
622+3960	15/16	85
622+3964	1	85
627+3968	1-1/16	90
627+3972	1-1/8	90
627+3976	1-3/16	90
627+3980	1-1/4	90

Star Bit Sockets

ITEM NO.	Size	Length mm
619+6980	T-80	95
619+6990	T-90	95
619+6995	T-100	95

Triple Square Bit Sockets

ITEM NO.	Size	Length mm
619+9916	M16	95
619+9918	M18	95

3/4" Dr. Bit Socket Sets

BS-614H 14pcs Metric Hex Bit Socket Set

- 10 19mm Shank Hex Bit (2914 ~ 2919)
14 - 16 - 17 - 18 - 19mm
22mm Shank Hex Bit (2922 ~ 2924)
22 - 24mm
27mm Shank Hex Bit (2927 ~ 2932)
27 - 30 - 32mm
 - 3 3/4" Dr. Bit Holder : 19 - 22 - 27mm Shank
 - 1 Hex Key : 4mm (570740)
- 3120g 8 Sets / 26 Kgs / 0.88 CUFT



BS-615H 15pcs SAE Hex Bit Socket Set

- 11 19mm Shank Hex Bit (3936 ~ 3948)
9/16 - 5/8 - 3/4"
 - 22mm Shank Hex Bit (3952 ~ 3964)
13/16 - 7/8 - 15/16 - 1"
 - 27mm Shank Hex Bit (3968 ~ 3980)
1 1/16 - 1 1/8 - 1 3/16 - 1 1/4"
 - 3 3/4" Dr. Bit Holder : 19 - 22 - 27mm Shank
 - 1 Hex Key : 4mm (570740)
- 3500g 8 Sets / 29 Kgs / 0.88 CUFT



3/4" & 1" Dr. Bit Socket Sets

BS-6817H 17pcs 3/4" & 1" Drive Metric Hex Bit Socket Set

- 12 19mm Shank Hex Bit (2914 ~ 2919)
14 - 16 - 17 - 18 - 19mm
22mm Shank Hex Bit (2922 ~ 2924)
22 - 24mm
27mm Shank Hex Bit (2927 ~ 2932)
27 - 30 - 32mm
32mm Shank Hex Bit (2933 ~ 2936)
33 - 36mm
 - 4 3/4" Dr. Bit Holder (619+ ~ 622+)
19 - 22mm Shank
1" Dr. Bit Holder (827+ ~ 832+)
27 - 32mm Shank
 - 1 Hex Key : 4mm (570740)
- 5000g 4 Sets / 21 Kgs / 0.85 CUFT



1" Dr. Bit Sockets

Metric Hex Bit Sockets

ITEM NO.	Size mm	Length mm
819+2916	16	85
819+2917	17	85
819+2918	18	85
819+2919	19	85
822+2922	22	90
822+2924	24	90
827+2927	27	95
827+2930	30	95
827+2932	32	95
832+2933	33	100
832+2936	36	100

SAE Hex Bit Sockets

ITEM NO.	Size Inch	Length mm
819+3940	5/8	85
819+3948	3/4	85
822+3952	13/16	90
822+3956	7/8	90
822+3960	15/16	90
822+3964	1	90
827+3968	1-1/16	95
827+3972	1-1/8	95
827+3976	1-3/16	95
827+3980	1-1/4	95
832+3984	1-5/16	100
832+3988	1-3/8	100

1" Dr. Bit Socket Sets

BS-816H 16pcs Metric Hex Bit Socket Set

- 11 19mm Shank Hex Bit (2916 ~ 2919)
16 - 17 - 18 - 19mm
22mm Shank Hex Bit (2922 ~ 2924)
22 - 24mm
27mm Shank Hex Bit (2927 ~ 2932)
27 - 30 - 32mm
32mm Shank Hex Bit (2933 ~ 2936)
33 - 36mm
 - 4 1" Dr. Bit Holder (819+ ~ 832+)
19 - 22 - 27 - 32mm Shank
 - 1 Hex Key : 4mm (570740)
- 5250g 4 Sets / 22 Kgs / 0.85 CUFT



BS-817H 17pcs SAE Hex Bit Socket Set

- 12 19mm Shank Hex Bit (3940 ~ 3948)
5/8 - 3/4"
 - 22mm Shank Hex Bit (3952 ~ 3964)
13/16 - 7/8 - 15/16 - 1"
 - 27mm Shank Hex Bit (3968 ~ 3980)
1 1/16 - 1 1/8 - 1 3/16 - 1 1/4"
 - 32mm Shank Hex Bit (3984 ~ 3988)
1 5/16 - 1 3/8"
 - 4 1" Dr. Bit Holder (819+ ~ 832+)
19 - 22 - 27 - 32mm Shank
 - 1 Hex Key : 4mm (570740)
- 5750g 4 Sets / 24 Kgs / 0.85 CUFT



BS-6818H 18pcs 3/4" & 1" Drive SAE Hex Bit Socket Set

- 12 19mm Shank Hex Bit (3936 ~ 3948)
9/16 - 5/8 - 3/4"
 - 22mm Shank Hex Bit (3952 ~ 3964)
13/16 - 7/8 - 15/16 - 1"
 - 27mm Shank Hex Bit (3968 ~ 3980)
1 1/16 - 1 1/8 - 1 3/16 - 1 1/4"
 - 32mm Shank Hex Bit (3984 ~ 3988)
1 5/16 - 1 3/8"
 - 4 3/4" Dr. Bit Holder (619+ ~ 622+)
19 - 22mm Shank
1" Dr. Bit Holder (827+ ~ 832+)
27 - 32mm Shank
 - 1 Hex Key : 4mm (570740)
- 5500g 4 Sets / 23 Kgs / 0.85 CUFT



1/4" Dr. Bit Sockets

Slotted Bit Sockets



ITEM NO.	Size mm	Length mm
208+1130	0.5X3.0	45
208+1140	0.6X4.0	45
208+1150	0.8X5.0	45
208+1155	0.8X5.5	45
208+1160	1.0X6.0	45
208+1170	1.2X7.0	45

208+1330	0.5X3.0	70
208+1340	0.6X4.0	70
208+1350	0.8X5.0	70
208+1360	1.0X6.0	70

208+1530	0.5X3.0	100
208+1540	0.6X4.0	100
208+1550	0.8X5.0	100
208+1560	1.0X6.0	100

Metric Hex Bit Sockets



ITEM NO.	Size mm	Length mm
208+2122	2	45
208+2125	2.5	45
208+2133	3	45
208+2134	4	45
208+2135	5	45
208+2136	6	45

208+2322	2	70
208+2325	2.5	70
208+2333	3	70
208+2334	4	70
208+2335	5	70
208+2336	6	70

208+2522	2	100
208+2525	2.5	100
208+2533	3	100
208+2534	4	100
208+2535	5	100
208+2536	6	100

SAE Wobble Bit Sockets



ITEM NO.	Size Inch	Length mm
208+5108	1/8	45
208+5110	5/32	45
208+5112	3/16	45
208+5114	7/32	45
208+5116	1/4	45

208+5308	1/8	70
208+5310	5/32	70
208+5312	3/16	70
208+5314	7/32	70
208+5316	1/4	70

208+5508	1/8	100
208+5510	5/32	100
208+5512	3/16	100
208+5514	7/32	100
208+5516	1/4	100

Philips Bit Sockets



ITEM NO.	Size	Length mm
208+1100	#0	45
208+1101	#1	45
208+1102	#2	45
208+1103	#3	45

208+1301	#1	70
208+1302	#2	70
208+1303	#3	70

208+1501	#1	100
208+1502	#2	100
208+1503	#3	100

SAE Hex Bit Sockets



ITEM NO.	Size Inch	Length mm
208+3104	1/16	45
208+3105	5/64	45
208+3106	3/32	45
208+3107	7/64	45
208+3108	1/8	45
208+3110	5/32	45
208+3112	3/16	45
208+3114	7/32	45
208+3116	1/4	45

208+3304	1/16	70
208+3305	5/64	70
208+3306	3/32	70
208+3307	7/64	70
208+3308	1/8	70
208+3310	5/32	70
208+3312	3/16	70
208+3314	7/32	70
208+3316	1/4	70

208+3504	1/16	100
208+3505	5/64	100
208+3506	3/32	100
208+3507	7/64	100
208+3508	1/8	100
208+3510	5/32	100
208+3512	3/16	100
208+3514	7/32	100
208+3516	1/4	100

Metric Wobble Bit Sockets



ITEM NO.	Size mm	Length mm
208+4133	3	45
208+4134	4	45
208+4135	5	45
208+4136	6	45

208+4333	3	70
208+4334	4	70
208+4335	5	70
208+4336	6	70

208+4533	3	100
208+4534	4	100
208+4535	5	100
208+4536	6	100

1/4" Dr. Bit Sockets

Star Bit Sockets



ITEM NO.	Size	Length mm
208+6106	T-6	45
208+6107	T-7	45
208+6108	T-8	45
208+6109	T-9	45
208+6110	T-10	45
208+6115	T-15	45
208+6120	T-20	45
208+6125	T-25	45
208+6127	T-27	45
208+6130	T-30	45
208+6140	T-40	45

208+6306	T-6	70
208+6307	T-7	70
208+6308	T-8	70
208+6309	T-9	70
208+6310	T-10	70
208+6315	T-15	70
208+6320	T-20	70
208+6325	T-25	70
208+6327	T-27	70
208+6330	T-30	70
208+6340	T-40	70

208+6506	T-6	100
208+6507	T-7	100
208+6508	T-8	100
208+6509	T-9	100
208+6510	T-10	100
208+6515	T-15	100
208+6520	T-20	100
208+6525	T-25	100
208+6527	T-27	100
208+6530	T-30	100
208+6540	T-40	100

Triple Square Bit Sockets



ITEM NO.	Size	Length mm
208+8104	M4	45
208+8105	M5	45
208+8106	M6	45

208+8304	M4	70
208+8305	M5	70
208+8306	M6	70

208+8504	M4	100
208+8505	M5	100
208+8506	M6	100

Tamperproof Star Bit Sockets



ITEM NO.	Size	Length mm
208+7107	T-7	45
208+7108	T-8	45
208+7109	T-9	45
208+7110	T-10	45
208+7115	T-15	45
208+7120	T-20	45
208+7125	T-25	45
208+7127	T-27	45
208+7130	T-30	45
208+7140	T-40	45

208+7307	T-7	70
208+7308	T-8	70
208+7309	T-9	70
208+7310	T-10	70
208+7315	T-15	70
208+7320	T-20	70
208+7325	T-25	70
208+7327	T-27	70
208+7330	T-30	70
208+7340	T-40	70

208+7507	T-7	100
208+7508	T-8	100
208+7509	T-9	100
208+7510	T-10	100
208+7515	T-15	100
208+7520	T-20	100
208+7525	T-25	100
208+7527	T-27	100
208+7530	T-30	100
208+7540	T-40	100

Spanner Bit Sockets



ITEM NO.	Size	Length mm
208+9054	SP4	45
208+9056	SP6	45
208+9058	SP8	45
208+9060	SP10	45
208+9062	SP12	45
208+9064	SP14	45

208+9254	SP4	70
208+9256	SP6	70
208+9258	SP8	70
208+9260	SP10	70
208+9262	SP12	70
208+9264	SP14	70

1/4" Dr. Bit Sockets are also available in 100mmL & 140mmL. Please contact us for more details.

Bit Sockets

1/4" Dr. Bit Sockets

Pentacle Bit Sockets



Ribe Bit Sockets



ITEM NO.	Size	Length mm
208+5008	T-8	45
208+5010	T-10	45
208+5015	T-15	45
208+5020	T-20	45
208+5025	T-25	45
208+5027	T-27	45
208+5030	T-30	45

ITEM NO.	Size	Length mm
208+9004	M4	45
208+9005	M5	45
208+9006	M6	45
208+9204	M4	70
208+9205	M5	70
208+9206	M6	70

208+5208	T-8	70
208+5210	T-10	70
208+5215	T-15	70
208+5220	T-20	70
208+5225	T-25	70
208+5227	T-27	70
208+5230	T-30	70

208+9404	M4	100
208+9405	M5	100
208+9406	M6	100

208+5408	T-8	100
208+5410	T-10	100
208+5415	T-15	100
208+5420	T-20	100
208+5425	T-25	100
208+5427	T-27	100
208+5430	T-30	100

1/4" Dr. Bit Sockets

BS-207S 7pcs Slotted & Philips Bit Socket Set

4 1/4" Dr. Slotted (208+1130 ~ 208+1160)
3 - 4 - 5 - 6mm (45mmL)

3 1/4" Dr. Philips (208+1101 ~ 208+1103)
#1 - 2 - 3 (45mmL)

240g 60 Sets / 15.5 Kgs / 0.92 CUFT

BS-207L 7pcs Slotted & Philips Bit Socket Set

4 1/4" Dr. Slotted (208+1530 ~ 208+1560)
3 - 4 - 5 - 6mm (100mmL)

3 1/4" Dr. Philips (208+1501 ~ 208+1503)
#1 - 2 - 3 (100mmL)

350g 36 Sets / 13.5 Kgs / 0.92 CUFT

BS-214PL 14pcs Slotted & Philips Bit Socket Set

8 1/4" Dr. Slotted (208+1130 ~ 208+1160)
3 - 4 - 5 - 6mm (45mmL)
1/4" Dr. Slotted (208+1630 ~ 208+1660)
3 - 4 - 5 - 6mm (140mmL)

6 1/4" Dr. Philips (208+1101 ~ 208+1103)
#1 - 2 - 3 (45mmL)
1/4" Dr. Philips (208+1601 ~ 208+1603)
#1 - 2 - 3 (140mmL)

800g 10 Sets / 9 Kgs / 0.82 CUFT

BS-206S 6pcs Spanner Bit Socket Set

6 1/4" Dr. Spanner (208+9054 ~ 208+9064)
SP4 - 6 - 8 - 10 - 12 - 14 (45mmL)

160g 60 Sets / 11 Kgs / 0.92 CUFT

3/8" Dr. Bit Sockets

Slotted Bit Sockets



Philips Bit Sockets



ITEM NO.	Size mm	Length mm
308+1140	0.6X4.0	50
308+1150	0.8X5.0	50
308+1160	1.0X6.0	50
310+1280	1.2X8.0	50
310+1290	1.6X9.0	50

ITEM NO.	Size	Length mm
308+1101	#1	50
308+1102	#2	50
308+1103	#3	50
310+1124	#4	50

308+1540	0.6X4.0	110
308+1550	0.8X5.0	110
308+1560	1.0X6.0	110
310+1580	1.2X8.0	110
310+1590	1.6X9.0	110

308+1501	#1	110
308+1502	#2	110
308+1503	#3	110
310+1504	#4	110

308+1640	0.6X4.0	140
308+1650	0.8X5.0	140
308+1660	1.0X6.0	140
310+1680	1.2X8.0	140
310+1690	1.6X9.0	140

308+1601	#1	140
308+1602	#2	140
308+1603	#3	140
310+1604	#4	140

Metric Hex Bit Sockets



SAE Hex Bit Sockets



ITEM NO.	Size mm	Length mm
308+2133	3	50
308+2134	4	50
308+2135	5	50
308+2136	6	50
310+2147	7	50
310+2148	8	50
339+2149	9	50
340+2150	10	50
341+2151	11	50
342+2152	12	50

ITEM NO.	Size Inch	Length mm
308+3108	1/8	50
308+3110	5/32	50
308+3112	3/16	50
308+3114	7/32	50
308+3116	1/4	50
310+3128	9/32	50
310+3130	5/16	50
312+3134	3/8	50
314+3138	7/16	50
316+3142	1/2	50

308+2533	3	110
308+2534	4	110
308+2535	5	110
308+2536	6	110
310+2547	7	110
310+2548	8	110
339+2549	9	110
340+2550	10	110
341+2551	11	110
342+2552	12	110

308+3508	1/8	110
308+3510	5/32	110
308+3512	3/16	110
308+3514	7/32	110
308+3516	1/4	110
310+3518	9/32	110
310+3520	5/16	110
312+3524	3/8	110
314+3528	7/16	110
316+3532	1/2	110

308+2633	3	140
308+2634	4	140
308+2635	5	140
308+2636	6	140
310+2647	7	140
310+2648	8	140
339+2649	9	140
340+2650	10	140
341+2651	11	140
342+2652	12	140

308+3608	1/8	140
308+3610	5/32	140
308+3612	3/16	140
308+3614	7/32	140
308+3616	1/4	140
310+3618	9/32	140
310+3620	5/16	140
312+3624	3/8	140
314+3628	7/16	140
316+3632	1/2	140

3/8" Dr. Bit Sockets

Metric Wobble Bit Sockets



ITEM NO.	Size mm	Length mm
308+4133	3	50
308+4134	4	50
308+4135	5	50
308+4136	6	50
310+4147	7	50
310+4148	8	50
339+4149	9	50
340+4150	10	50

SAE Wobble Bit Sockets



ITEM NO.	Size Inch	Length mm
308+5108	1/8	50
308+5110	5/32	50
308+5112	3/16	50
308+5114	7/32	50
308+5116	1/4	50
310+5118	9/32	50
310+5120	5/16	50
312+5124	3/8	50

308+4533	3	110
308+4534	4	110
308+4535	5	110
308+4536	6	110
310+4547	7	110
310+4548	8	110
339+4549	9	110
340+4550	10	110

308+5508	1/8	110
308+5510	5/32	110
308+5512	3/16	110
308+5514	7/32	110
308+5516	1/4	110
310+5518	9/32	110
310+5520	5/16	110
312+5524	3/8	110

308+4633	3	140
308+4634	4	140
308+4635	5	140
308+4636	6	140
310+4647	7	140
310+4648	8	140
339+4649	9	140
340+4650	10	140

308+5608	1/8	140
308+5610	5/32	140
308+5612	3/16	140
308+5614	7/32	140
308+5616	1/4	140
310+5618	9/32	140
310+5620	5/16	140
312+5624	3/8	140

Star Bit Sockets



ITEM NO.	Size	Length mm
308+6110	T-10	50
308+6115	T-15	50
308+6120	T-20	50
308+6125	T-25	50
308+6127	T-27	50
308+6130	T-30	50
308+6140	T-40	50
310+6245	T-45	50
310+6250	T-50	50
340+6255	T-55	50

Tamperproof Star Bit Sockets



ITEM NO.	Size	Length mm
308+7110	T-10	50
308+7115	T-15	50
308+7120	T-20	50
308+7125	T-25	50
308+7127	T-27	50
308+7130	T-30	50
308+7140	T-40	50
310+7145	T-45	50
310+7150	T-50	50
340+7155	T-55	50

308+6510	T-10	110
308+6515	T-15	110
308+6520	T-20	110
308+6525	T-25	110
308+6527	T-27	110
308+6530	T-30	110
308+6540	T-40	110
310+6545	T-45	110
310+6550	T-50	110
340+6555	T-55	110

308+7510	T-10	110
308+7515	T-15	110
308+7520	T-20	110
308+7525	T-25	110
308+7527	T-27	110
308+7530	T-30	110
308+7540	T-40	110
310+7545	T-45	110
310+7550	T-50	110
340+7555	T-55	110

308+6610	T-10	140
308+6615	T-15	140
308+6620	T-20	140
308+6625	T-25	140
308+6627	T-27	140
308+6630	T-30	140
308+6640	T-40	140
310+6645	T-45	140
310+6650	T-50	140
340+6655	T-55	140

308+7610	T-10	140
308+7615	T-15	140
308+7620	T-20	140
308+7625	T-25	140
308+7627	T-27	140
308+7630	T-30	140
308+7640	T-40	140
310+7645	T-45	140
310+7650	T-50	140
340+7655	T-55	140

3/8" Dr. Bit Sockets

Triple Square Bit Sockets



ITEM NO.	Size	Length mm
308+8104	M4	50
308+8105	M5	50
308+8106	M6	50
310+8108	M8	50
340+8110	M10	50
342+8112	M12	50
344+8114	M14	50

308+8504	M4	110
308+8505	M5	110
308+8506	M6	110
310+8508	M8	110
340+8510	M10	110
342+8512	M12	110
344+8514	M14	110

308+8604	M4	140
308+8605	M5	140
308+8606	M6	140
310+8608	M8	140
340+8610	M10	140
342+8612	M12	140
344+8614	M14	140

Pentacle Bit Sockets



ITEM NO.	Size	Length mm
308+5008	T-8	50
308+5010	T-10	50
308+5015	T-15	50
308+5020	T-20	50
308+5025	T-25	50
308+5027	T-27	50
308+5030	T-30	50
310+5040	T-40	50
310+5045	T-45	50
340+5050	T-50	50
342+5055	T-55	50

308+5408	T-8	110
308+5410	T-10	110
308+5415	T-15	110
308+5420	T-20	110
308+5425	T-25	110
308+5427	T-27	110
308+5430	T-30	110
310+5440	T-40	110
310+5445	T-45	110
340+5450	T-50	110
342+5455	T-55	110

Ribe Bit Sockets



ITEM NO.	Size	Length mm
308+9004	M4	50
308+9005	M5	50
308+9006	M6	50
310+9007	M7	50
310+9008	M8	50
340+9009	M9	50
340+9010	M10	50
342+9012	M12	50
344+9013	M13	50
344+9014	M14	50

308+9404	M4	110
308+9405	M5	110
308+9406	M6	110
310+9407	M7	110
310+9408	M8	110
340+9409	M9	110
340+9410	M10	110
342+9412	M12	110
344+9413	M13	110
344+9414	M14	110



3/8" Dr. Bit Sockets are also available in 180mmL & 220mmL. Please contact us for more details.

3/8" Dr. Bit Socket Sets

BS-309S 9pcs Slotted & Philips Bit Socket Set

5  3/8" Dr. Slotted (308+1140 ~ 310+1290)
4 - 5 - 6 - 8 - 9mm (50mmL)

4  3/8" Dr. Philips (308+1101 ~ 310+1124)
#1 - 2 - 3 - 4 (50mmL)



 500g  20 Sets / 11 Kgs / 0.73 CUFT



BS-309L 9pcs Slotted & Philips Bit Socket Set

5  3/8" Dr. Slotted (308+1540 ~ 310+1590)
4 - 5 - 6 - 8 - 9mm (110mmL)

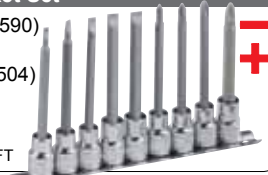

4  3/8" Dr. Philips (308+1501 ~ 310+1504)
#1 - 2 - 3 - 4 (110mmL)

 640g  20 Sets / 14 Kgs / 0.73 CUFT



BS-310HM 10pcs Metric Hex Bit Socket Set

10  3/8" Dr. Hex (308+2133 ~ 342+2152)
3 - 4 - 5 - 6 - 7 - 8 - 9 - 10 -
11 - 12mm (50mmL)

 560g  20 Sets / 13 Kgs / 0.71 CUFT



BS-310HML 10pcs Metric Hex Bit Socket Set



10  3/8" Dr. Hex (308+2533 ~ 342+2552)
3 - 4 - 5 - 6 - 7 - 8 - 9 - 10 -
11 - 12mm (110mmL)

 900g  20 Sets / 19 Kgs / 0.73 CUFT



BS-310HS 10pcs SAE Hex Bit Socket Set



10  3/8" Dr. Hex (308+3108 ~ 316+3142)
1/8 - 5/32 - 3/16 - 7/32 - 1/4 -
9/32 - 5/16 - 3/8 - 7/16 - 1/2"
(50mmL)

 560g  20 Sets / 13 Kgs / 0.71 CUFT



BS-310HSL 10pcs SAE Hex Bit Socket Set



10  3/8" Dr. Hex (308+3608 ~ 316+3632)
1/8 - 5/32 - 3/16 - 7/32 - 1/4 -
9/32 - 5/16 - 3/8 - 7/16 - 1/2"
(140mmL)

 1100g  20 Sets / 23 Kgs / 0.73 CUFT



BS-308WH 8pcs Metric Wobble Hex Bit Socket Set



8  3/8" Dr. Wobble (308+4133 ~ 340+4150)
3 - 4 - 5 - 6 - 7 - 8 - 9 -
10mm (50mmL)

 500g  36 Sets / 19 Kgs / 0.64 CUFT



BS-308WHL 8pcs Metric Wobble Hex Bit Socket

8  3/8" Dr. Wobble (308+4633 ~ 340+4650)
3 - 4 - 5 - 6 - 7 - 8 - 9 -
10mm (140mmL)



 750g  20 Sets / 16 Kgs / 0.73 CUFT



3/8" Dr. Bit Socket Sets

BS-308WHS 8pcs SAE Wobble Hex Bit Socket Set



8  3/8" Dr. Wobble (308+5108 ~ 312+5124)
1/8 - 5/32 - 3/16 - 7/32 - 1/4 -
9/32 - 5/16 - 3/8" (50mmL)

 470g  36 Sets / 18 Kgs / 0.64 CUFT



BS-308WSL 8pcs SAE Wobble Hex Bit Socket Set



8  3/8" Dr. Wobble (308+5508 ~ 312+5524)
1/8 - 5/32 - 3/16 - 7/32 - 1/4 -
9/32 - 5/16 - 3/8" (110mmL)

 620g  20 Sets / 13 Kgs / 0.73 CUFT



BS-310T 10pcs Star Bit Socket Set



10  3/8" Dr. Star (308+6110 ~ 340+6255)
T10 - 15 - 20 - 25 - 27 - 30 -
40 - 45 - 50 - 55 (50mmL)

 460g  20 Sets / 11 Kgs / 0.71 CUFT



BS-310TL 10pcs Star Bit Socket Set

10  3/8" Dr. Star (308+6510 ~ 340+6555)
T10 - 15 - 20 - 25 - 27 - 30 -
40 - 45 - 50 - 55 (110mmL)

 730g  20 Sets / 15.5 Kgs / 0.73 CUFT



BS-310TA 10pcs Tamperproof Star Bit Socket Set

10  3/8" Dr. Tamperproof Star
(308+7110 ~ 340+7155)
T10 - 15 - 20 - 25 - 27 - 30 -
40 - 45 - 50 - 55 (50mmL)

 460g  20 Sets / 11 Kgs / 0.71 CUFT



BS-310TAL 10pcs Tamperproof Star Bit Socket Set



10  3/8" Dr. Tamperproof Star
(308+7510 ~ 340+7555)
T10 - 15 - 20 - 25 - 27 - 30 -
40 - 45 - 50 - 55 (110mmL)

 730g  20 Sets / 16 Kgs / 0.73 CUFT



BS-307M 7pcs Triple Square Bit Socket Set



7  3/8" Dr. Triple Square (308+8104 ~ 344+8114)
M4 - 5 - 6 - 8 - 10 -
12 - 14 (50mmL)

 430g  20 Sets / 9.5 Kgs / 0.44 CUFT



BS-307ML 7pcs Triple Square Bit Socket Set

7  3/8" Dr. Triple Square
(308+8504 ~ 344+8514)
M4 - 5 - 6 - 8 - 10 - 12 - 14 (110mmL)

 720g  20 Sets / 15.5 Kgs / 0.73CUFT





3/8" Dr. Bit Socket Sets

BS-311PL 11pcs Pentacle Bit Socket Set

11  3/8" Dr. Pentacle
(308+5408 ~ 342+5455)
T8 - 10 - 15 - 20 - 25 - 27 - 30 -
40 - 45 - 50 - 55 (110mmL)



 850g  20 Sets / 18 Kgs / 0.73 CUFT

1/4" & 3/8" Dr. Bit Socket Sets

BS-2324HL 24pcs Metric Hex Bit Socket Set



12  1/4" Dr. Hex (208+2122 ~ 208+2136)
2 - 2.5 - 3 - 4 - 5 - 6mm
(45mmL)

1/4" Dr. Hex (208+2622 ~ 208+2636)
2 - 2.5 - 3 - 4 - 5 - 6mm
(140mmL)

12  3/8" Dr. Hex (310+2147 ~ 342+2152)
7 - 8 - 9 - 10 - 11 - 12mm
(50mmL)

3/8" Dr. Hex (310+2647 ~ 342+2652)
7 - 8 - 9 - 10 - 11 - 12mm
(140mmL)



 1700g  10 Sets / 18 Kgs / 1.16 CUFT

BS-2328HL 28pcs SAE Hex Bit Socket Set



18  1/4" Dr. Hex (208+3104 ~ 208+3116)
1/16 - 5/64 - 3/32 - 7/64 - 1/8 -
5/32 - 3/16 - 7/32 - 1/4" (45mmL)

1/4" Dr. Hex (208+3604 ~ 208+3616)
1/16 - 5/64 - 3/32 - 7/64 - 1/8 -
5/32 - 3/16 - 7/32 - 1/4" (140mmL)

10  3/8" Dr. Hex (310+3128 ~ 316+3142)
9/32 - 5/16 - 3/8 - 7/16 - 1/2"
(50mmL)

3/8" Dr. Hex (310+3618 ~ 316+3632)
9/32 - 5/16 - 3/8 - 7/16 - 1/2"
(140mmL)



 1800g  10 Sets / 19 Kgs / 1.16 CUFT

BS-2316WH 16pcs Metric Wobble Hex Bit Socket Set

8  1/4" Dr. Wobble
(208+4133 ~ 208+4136)
3 - 4 - 5 - 6mm (45mmL)

1/4" Dr. Wobble
(208+4633 ~ 208+4636)
3 - 4 - 5 - 6mm (140mmL)

8  3/8" Dr. Wobble (310+4147 ~ 340+4150)
7 - 8 - 9 - 10mm (50mmL)

3/8" Dr. Wobble (310+4647 ~ 340+4650)
7 - 8 - 9 - 10mm (140mmL)



 1200g  10 Sets / 13 Kgs / 0.82 CUFT

BS-2316WS 16pcs SAE Wobble Hex Bit Socket Set



10  1/4" Dr. Wobble
(208+5108 ~ 208+5116)
1/8 - 5/32 - 3/16 - 7/32 - 1/4" (45mmL)

1/4" Dr. Wobble
(208+5608 ~ 208+5616)
1/8 - 5/32 - 3/16 - 7/32 - 1/4" (140mmL)

6  3/8" Dr. Wobble (310+5118 ~ 312+5124)
9/32 - 5/16 - 3/8" (50mmL)

3/8" Dr. Wobble (310+5618 ~ 312+5624)
9/32 - 5/16 - 3/8" (140mmL)



 1100g  10 Sets / 12 Kgs / 0.82 CUFT

1/4" & 3/8" Dr. Bit Socket Sets

BS-2328TL 28pcs Star Bit Socket Set



22  1/4" Dr. Star (208+6106 ~ 208+6140)
T6 - 7 - 8 - 9 - 10 - 15 - 20 -
25 - 27 - 30 - 40 (45mmL)

1/4" Dr. Star (208+6606 ~ 208+6640)
T6 - 7 - 8 - 9 - 10 - 15 - 20 -
25 - 27 - 30 - 40 (140mmL)

6  3/8" Dr. Star
(310+6245 ~ 340+6255)
T45 - 50 - 55 (50mmL)

3/8" Dr. Star
(310+6645 ~ 340+6655)
T45 - 50 - 55 (140mmL)



 1600g  10 Sets / 17 Kgs / 1.16 CUFT

BS-2326TAL 26pcs Tamperproof Star Bit Socket Set

20  1/4" Dr. Tamperproof Star (208+7107 ~ 208+7140)
T7 - 8 - 9 - 10 - 15 - 20 -
25 - 27 - 30 - 40 (45mmL)

1/4" Dr. Tamperproof Star (208+7607 ~ 208+7640)
T7 - 8 - 9 - 10 - 15 - 20 -
25 - 27 - 30 - 40 (140mmL)

6  3/8" Dr. Tamperproof Star
(310+7145 ~ 340+7155)
T45 - 50 - 55 (50mmL)

3/8" Dr. Tamperproof Star
(310+7645 ~ 340+7655)
T45 - 50 - 55 (140mmL)



 1550g  10 Sets / 16.5 Kgs / 1.16 CUFT

BS-2314TR 14pcs Triple Square Bit Socket Set



6  1/4" Dr. Triple Square (208+8104 ~ 208+8106)
M4 - 5 - 6 (45mmL)

1/4" Dr. Triple Square (208+8604 ~ 208+8606)
M4 - 5 - 6 (140mmL)

8  3/8" Dr. Triple Square
(310+8108 ~ 344+8114)
M8 - 10 - 12 - 14 (50mmL)

3/8" Dr. Triple Square
(310+8608 ~ 344+8614)
M8 - 10 - 12 - 14 (140mmL)



 1250g  10 Sets / 13.5 Kgs / 0.82 CUFT

BS-23441 41pcs 1/4", 3/8" & 1/2" Dr. Complete Star Bit Socket

A complete collection of e-star and star bit sockets. This set is tailored for star or tamperproof star screws and nuts that can be found on most of vehicles.



Includes

12 E-Star Sockets
1/4" Dr. E4 - 5 - 6 - 7 - 8
3/8" Dr. E10 - 11 - 12 - 14 - 16
1/2" Dr. E18 - 20

15 Star Bit Sockets
1/4" Dr. T7 - 8 - 9 - 10 - 15 - 20 - 25 -
27 - 30 (45mmL)
3/8" Dr. T40 - 45 - 50 - 55 (50mmL)
1/2" Dr. T60 - 70 (62mmL)

14 Tamperproof Star Bit Sockets
1/4" Dr. T8 - 9 - 10 - 15 - 20 - 25 - 27 -
30 (45mmL)
3/8" Dr. T40 - 45 - 50 - 55 (50mmL)
1/2" Dr. T60 - 70 (62mmL)



 2050g  10 Sets / 21.5 Kgs / 1.16 CUFT

Bit Sockets

1/2" Dr. Bit Sockets



Slotted Bit Sockets

ITEM NO.	Size mm	Length mm
408+1165	1.0X6.5	55
408+1170	1.2X7.0	55
410+1280	1.2X8.0	55
410+1290	1.6X9.0	55
440+1292	2.0X12.0	60
442+1294	2.5X14.0	60
444+1296	2.5X16.0	60

410+1480	1.2X8.0	80
410+1490	1.6X9.0	80
440+1492	2.0X12.0	80
442+1494	2.5X14.0	80
444+1496	2.5X16.0	80

410+1580	1.2X8.0	110
410+1590	1.6X9.0	110
440+1592	2.0X12.0	110
442+1594	2.5X14.0	110
444+1596	2.5X16.0	110



Philips Bit Sockets

ITEM NO.	Size	Length mm
408+1102	#2	55
408+1103	#3	55
410+1124	#4	55

408+1302	#2	80
408+1303	#3	80
410+1404	#4	80

408+1502	#2	110
408+1503	#3	110
410+1504	#4	110



Metric Hex Bit Sockets

ITEM NO.	Size mm	Length mm
408+2134	4	55
408+2135	5	55
408+2136	6	55
410+2147	7	55
410+2148	8	55
439+2149	9	55
440+2150	10	55
441+2151	11	55
442+2152	12	55

408+2334	4	80
408+2335	5	80
408+2336	6	80
410+2347	7	80
410+2348	8	80
439+2349	9	80
440+2350	10	80
441+2351	11	80
442+2352	12	80
443+2353	13	80
444+2354	14	80
446+2356	16	80
447+2357	17	80
449+2359	19	80

408+2534	4	110
408+2535	5	110
408+2536	6	110
410+2547	7	110
410+2548	8	110
439+2549	9	110
440+2550	10	110
441+2551	11	110
442+2552	12	110
443+2553	13	110
444+2554	14	110
446+2556	16	110
447+2557	17	110
449+2559	19	110



SAE Hex Bit Sockets

ITEM NO.	Size Inch	Length mm
408+3112	3/16	55
408+3114	7/32	55
408+3116	1/4	55
410+3128	9/32	55
410+3130	5/16	55
412+3134	3/8	55
414+3138	7/16	55
416+3142	1/2	55

408+3310	5/32	80
408+3312	3/16	80
408+3314	7/32	80
408+3316	1/4	80
410+3318	9/32	80
410+3320	5/16	80
412+3324	3/8	80
414+3328	7/16	80
416+3332	1/2	80
418+3336	9/16	80
420+3340	5/8	80
422+3344	11/16	80
424+3348	3/4	80

408+3510	5/32	110
408+3512	3/16	110
408+3514	7/32	110
408+3516	1/4	110
410+3518	9/32	110
410+3520	5/16	110
412+3524	3/8	110
414+3528	7/16	110
416+3532	1/2	110
418+3536	9/16	110
420+3540	5/8	110
422+3544	11/16	110
424+3548	3/4	110

1/2" Dr. Bit Sockets



Star Bit Sockets

ITEM NO.	Size	Length mm
408+6120	T-20	55
408+6125	T-25	55
408+6127	T-27	55
408+6130	T-30	55
408+6140	T-40	55
410+6245	T-45	55
410+6250	T-50	55
440+6255	T-55	55
442+6260	T-60	60
444+6270	T-70	60

408+6320	T-20	80
408+6325	T-25	80
408+6327	T-27	80
408+6330	T-30	80
408+6340	T-40	80
410+6345	T-45	80
410+6350	T-50	80
440+6355	T-55	80
442+6360	T-60	80
444+6370	T-70	80

408+6520	T-20	110
408+6525	T-25	110
408+6527	T-27	110
408+6530	T-30	110
408+6540	T-40	110
410+6545	T-45	110
410+6550	T-50	110
440+6555	T-55	110
442+6560	T-60	110
444+6570	T-70	110



Tamperproof Star Bit Sockets

ITEM NO.	Size	Length mm
408+7120	T-20	55
408+7125	T-25	55
408+7127	T-27	55
408+7130	T-30	55
408+7140	T-40	55
410+7145	T-45	55
410+7150	T-50	55
440+7155	T-55	55
442+7160	T-60	60
444+7170	T-70	60

408+7320	T-20	80
408+7325	T-25	80
408+7327	T-27	80
408+7330	T-30	80
408+7340	T-40	80
410+7345	T-45	80
410+7350	T-50	80
440+7355	T-55	80
442+7360	T-60	80
444+7370	T-70	80

408+7520	T-20	110
408+7525	T-25	110
408+7527	T-27	110
408+7530	T-30	110
408+7540	T-40	110
410+7545	T-45	110
410+7550	T-50	110
440+7555	T-55	110
442+7560	T-60	110
444+7570	T-70	110



Triple Square Bit Sockets

ITEM NO.	Size	Length mm
408+8104	M4	55
408+8105	M5	55
408+8106	M6	55
410+8108	M8	55
440+8110	M10	55
442+8112	M12	55
444+8114	M14	55
446+8116	M16	60
449+8118	M18	60

408+8304	M4	80
408+8305	M5	80
408+8306	M6	80
410+8308	M8	80
440+8310	M10	80
442+8312	M12	80
444+8314	M14	80
446+8316	M16	80

408+8504	M4	110
408+8505	M5	110
408+8506	M6	110
410+8508	M8	110
440+8510	M10	110
442+8512	M12	110
444+8514	M14	110
446+8516	M16	110



Pentacle Bit Sockets

ITEM NO.	Size	Length mm
408+5020	T-20	55
408+5025	T-25	55
408+5027	T-27	55
408+5030	T-30	55
410+5040	T-40	55
410+5045	T-45	55
440+5050	T-50	55
442+5055	T-55	55

408+5220	T-20	80
408+5225	T-25	80
408+5227	T-27	80
408+5230	T-30	80
410+5240	T-40	80
410+5245	T-45	80
440+5250	T-50	80
442+5255	T-55	80

408+5420	T-20	110
408+5425	T-25	110
408+5427	T-27	110
408+5430	T-30	110
410+5440	T-40	110
410+5445	T-45	110
440+5450	T-50	110
442+5455	T-55	110

1/2" Dr. Bit Sockets

Metric Wobble Bit Sockets



SAE Wobble Bit Sockets



ITEM NO.	Size mm	Length mm
408+4335	5	80
408+4336	6	80
410+4347	7	80
410+4348	8	80
439+4349	9	80
440+4350	10	80

ITEM NO.	Size Inch	Length mm
408+5312	3/16	80
408+5314	7/32	80
408+5316	1/4	80
410+5318	9/32	80
410+5320	5/16	80
412+5324	3/8	80

408+4535	5	110
408+4536	6	110
410+4547	7	110
410+4548	8	110
439+4549	9	110
440+4550	10	110

408+5512	3/16	110
408+5514	7/32	110
408+5516	1/4	110
410+5518	9/32	110
410+5520	5/16	110
412+5524	3/8	110

Ribe Bit Sockets



ITEM NO.	Size	Length mm
408+9004	M4	55
408+9005	M5	55
408+9006	M6	55
410+9007	M7	55
410+9008	M8	55
440+9009	M9	55
440+9010	M10	55
442+9012	M12	55
444+9013	M13	55
444+9014	M14	55
446+9016	M16	55

ITEM NO.	Size	Length mm
408+9404	M4	110
408+9405	M5	110
408+9406	M6	110
410+9407	M7	110
410+9408	M8	110
440+9409	M9	110
440+9410	M10	110
442+9412	M12	110
444+9413	M13	110
444+9414	M14	110
446+9416	M16	110

1/2" Dr. Bit Sockets are also available in 150mmL, 190mmL & 230mmL. Please contact us for more details.

1/2" Dr. Bit Socket Sets

BS-409H 9pcs Metric Hex Bit Socket Set

- 9 1/2" Dr. Hex
(408+2334 ~ 447+2357)
4 - 5 - 6 - 7 - 8 - 10 - 12 -
14 - 17mm (80mmL)



1170g 20 Sets / 24.5 Kgs / 1.5 CUFT

BS-409T 9pcs Star Bit Socket Set

- 9 1/2" Dr. Star
(408+6320 ~ 442+6360)
20 - 25 - 27 - 30 - 40 - 45 -
50 - 55 - 60 (80mmL)



930g 20 Sets / 19.5 Kgs / 1.5 CUFT

1/2" Dr. Bit Socket Sets

BS-407P 7pcs Slotted & Philips Bit Socket Set

- 4 1/2" Dr. Slotted (408+1170 ~ 440+1292)
7 - 8 - 9 mm (55mmL)
12mm (60mmL)
- 3 1/2" Dr. Philips (408+1102 ~ -1124)
2 - 3 - 4 (55mmL)



570g 20 Sets / 12.5 Kgs / 0.71 CUFT

BS-408H 8pcs Metric Hex Bit Socket Set

- 8 1/2" Dr. Hex (408+2134 ~ 442+2152)
4 - 5 - 6 - 7 - 8 - 9 -
10 - 12mm (55mmL)



630g 20 Sets / 13.5 Kgs / 0.71 CUFT

BS-409L 9pcs Metric Hex Bit Socket Set

- 9 1/2" Dr. Hex (408+2134 ~ 440+2150)
4 - 5 - 6 - 8 - 10mm (55mmL)
1/2" Dr. Hex (408+2535 ~ 410+2548)
5 - 6 - 8mm (110mmL)
1/2" Dr. Hex (440+2650)
10mm (150mmL)



900g 10 Sets / 10 Kgs / 0.77 CUFT

BS-407H 7pcs SAE Hex Bit Socket Set

- 7 1/2" Dr. Hex (410+3320 ~ 424+3348)
5/16 - 3/8 - 7/16 - 1/2
9/16 - 5/8 - 3/4"
(80mmL)



1150g 12 Sets / 15 Kgs / 0.71 CUFT

BS-408T 8pcs Star Bit Socket Set

- 8 1/2" Dr. Star (408+6120 ~ 440+6255)
20 - 25 - 27 - 30 - 40 -
45 - 50 - 55 (55mmL)



630g 20 Sets / 13.5 Kgs / 0.71 CUFT

BS-410TA 10pcs Tamperproof Star Bit Socket Set

- 10 1/2" Dr. Tamperproof Star (408+7120 ~ 444+7170)
T20 - 25 - 27 - 30 - 40 -
45 - 50 - 55 (55mmL)
T60 - 70 (60mmL)



880g 15 Sets / 14.5 Kgs / 0.95 CUFT

BS-410TB 10pcs Tamperproof Star Bit Socket Set

- 10 1/2" Dr. Tamperproof Star
(408+7520 ~ 444+7570)
T20 - 25 - 27 - 30 - 40 -
45 - 50 - 55 - 60 - 70
(110mmL)



1220g 12 Sets / 16 Kgs / 0.69 CUFT

BS-410M 10pcs Triple Square Bit Socket Set

- 10 1/2" Dr. Triple Square (408+8105 ~ 444+8114)
M5 - 6 - 8 - 10 - 12 - 14 (55mmL)
1/2" Dr. Triple Square
(408+8506 ~ 442+8512)
M6 - 8 - 10 - 12 (110mmL)



1130g 12 Sets / 14.5 Kgs / 0.69 CUFT

Screwdriver Bits

Screwdriver Bit Holders



ITEM NO.	Drive	Hex Shank	Length mm
208+	1/4"	1/4"	25

308+	3/8"	1/4"	28
310+	3/8"	5/16"	30
312+	3/8"	3/8"	30
314+	3/8"	7/16"	30
316+	3/8"	1/2"	30

339+	3/8"	9mm	30
340+	3/8"	10mm	30
341+	3/8"	11mm	30
342+	3/8"	12mm	30
344+	3/8"	14mm	30

408+	1/2"	1/4"	36
410+	1/2"	5/16"	38
412+	1/2"	3/8"	40
414+	1/2"	7/16"	40
416+	1/2"	1/2"	40
418+	1/2"	9/16"	40
420+	1/2"	5/8"	40
422+	1/2"	11/16"	40
424+	1/2"	3/4"	40

439+	1/2"	9mm	40
440+	1/2"	10mm	40
441+	1/2"	11mm	40
442+	1/2"	12mm	40
443+	1/2"	13mm	40
444+	1/2"	14mm	40
446+	1/2"	16mm	40
447+	1/2"	17mm	40
449+	1/2"	19mm	40

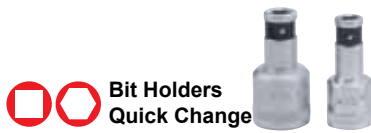

ITEM NO.	Drive	Hex Shank	Length mm
283508	1/4"	1/4"	35
283510	1/4"	5/16"	35

383908	3/8"	1/4"	39
384608	3/8"	1/4"	46
383910	3/8"	5/16"	39
384610	3/8"	5/16"	46
383912	3/8"	3/8"	39
323910	3/8"	10mm	39

484108	1/2"	1/4"	41
484808	1/2"	1/4"	48
484110	1/2"	5/16"	41
484810	1/2"	5/16"	48
484112	1/2"	3/8"	41
484314	1/2"	7/16"	43
484516	1/2"	1/2"	45
424110	1/2"	10mm	41
424312	1/2"	12mm	43
424514	1/2"	14mm	45



ITEM NO.	Drive	Hex Shank	Length mm
619+	3/4"	19mm	55
622+	3/4"	22mm	55
627+	3/4"	27mm	60

819+	1"	19mm	60
822+	1"	22mm	60
827+	1"	27mm	65
832+	1"	32mm	65

Screwdriver Bit Accessories



ITEM NO.	Hex Shank	Shank Length mm	Overall Length mm
520+2982	1/4"	22	72
520+2985	1/4"	50	100
520+2988	1/4"	85	135
520+2990	1/4"	200	250
*520+2983	1/4"	22	72



ITEM NO.	Hex Shank	Shank Length mm	Overall Length mm
524+2982	1/4"	22	162
*524+2983	1/4"	22	162
524+2985	1/4"	50	190
524+2988	1/4"	85	225
524+2990	1/4"	200	340



ITEM NO.	Hex Shank	Shank Length mm	Overall Length mm
522+2982	1/4"	22	87
*522+2983	1/4"	22	87
522+2985	1/4"	50	115



ITEM NO.	Hex Shank	Shank Length mm	Overall Length mm
*526+2983	1/4"	22	185
526+2985	1/4"	50	215
*526+2986	1/4"	50	215
526+2988	1/4"	85	250

Screwdriver Bit Accessories

OMNIDRIVE® 3 in 1 Handgrip

ITEM NO.	Hex Shank	Hex Shank	Hex Shank	Length mm
280120	1/4"	1/4"	5/16"	120

Be versatile. The OMNIDRIVE 3-in-1 Handgrip grants users the ability to interchange 5/16" hex shank drivers while all traditional screwdriver and T-handle

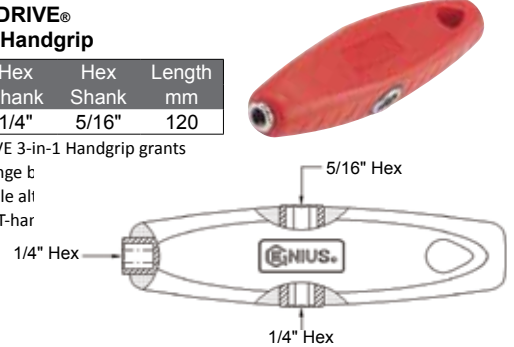

OMNIDRIVE® 4 in 1 Handgrip

ITEM NO.	Hex Shank	Hex Shank	Hex Shank	Square Drive	Length mm
280121M	1/4"	1/4"	5/16"	1/4"	120

Be versatile. The OMNIDRIVE 4-in-1 Handgrip grants users the ability to interchange bits with its 1/4" and 5/16" hex shank drivers and 1/4" square drive while alternating between traditional screwdriver and T-handle style grips.

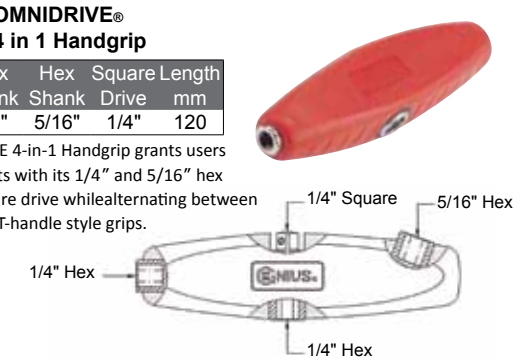

Flexible Extension

ITEM NO.	Male Drive	Female Drive	Length mm
282150	1/4"	1/4"	150

Flexible Bit Holder

ITEM NO.	Hex Shank	Female Drive	Length mm
282165	1/4"	1/4"	165

Flexible Bit Holders

ITEM NO.	Hex Shank	Hex Drive	Length mm
0260	1/4"	1/4"	180
0330	1/4"	1/4"	300

Flexible Bit Holder w/ Handle

ITEM NO.	Hex Shank	Shank Length mm	Overall mm
594+0260	1/4"	125	260

Flexible Extensions

ITEM NO.	Square Drive	Hex Drive	Length mm
0250	1/4"	1/4"	170
0350	1/4"	1/4"	300

Flexible Spinner w/ Handle

ITEM NO.	Square Drive	Shank Length mm	Overall mm
594+0250	1/4"	125	260

Magnetic Bit Holders

ITEM NO.	Hex Shank	Hex Drive	Length mm
0230	1/4"	1/4"	150
0233	1/4"	1/4"	250

Magnetic Bit Holder w/ Handle

ITEM NO.	Hex Shank	Shank Length mm	Overall mm
594+0230	1/4"	125	230

Bit Holder with Handle

ITEM NO.	Hex Shank	Length mm
280150	1/4"	150

Magnetic Stubby Bit Holder w/ Handle

ITEM NO.	Hex Shank	Length mm
280060	1/4"	60

Screwdriver Bit Accessories

Magnetic Bit Holder Adapters

ITEM NO.	Hex Shank	Hex Drive	Length mm
*286008	1/4"	1/4"	60
286008M	1/4"	1/4"	60

* direct fitting for electric and pneumatic impact wrenches

Magnetic Bit Holders w/ Quick Release

ITEM NO.	Hex Shank	Hex Drive	Length mm
*285708	1/4"	1/4"	60
285708M	1/4"	1/4"	60

* direct fitting for electric and pneumatic impact wrenches

Bit Holder Adapter

ITEM NO.	Hex Shank	Hex Drive	Length mm
285608	1/4"	1/4"	60

Socket Holder Adapter

ITEM NO.	Square Drive	Hex Drive	Length mm
280002B	1/4"	1/4"	30

Spinner Handles

ITEM NO.	Square Drive	Hex Drive	Length mm
272065	1/4"	1/4"	65
272140	1/4"	1/4"	140
273065	3/8"	1/4"	65
274065	1/2"	1/4"	65

Spinner Handles (for Electric Drill)

ITEM NO.	Square Drive	Hex Drive	Length mm
27206P	1/4"	1/4"	65
27306P	3/8"	1/4"	65
27406P	1/2"	1/4"	65

BE-2343 3pcs Spinner Handle Set

3 1/4 - 3/8 - 1/2" Dr. Spinner Handles

100g 180 Sets / 20 Kgs / 1.21 CUFT

BE-2343P* 3pcs Spinner Handle Set (for Electric Drill)

3 1/4 - 3/8 - 1/2" Dr. Spinner Handles (for Electric Drill)

100g 180 Sets / 20 Kgs / 1.21 CUFT

*also available for L1=9.5mm (BE-2343A)

Assorted Screwdriver Bit Sets

SB-111SP 11pcs Slotted & Philips Bit Set

- 6 Slotted (1130 ~ 1170) 30mmL
3 - 4 - 5 - 5.5 - 6 - 7mm
- 4 Philips (1100 ~ 1103) 30mmL
#0 - 1 - 2 - 3
- 1 Socket Holder Adapter (280002B)

100g 160 Sets / 17 Kgs / 0.71 CUFT

SB-211MH 11pcs Metric Hex & Triple Square Bit Set

- 8 Hex (2122 ~ 2136)
2 - 2.5 - 3 - 4 - 5 - 6 - 7 - 8mm (30mmL)
- 3 Triple Square (8104 ~ 8106)
M4 - 5 - 6 (30mmL)

100g 160 Sets / 17 Kgs / 0.71 CUFT

SB-311SH 11pcs SAE Hex Bit Set

- 11 Hex (3104 ~ 3116)
1/16 - 5/64 - 3/32 - 7/64 - 1/8 - 5/32 - 3/16 - 7/32 - 1/4 - 9/32 - 5/16" (30mmL)

100g 160 Sets / 17 Kgs / 0.71 CUFT

SB-711TP 11pcs Star Bit Set

- 11 Star (6106 ~ 6140)
T6 - 7 - 8 - 9 - 10 - 15 - 20 - 25 - 27 - 30 - 40 (30mmL)

100g 160 Sets / 17 Kgs / 0.71 CUFT

SB-811TP 11pcs Tamperproof Star Bit Set

- 11 Tamperproof Star (7107 ~ 7140)
T7 - 8 - 9 - 10 - 15 - 20 - 25 - 27 - 30 - 40 - 45 (30mmL)

100g 160 Sets / 17 Kgs / 0.71 CUFT

Assorted Screwdriver Bit Sets

SC-237M 37pcs Ratcheting Screwdriver & Bit Set

- 6 Slotted: 3 - 4 - 5 - 5.5 - 6 - 7mm (30mmL)
- 3 Philips: #1 - 2 - 3 (30mmL)
- 3 Posidriv #1 - 2 - 3 (30mmL)
- 6 Hex: 2 - 2.5 - 3 - 4 - 5 - 6mm (30mmL)
- 7 Star: T10 - 15 - 20 - 25 - 27 - 30 - 40 (30mmL)
- 7 Tamperproof Star: T10 - 15 - 20 - 25 - 27 - 30 - 40 (30mmL)
- 3 Triple Square: M4 - 5 - 6 (30mmL)
- 1 Socket Holder Adapter (280002B)
- 1 Ratcheting Screwdriver (524+2988)

650g 20 Sets / 14 Kgs / 1.5 CUFT

SC-234A 34pcs Ratcheting Screwdriver & Bit Set

- 6 Slotted: 4 - 5 - 5.5 - 6 - 6.5 - 7mm (30mmL)
- 3 Philips: #1 - 2 - 3 (30mmL)
- 6 Hex: 3/32 - 1/8 - 5/32 - 3/16 - 7/32 - 1/4" (30mmL)
- 7 Star: T10 - 15 - 20 - 25 - 27 - 30 - 40 (30mmL)
- 7 Tamperproof Star: T10 - 15 - 20 - 25 - 27 - 30 - 40 (30mmL)
- 3 Square: #1 - 2 - 3 (30mmL)
- 1 Socket Holder Adapter (280002B)
- 1 Ratcheting Screwdriver (524+2988)

700g 20 Sets / 15 Kgs / 1.5 CUFT

SB-252M 52pcs Metric Bits w/ OMNIDRIV® Set

- 1 OMNIDRIV® 4in1 Handgrip (280121X)
- 6 Slotted: 3 - 4 - 5 - 5.5 - 6 - 7mm (30mmL)
- 4 Philips: #0 - 1 - 2 - 3 (30mmL)
- 8 Hex: 2 - 2.5 - 3 - 4 - 5 - 6 - 7 - 8mm (30mmL)
- 11 Star: T6 - 7 - 8 - 9 - 10 - 15 - 20 - 25 - 27 - 30 - 40 (30mmL)
- 3 Triple Sq.: M4 - 5 - 6 (30mmL)
- 10 1/4" Dr. Socket (222503 ~ 222510)
3 - 4 - 4.5 - 5 - 5.5 - 6 - 7 - 8 - 9 - 10mm
- 9 Accessories: Socket Holder Adapter, Flexible Ext., Flexible Bit Holder, Magnetic Bit Holder 60&150mmL, Stubby Bit Holder, Extension Bar 100mmL, Wobble Ext. 50&150mmL

1250g 10 Sets / 13.5 Kgs / 0.82 CUFT

SB-276MS 76pcs Metric & SAE Complete Bits w/ OMNIDRIV® Set

- 1 OMNIDRIV® 4in1 Handgrip (280121X)
- 6 Slotted: 3 - 4 - 5 - 5.5 - 6 - 7mm (30mmL)
- 4 Philips: #0 - 1 - 2 - 3 (30mmL)
- 19 Hex: 2 - 2.5 - 3 - 4 - 5 - 6 - 7 - 8mm (30mmL)
Hex: 1/16 - 5/64 - 3/32 - 7/64 - 1/8 - 5/32 - 3/16 - 7/32 - 1/4 - 9/32 - 5/16" (30mmL)
- 11 Star: T6 - 7 - 8 - 9 - 10 - 15 - 20 - 25 - 27 - 30 - 40 (30mmL)
- 3 Triple Sq.: M4 - 5 - 6 (30mmL)
- 5 Sq.: #0 - 1 - 2 - 3 - 4 (30mmL)
- 18 1/4" Dr. Socket (222503 ~ 222510)
3 - 4 - 4.5 - 5 - 5.5 - 6 - 7 - 8 - 9 - 10mm
1/4" Dr. Socket (282504 ~ 282512)
1/8 - 3/16 - 7/32 - 1/4 - 9/32 - 5/16 - 11/32 - 3/8"
- 9 Accessories: Socket Holder Adapter, Flexible Ext., Flexible Bit Holder, Magnetic Bit Holder 60&150mmL, Stubby Bit Holder, Extension Bar 100mmL, Wobble Ext. 50&150mmL

1500g 10 Sets / 16 Kgs / 1.16 CUFT

Screwdriver Bits

Assorted Screwdriver Bit Sets

TX-246M 46pcs Metric Extra Long Complete Bits w/ OMNIDRIV® Set

- 1 OMNIDRIVE® 3in1 Handgrip (280120)
- 4 Slotted: 4 - 5 - 6 - 8mm (160mmL)
- 4 Philips: #1 - 2 - 3 - 4 (160mmL)
- 7 Hex: 2.5 - 3 - 4 - 5 - 6 - 7 - 8mm (160mmL)
- 13 Star: T6 - 7 - 8 - 9 - 10 - 15 - 20 - 25 - 27 - 30 - 40 - 45 - 50 (160mmL)
- 4 Triple Sq.: M4 - 5 - 6 - 8 (160mmL)
- 10 1/4" Dr. Socket (222504 ~ 222513) 4 - 5 - 6 - 7 - 8 - 9 - 10 - 11 - 12 - 13mm
- 3 1/4" Dr. Spinner Handle 65&140mmL - Universal Joint

2500g 4 Sets / 11 Kgs / 1.07 CUFT

TX-246S 46pcs SAE Extra Long Complete Bits w/ OMNIDRIV® Set

- 1 OMNIDRIVE® 3in1 Handgrip (280120)
- 4 Slotted: 4 - 5 - 6 - 8mm (160mmL)
- 4 Philips: #1 - 2 - 3 - 4 (160mmL)
- 7 Hex (3708 ~ 3720) 160mmL 1/8 - 5/32 - 3/16 - 7/32 - 1/4 - 9/32 - 5/16"
- 13 Star: T6 - 7 - 8 - 9 - 10 - 15 - 20 - 25 - 27 - 30 - 40 - 45 - 50 (160mmL)
- 4 Triple Sq.: M4 - 5 - 6 - 8 (160mmL)
- 10 1/4" Dr. Socket (282504 ~ 282516) 1/8 - 3/16 - 7/32 - 1/4 - 9/32 - 5/16 - 11/32 - 3/8 - 7/16 - 1/2"
- 3 1/4" Dr. Spinner Handle 65&140mmL - Universal Joint

2500g 4 Sets / 11 Kgs / 1.07 CUFT

TX-23475M 75pcs Metric Complete Bit Set

- 26 Hex: 2 - 2.5 - 3 - 4 - 5 - 6 - 7 - 8 - 9 - 10 - 11 - 12mm (30mmL)
- Hex: 2 - 2.5 - 3 - 4 - 5 - 6 - 7 - 8 - 9 - 10 - 11 - 12 - 13 - 14mm (88mmL)
- 14 Star: T6 - 7 - 8 - 9 - 10 - 15 - 20 - 25 - 27 - 30 - 40 - 45 - 50 - 55 (30mmL)
- 16 Tamperproof Star: T7 - 8 - 9 - 10 - 15 - 20 - 25 - 27 - 30 - 40 - 45 - 50 - 55 - 60 - 70 (88mmL)
- 14 Triple Square: M4 - 5 - 6 - 8 - 10 - 12 - 14 (30mmL)
- Triple Square: M4 - 5 - 6 - 8 - 10 - 12 - 14 (88mmL)
- 6 Bit Holders 1/4"Dr. x 1/4"Hex Shank - 3/8"Dr. x 5/16"Hex Shank - 1/2"Dr. x 5/16", 10mm, 12mm, 14mm Hex Shank

3000g 5 Sets / 16 Kgs / 1.21 CUFT

TX-23478S 78pcs SAE Complete Bit Set

- 26 Hex: 3/32 - 7/64 - 1/8 - 5/32 - 3/16 - 7/32 - 1/4 - 9/32 - 5/16 - 3/8 - 7/16 - 1/2" (30mmL)
- Hex: 1/16 - 5/64 - 3/32 - 7/64 - 1/8 - 5/32 - 3/16 - 7/32 - 1/4 - 9/32 - 5/16 - 3/8 - 7/16 - 1/2" (88mmL)
- 14 Star: T6 - 7 - 8 - 9 - 10 - 15 - 20 - 25 - 27 - 30 - 40 - 45 - 50 - 55 (30mmL)
- 16 Star: T7 - 8 - 9 - 10 - 15 - 20 - 25 - 27 - 30 - 40 - 45 - 50 - 55 - 60 - 70 (88mmL)
- 14 Triple Square: M4 - 5 - 6 - 8 - 10 - 12 - 14 (30mmL)
- Triple Square: M4 - 5 - 6 - 8 - 10 - 12 - 14 (88mmL)
- 9 Bit Holders 1/4"Dr. x 1/4"Hex Shank - 3/8"Dr. x 5/16"Hex Shank - 1/2"Dr. x 5/16", 3/8", 7/16", 1/2", 10mm, 12mm, 14mm Hex Shank

3300g 5 Sets / 17.5 Kgs / 1.21 CUFT

Screwdriver Bit Accessory Sets

GA-015A 15pcs 1/4" Hex Shank Ratcheting Screwdriver Accessory

- 2 Spinner Handle: 65 - 140mmL
- 1 Hex Adapter: 50mmL
- 3 Extensions: 88 - 160 - 250mmL
- 2 Magnetic Bit Holder: 150 - 250mmL
- 1 Magnetic Bit Holder: 60mmL
- 1 Flexible Bit Holder: 300mmL
- 1 Flexible Extension: 170mmL
- 1 Flexible Extension: 300mmL
- 1 Stubby Bit Holder: 60mmL
- 1 Ratcheting Screwdriver: 162mmL
- 1 T-Ratcheting Screwdriver: 72mmL

1600g 5 Sets / 9 Kgs / 1.01 CUFT

1/4" Hex Shank Reversible Blades

ITEM NO.	Size mm	Pattern A	Pattern B	Length mm
502046	0.8x4.0 - 1.2x6.5	⊕	⊖	180
502057	1.0x5.5 - 1.5x7.0	⊕	⊖	180
502114	PH.1 - 0.6x4.0	⊕	⊖	180
502126	PH.2 - 1.0x6.0	⊕	⊖	180
502137	PH.3 - 1.2x7.0	⊕	⊖	180
502201	PH.0 - PH.1	⊕	⊖	180
502212	PH.1 - PH.2	⊕	⊖	180
502223	PH.2 - PH.3	⊕	⊖	180
502311	PH.1 - PZ.1	⊕	⊖	180
502322	PH.2 - PZ.2	⊕	⊖	180
502401	PZ.0 - PZ.1	⊕	⊖	180
502412	PZ.1 - PZ.2	⊕	⊖	180
502423	PZ.2 - PZ.3	⊕	⊖	180
502515	T10 - T15	⊕	⊖	180
502525	T20 - T25	⊕	⊖	180
502540	T30 - T40	⊕	⊖	180
502625	2.5 - 2.5	⊕	⊖	180
502630	3.0 - 3.0	⊕	⊖	180
502640	4.0 - 4.0	⊕	⊖	180
502650	5.0 - 5.0	⊕	⊖	180
502660	6.0 - 6.0	⊕	⊖	180

RB-207W 7pcs Combination Reversible Blades Set

- 2 Philips / Slotted: #1 - 0.6x4.0mm (180mmL) #2 - 1.0x6.0mm (180mmL)
- 1 Posidriv: #1 - #2 (180mmL)
- 3 Star: T10 - T15, T20 - T25 T30 - T40 (180mmL)
- 1 1/4" Shank Grip Handle 110mmL

570g 20 Sets / 12.5 Kgs / 1.5 CUFT

RB-211W 11pcs Combination Reversible Blades Set

- 2 Slotted: 4.0 - 6.5mm, 5.5 - 7.0mm (180mmL)
- 1 Philips: #1 - #2 (180mmL)
- 1 Posidriv: #1 - #2 (180mmL)
- 3 Hex / Wobble: 4 - 4, 5 - 5, 6 - 6mm (180mmL)
- 3 Star: T10 - T15, T20 - T25 T30 - T40 (180mmL)
- 1 1/4" Shank Grip Handle 110mmL

840g 12 Sets / 11 Kgs / 1.16 CUFT

Impact Drivers & Sets

Impact Drivers

ITEM NO.	Drive	Length mm
700007	3/8"	135
700008	1/2"	138



ID-314 14pcs 3/8" Dr. Impact Driver Set

- 6 5/16" Hex Shank Slotted: 6.5 - 8.0 - 9.0mm (30mmL) 7.0 - 8.0 - 9.0mm (56mmL)
- 6 5/16" Hex Shank Philips: #2 - 3 - 4 (30mmL) #2 - 3 - 4 (56mmL)

- 1 3/8" Dr. 5/16" Hex Bit Holder
- 1 3/8" Dr. Impact Driver

1260g 15 Sets / 20 Kgs / 0.95 CUFT



ID-414 14pcs 1/2" Dr. Impact Driver Set

- 6 5/16" Hex Shank Slotted: 6.5 - 8.0 - 9.0mm (30mmL) 7.0 - 8.0 - 9.0mm (56mmL)
- 6 5/16" Hex Shank Philips: #2 - 3 - 4 (30mmL) #2 - 3 - 4 (56mmL)

- 1 1/2" Dr. 5/16" Hex Bit Holder
- 1 1/2" Dr. Impact Driver

1260g 15 Sets / 20 Kgs / 0.95 CUFT



TG-406B 6pcs 1/2" Dr. Impact Driver Set

- 2 5/16" Hex Shank Slotted: 1.2x8.0 - 1.6x10.0mm
- 2 5/16" Hex Shank Philips: #2 - 3

- 1 1/2" Dr. 5/16" Hex Bit Holder
- 1 1/2" Dr. Impact Driver

1070g 20 Sets / 22.5 Kgs / 0.64 CUFT



Torque Screwdrivers & Sets

Torque Screwdrivers

ITEM NO.	Drive	Capacity	Length mm
280005N	1/4"	1 ~ 5 Nm	150
280045L	1/4"	9 ~ 50 in.lbs.	150



TO-227N 27pcs Nm Torque Screwdriver Set

- 3 Slotted: 6 - 6.5 - 7mm (30mmL)
- 4 Hex: 3 - 4 - 5 - 6mm (30mmL)
- 7 Tamperproof Star: T10 - 15 - 20 - 25 - 27 - 30 - 40 (30mmL)
- 3 Triple Square: M4 - 5 - 6 (30mmL)
- 1 1/4" Dr. 1/4" Hex Shank Bit Holder
- 1 1/4" Dr. Torque Screwdriver 1 ~ 5 Nm

750g 15 Sets / 12.5 Kgs / 0.95 CUFT

TO-227L 27pcs in.lbs. Torque Screwdriver Set

- 3 Slotted: 6 - 6.5 - 7mm (30mmL)
- 4 Hex: 3 - 4 - 5 - 6mm (30mmL)
- 7 Tamperproof Star: T10 - 15 - 20 - 25 - 27 - 30 - 40 (30mmL)
- 3 Triple Square: M4 - 5 - 6 (30mmL)
- 1 1/4" Dr. 1/4" Hex Shank Bit Holder
- 1 1/4" Dr. Torque Screwdriver 9 ~ 50 in.lbs.

750g 15 Sets / 12.5 Kgs / 0.95 CUFT

TO-227N
(TO-227L)



Offset Screwdrivers

Offset Screwdrivers

ITEM NO.	Size	Length mm
560610	1.0 x 6	125
560812	1.2 x 8	150
560916	1.6 x 9	175
570012	#1 - 2	125
570034	#3 - 4	175



OS-505SP 5pcs Offset Screwdriver Set

- 3 Slotted Offset Screwdriver 1.0 x 6 - 1.2 x 8 - 1.6 x 9mm
- 2 Philips Offset Screwdriver #1 #2 - #3 x #4

370g 40 Sets / 16 Kgs / 0.71 CUFT



Tang-Thru Screwdrivers

Slotted Tang-Thru Screwdrivers

ITEM NO.	Size mm	Shank Length mm	Overall Length mm
509+1966	1.2x6.5	125	245
509+1990	1.6x10.0	185	305
509+1992	2.0x12.0	195	315
509+1994	2.5x14.0	245	365

Philips Tang-Thru Screwdrivers

ITEM NO.	Size	Shank Length mm	Overall Length mm
509+1801	#1	100	220
509+1812	#2	125	245
509+1843	#3	135	255
509+1924	#4	185	305

Posidriv Tang-Thru Screwdrivers

ITEM NO.	Size	Shank Length mm	Overall Length mm
509+1951	#1	100	220
509+1952	#2	125	245
509+1943	#3	160	270
509+1974	#4	210	320

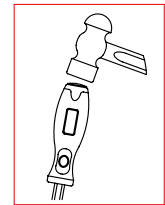

TT-508SP 8pcs Slotted & Philips Tang-Thru Screwdriver Set

- 4 Slotted: 6.5x245 - 10.0x305 - 12.0x315 - 14.0x365mmL
- 4 Philips: #1x220 - #2x245 - #3x255 - #4x305mmL

2850g 4 Sets / 12.5 Kgs / 1.07 CUFT



TT-512PZ 12pcs Combination Tang-Thru Screwdriver Set

- 4 Slotted: 6.5x245 - 10.0x305 - 12.0x315 - 14.0x365mmL
- 4 Philips: #1x220 - #2x245 - #3x255 - #4x305mmL
- 4 Posidriv: #1x220 - #2x245 - #3x270 - #4x320mmL

3750g 4 Sets / 16 Kgs / 1.65 CUFT



Screwdrivers

Screwdrivers w/ Rubber Handle

Slotted Screwdrivers

ITEM NO.	Size mm	Shank Length mm	Overall Length mm	Shank Type
504+0430	0.5x3.0	75	155	D
504+0440	0.5x4.0	100	180	D
504+1240	0.8x4.0	100	180	H
504+0550	0.8x5.0	250	330	D
506+1455	1.0x5.5	100	200	H
506+0560	1.0x6.0	150	250	D
506+1965	1.2x6.5	100	200	H
506+1966	1.2x6.5	150	250	H
506+0680	1.2x8.0	200	300	D
506+1980	1.2x8.0	180	280	H
508+1990	1.6x10.0	200	320	H
508+0890	1.6x10.0	250	370	D
508+1992	2.0x12.0	200	320	H
508+1994	2.5x14.0	250	370	H
502+1465	1.2x6.5	38	98	H

"D" for round shank, "H" for hex shank



Philips Screwdrivers

ITEM NO.	Size	Shank Length mm	Overall Length mm	Shank Type
504+0400	#0	75	155	D
504+1401	#1	90	170	H
504+1421	#1	120	200	H
504+0531	#1	250	330	D
506+0602	#2	75	175	D
506+1712	#2	100	200	H
506+1802	#2	125	225	H
506+0612	#2	150	250	D
506+1902	#2	200	300	H
506+0632	#2	300	400	D
508+1913	#3	125	245	H
508+1843	#3	150	270	H
508+1923	#3	200	320	H
508+0833	#3	270	390	D
508+1924	#4	200	320	H
502+1201	#1	38	98	H
502+1202	#2	38	98	H

"D" for round shank, "H" for hex shank



Posidriv Screwdrivers

ITEM NO.	Size mm	Shank Length mm	Overall Length mm	Shank Type
504+0450	#0	75	155	D
504+1741	#1	75	155	H
504+1841	#1	100	180	H
504+1951	#1	125	205	H
504+0561	#1	150	230	D
504+1971	#1	250	330	H
506+1842	#2	100	200	H
506+1952	#2	150	250	H
506+0662	#2	200	300	D
506+1972	#2	300	400	H
508+1943	#3	175	295	H
508+1974	#4	220	340	H
502+0501	#1	38	98	D
502+0502	#2	38	98	D

"D" for round shank, "H" for hex shank



Screwdrivers with plastic handle are also available. Please contact us for more details.

Screwdrivers w/ Rubber Handle

Star Screwdrivers

ITEM NO.	Size	Shank Length mm	Overall Length mm
504+6606	T6	70	150
504+6607	T7	70	150
504+6608	T8	70	150
504+6609	T9	70	150
506+6710	T10	85	185
506+6715	T15	85	185
506+6720	T20	85	185
506+6725	T25	85	185
506+6827	T27	125	225
506+6830	T30	125	225
508+6840	T40	115	235
508+6845	T45	115	235
508+6850	T50	115	235

Tamperproof Star Screwdrivers

ITEM NO.	Size	Shank Length mm	Overall Length mm
504+7606	T6	70	150
504+7607	T7	70	150
504+7608	T8	70	150
504+7609	T9	70	150
506+7710	T10	80	180
506+7715	T15	80	180
506+7920	T20	100	200
506+7925	T25	100	200
506+7827	T27	125	225
506+7830	T30	125	225
508+7940	T40	135	255
508+7945	T45	135	255
508+7850	T50	115	235

Metric Hex Screwdrivers

ITEM NO.	Size mm	Shank Length mm	Overall Length mm
504+2622	2	70	150
504+2625	2.5	70	150
504+2633	3	70	150
506+2634	4	70	170
506+2735	5	85	185
506+2736	6	85	185
508+2847	7	115	235
508+2848	8	115	235
508+2849	9	115	235
508+2850	10	115	235

SAE Hex Screwdrivers

ITEM NO.	Size Inch	Shank Length mm	Overall Length mm
504+3604	1/16	70	150
504+3605	5/64	70	150
504+3606	3/32	70	150
504+3607	7/64	70	150
504+3608	1/8	70	150
506+3610	5/32	70	170
506+3712	3/16	85	185
506+3714	7/32	85	185
506+3816	1/4	125	225
508+3818	9/32	115	235
508+3820	5/16	115	235
508+3824	3/8	115	235

Metric Wobble Hex Screwdrivers

ITEM NO.	Size mm	Shank Length mm	Overall Length mm
504+4633	3	70	150
506+4634	4	70	170
506+4735	5	85	185
506+4736	6	85	185
508+4847	7	115	235
508+4848	8	115	235
508+4849	9	115	235
508+4850	10	115	235

SAE Wobble Hex Screwdrivers

ITEM NO.	Size Inch	Shank Length mm	Overall Length mm
504+5608	1/8	70	150
506+5610	5/32	70	170
506+5712	3/16	85	185
506+5714	7/32	85	185
506+5816	1/4	125	225
508+5818	9/32	115	235
508+5820	5/16	115	235
508+5824	3/8	115	235

Square Screwdrivers

ITEM NO.	Size	Shank Length mm	Overall Length mm
506+9800	#0	125	225
506+9801	#1	125	225
508+9802	#2	125	245
508+9803	#3	125	245
508+9804	#4	125	245

Screwdriver Sets w/ Rubber Handle

TR-507S 7pcs Slotted & Philips Screwdriver Set

4 Slotted:
3.0x155 - 4.0x180 -
6.0x250 - 6.5x250mmL

3 Philips: #0x75 -
#1x200 - #2x225mmL



920g 5 Sets / 6 Kgs / 0.93 CUFT

TR-508Z 8pcs Combination Screwdriver Set

4 Slotted: 5.5x200 - 6.5x250 - 8.0x280 - 10.0x320mmL

2 Philips:
#1x200 - #2x225mmL

2 Posidriv:
#1x180 - #2x250mmL



1340g 10 Sets / 14.5 Kgs / 1.58 CUFT

TR-520PZ 20pcs Combination Screwdriver Set

6 Slotted:
3.0x155 - 4.0x180 -
6.0x250 - 6.5x250 -
10.0x320 - 6.5x98mmL

7 Philips:
#0x155 - #1x200 -
#1x330 - #2x175 - #2x250 -
#3x270 - #1x98mmL

7 Posidriv:
#0x155 - #1x180 -
#1x230 - #2x200 - #2x300 -
#3x295 - #1x98mmL



2600g 4 Sets / 11.5 Kgs / 1.65 CUFT

TR-513ST 13pcs Star Screwdriver Set

13 Star:
T6x150 - T7x150 - T8x150 -
T9x150 - T10x185 - T15x185 -
T20x185 - T25x185 - T27x225 -
T30x225 - T40x235 - T45x235 -
T50x235mmL

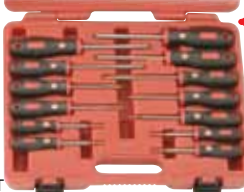

2250g 4 Sets / 10 Kgs / 1.65 CUFT

TR-510TA 10pcs Tamperproof Star Screwdriver Set

10 Tamperproof Star:
T8x150 - T10x180 -
T15x180 - T20x200 -
T25x200 - T27x225 -
T30x225 - T40x255 -
T45x255 - T50x235mmL



1480g 10 Sets / 16 Kgs / 1.58 CUFT

HR-5608M 8pcs Metric Hex Screwdriver Set

8 Metric Hex:
2x150 - 2.5x150 -
3x150 - 4x170 -
5x185 - 6x185 -
7x235 - 8x235mmL



1300g 10 Sets / 14 Kgs / 1.58 CUFT

HR-5611S 11pcs SAE Hex Screwdriver Set

11 SAE Hex: 1/16"x150 -
5/64"x150 - 3/32"x150 -
7/64"x150 - 1/8"x150 -
5/32"x170 - 3/16"x185 -
7/32"x185 - 1/4"x225 -
9/32"x235 - 5/16"x235mmL

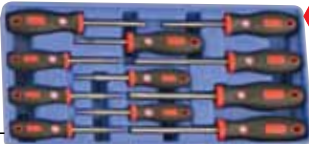

1500g 10 Sets / 16 Kgs / 1.58 CUFT

Screwdriver Sets w/ Rubber Handle

HR-578MW 8pcs Metric Wobble Hex Screwdriver Set

8 Metric Wobble Hex:
3x150 - 4x170 - 5x185 -
6x185 - 7x235 - 8x235 -
9x235 - 10x235mmL



1550g 10 Sets / 16.5 Kgs / 1.58 CUFT

HR-578SW 8pcs SAE Wobble Hex Screwdriver Set

8 SAE Wobble Hex:
1/8"x150 - 5/32"x170 -
3/16"x185 - 7/32"x185 -
1/4"x225 - 9/32"x235 -
5/16"x235 - 3/8"x235mmL



1450g 10 Sets / 15.5 Kgs / 1.58 CUFT

TR-504S 4pcs Square Screwdriver Set

4 Square:
#0x225 - #1x225 -
#2x245 - #3x245mmL



520g 24 Sets / 13.5 Kgs / 1.58 CUFT

Screwdriver Sets w/ Plastic Handle

TL-508X 8pcs Slotted & Philips Screwdriver Set

4 Slotted: 6.5x86 -
6.5x210 - 8.0x295 -
10.0x320mmL

4 Philips: #1x86 -
#1x185 - #2x235 -
#2x310mmL



1300g 10 Sets / 14 Kgs / 1.58 CUFT with large handle

TL-515X 15pcs Slotted, Philips Screwdriver & Pry Bar Set

6 Slotted: 3.0x170 - 5.0x360 -
6.5x210 - 8.0x295 -
10.0x320 - 6.5x86mmL

8 Philips: #0x170 - #1x185 -
#1x360 - #2x155 -
#2x235 - #2x310 -
#3x320 - #1x86mmL

1 Pry Bar: 300mmL (12")



2380g 4 Sets / 10.5 Kgs / 1.07 CUFT

TL-518 18pcs Slotted & Philips Screwdriver Set

5 Slotted: 5.0x345 -
6.5x195 - 10.0x310 -
10.0x360 - 6.5x86mmL

7 Philips: #1x170 - #1x345 -
#2x140 - #2x295 - #2x395 -
#3x310 - #1x86mmL

3 Micro-Tech Slotted:
2.0 - 2.5 - 3.0mm

3 Micro-Tech Philips:
#000 - #00 - #0





2360g 5 Sets / 13 Kgs / 1.58 CUFT

Screwdrivers



Nut Driver Sets

ND-012M 12pcs Metric Hex Nut Driver Set

12  Nut Driver
(593744 ~ 595764)
4 - 5 - 5.5 - 6 - 7 -
8 - 9 - 10 - 11 -
12 - 13 - 14mm



6 pt.



 1400g  6 Sets / 9.5 Kgs / 1.41 CUFT

ND-007S 7pcs SAE Hex Nut Driver Set

7  Nut Driver
(593712 ~ 595732)
3/16 - 1/4 - 5/16 - 11/32 -
3/8 - 7/16 - 1/2"



6 pt.



 1000g  6 Sets / 7 Kgs / 1.41 CUFT

ND-012MD 12pcs Metric Long Hex Nut Driver Set

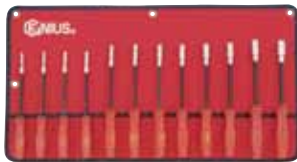
12  Long Nut Driver
(593844 ~ 595864)
4 - 5 - 5.5 - 6 - 7 -
8 - 9 - 10 - 11 - 12 -
13 - 14mm



6 pt.



 1720g  6 Sets / 11 Kgs / 1.41 CUFT

ND-007SD 7pcs SAE Long Hex Nut Driver Set

7  Long Nut Driver
(593812 ~ 595832)
3/16 - 1/4 - 5/16 - 11/32 -
3/8 - 7/16 - 1/2"



6 pt.

 1150g  6 Sets / 8 Kgs / 1.41 CUFT

1/4" Hex Shank Nut Drivers



6 pt.
Metric
Hex Nut Drivers



6 pt.
SAE
Hex Nut Drivers

ITEM NO.	Size mm	Hex Shank	Length mm
0444	4	1/4"	140
0445	5	1/4"	140
0455	5.5	1/4"	140
0456	6	1/4"	140
0457	7	1/4"	140
0458	8	1/4"	140
0459	9	1/4"	140
0460	10	1/4"	140
0461	11	1/4"	140
0462	12	1/4"	140
0463	13	1/4"	140
0464	14	1/4"	140

ITEM NO.	Size Inch	Hex Shank	Length mm
0512	3/16	1/4"	140
0516	1/4	1/4"	140
0520	5/16	1/4"	140
0522	11/32	1/4"	140
0524	3/8	1/4"	140
0528	7/16	1/4"	140
0532	1/2	1/4"	140

Micro-Tech Screwdriver Sets

TL-506A 6pcs Slotted & Phillips Micro-Tech Screwdriver Set

3  Slotted: 1.2 - 1.6 - 2.0mm
(122mmL)

3  Phillips:
#000 - #00 - #0
(122mmL)



+

 160g  40 Sets / 7.5 Kgs / 0.73 CUFT

MT-508L 8pcs Slotted & Phillips Micro-Tech Screwdriver Set

3  Slotted:
1.2 - 1.6 - 2.0 - 2.5 -
3.0mm (155mmL)

3  Phillips: #000 -
#00 - #0 (155mmL)



+

 200g  40 Sets / 9 Kgs / 0.73 CUFT

MT-5208 8pcs Star Micro-Tech Screwdriver Set

8  Star:
T5 - T6 - T7 - T8 -
T9 - T10 - T15 - T20
(155mmL)



 200g  40 Sets / 9 Kgs / 0.73 CUFT

MT-5306 6pcs Metric Hex Micro-Tech Screwdriver Set

6  Hex:
0.9 - 1.3 - 1.5mm
(122mmL)

Hex:
2.0 - 2.5 - 3.0mm
(155mmL)



+

 160g  40 Sets / 7.5 Kgs / 0.73 CUFT



MT-5405 5pcs SAE Hex Micro-Tech Screwdriver Set

5  SAE Hex:
1/20" - 1/16"
(122mmL)

SAE Hex:
5/64" - 3/32" - 7/64"
(155mmL)



+

 150g  40 Sets / 7 Kgs / 0.73 CUFT

NB-021M 21pcs Metric Hex Nut Driver & Bit Set

7  Hex Bits (2622 ~ 2648)
2.5 - 3 - 4 - 5 - 6 - 7 -
8mm (125mmL)

12  Nut Drivers (0444 ~ 0464)
4 - 5 - 5.5 - 6 - 7 - 8 - 9 -
10 - 11 - 12 - 13 - 14mm
(140mmL)

1  OMNIDRIVE® 3in1 Handgrip
1/4" & 5/16" Hex Shank (280120)

1  1/4" Hex Shank
Ratcheting Screwdriver
(524+2983) 162mmL





6 pt.

 1800g  5 Sets / 10 Kgs / 1.01 CUFT

ND-020MS 20pcs Metric & SAE Hex Nut Driver Set



12  Nut Drivers (0444 ~ 0464)
4 - 5 - 5.5 - 6 - 7 - 8 - 9 -
10 - 11 - 12 - 13 - 14mm
(140mmL)

7  Nut Drivers (0512 ~ 0532)
3/16 - 1/4 - 5/16 - 11/32 -
3/8 - 7/16 - 1/2" (140mmL)

1  1/4" Hex Shank
Ratcheting Screwdriver
(524+2983) 162mmL



6 pt.

 1800g  5 Sets / 10 Kgs / 1.01 CUFT

Air Ratchets

205051X 1/4" Dr. Stubby Air Ratchet

Specifications:

Air Pressure 90 psig / 620 kpa
 Max. Torque 20 ft.lb. / 27 Nm
 Free Speed 240 rpm
 Standard Bolt Cap 3/8 in. / 10 mm
 Overall Length 8 in. / 200 mm
 Avg. Air Consumption ... 2.5 cfm
 Air Inlet 1/4 in.
 Minimum Hose Size 3/8 in. / 10 mm
 1350g 20 pcs / 13.5 Kgs / 0.78 CUFT

20
FT.-LBS.



1/4

305052X 3/8" Dr. Heavy Duty Air Ratchet

Specifications:

Air Pressure 90 psig / 620 kpa
 Max. Torque 50 ft.lb. / 68 Nm
 Free Speed 160 rpm
 Standard Bolt Cap 3/8 in. / 10 mm
 Overall Length 10.2 in. / 260 mm
 Avg. Air Consumption ... 4.0 cfm
 Air Inlet 1/4 in.
 Minimum Hose Size 3/8 in. / 10 mm
 1200g 20 pcs / 25 Kgs / 0.78 CUFT

50
FT.-LBS.



3/8

405053X 1/2" Dr. Heavy Duty Air Ratchet

Specifications:

Air Pressure 90 psig / 620 kpa
 Max. Torque 50 ft.lb. / 68 Nm
 Free Speed 160 rpm
 Standard Bolt Cap 3/8 in. / 10 mm
 Overall Length 10.2 in. / 260 mm
 Avg. Air Consumption ... 4.0 cfm
 Air Inlet 1/4 in.
 Minimum Hose Size 3/8 in. / 10 mm
 1200g 20 pcs / 25 Kgs / 0.78 CUFT

50
FT.-LBS.



1/2

405054X 1/2" Dr. Super Duty Air Ratchet

Specifications:

Air Pressure 90 psig / 620 kpa
 Max. Torque 90 ft.lb. / 122 Nm
 Free Speed 150 rpm
 Standard Bolt Cap 3/8 in. / 10 mm
 Overall Length 14.2 in. / 360 mm
 Avg. Air Consumption ... 4.0 cfm
 Air Inlet 1/4 in.
 Minimum Hose Size 3/8 in. / 10 mm
 2000g 10 pcs / 21.5 Kgs / 0.57 CUFT

90
FT.-LBS.



1/2

Warning

- Wear proper eye protection
- Use only impact sockets and accessories
- Check the socket carefully for wear, cracks or damage before installation.

Caution

- Proper maintenance and usage practices will usually extend the tool's lifespan by two to three times.
- Do not attempt to drive or remove screws that will require more than five seconds of use by the unit at one time. This unit is not designed to remove damaged, rusted, or stubborn screws.
- Grease the motor everyday before use with 2-3 cc of R32 oil.
- Remember to pull the trigger for no longer than two seconds for the first time after oiling. Pulling the trigger for too long the first time after oiling will damage the unit and reduce its lifespan.
- Remember to grease the impact set every three to six months with 20-30 cc of R40 oil.

3/8" Dr. Air Impact Wrenches

300300G 3/8" Dr. Air Impact Wrench

Specifications:

Air Pressure 90 psig / 620 kpa
 Max. Torque 160 ft.lb. / 217 Nm
 Free Speed 9,500 rpm
 Standard Bolt Cap 1/2 in. / 13 mm
 Overall Length 5.9 in. / 150 mm
 Avg. Air Consumption ... 3.0 cfm
 Air Inlet 1/4 in.
 Minimum Hose Size 3/8 in. / 10 mm
 Machine Design **Pin Clutch**
 1350g 10 pcs / 16 Kgs / 0.65 CUFT

160
FT.-LBS.



3/8

300200 3/8" Dr. Super Duty Air Impact Wrench

Specifications:

Air Pressure 90 psig / 620 kpa
 Max. Torque 200 ft.lb. / 271 Nm
 Blows Per Min. 1,500
 Free Speed 10,000 rpm
 Standard Bolt Cap 7/16 in. / 11 mm
 Overall Length 5.5 in. / 140 mm
 Avg. Air Consumption ... 2.5 cfm
 Air Inlet 1/4 in.
 Minimum Hose Size 3/8 in. / 10 mm
 Machine Design **Jumbo Hammer**
 1350g 12 pcs / 19.5 Kgs / 1.24 CUFT

200
FT.-LBS.



3/8

300350 3/8" Dr. Super Duty Air Impact Wrench

Specifications:

Air Pressure 90 psig / 620 kpa
 Max. Torque 350 ft.lb. / 475 Nm
 Free Speed 11,000 rpm
 Standard Bolt Cap 9/16 in. / 14 mm
 Overall Length 5.6 in. / 142 mm
 Avg. Air Consumption ... 3.2 cfm
 Air Inlet 1/4 in.
 Minimum Hose Size 3/8 in. / 10 mm
 Machine Design **Twin Hammer**
 1600g 10 pcs / 17 Kgs / 0.7 CUFT

350
FT.-LBS.



3/8

3/8" Dr. Air Impact Wrench Sets

TF-316M1 16pcs 3/8" Dr. Metric Air Impact Wrench Kit

- 1 3/8" Dr. Air Impact Wrench
160 ft.lb. / 217 Nm (300300G)
 - 10 3/8" Dr. Impact Socket (313008 ~ 313021)
8 - 10 - 11 - 12 - 13 - 14 - 16 - 17 -
19 - 21mm
 - 1 3/8" Dr. Extension 75mmL (380029)
 - 1 4mm Hex Key Wrench (570740)
 - 1 Oil Pot (700180)
 - 1 1/4" Air Nipple (700183)
 - 1 1/4" Mini Oiler (700182)
- 3000g 6 Sets / 18.5 Kgs / 1.5 CUFT



TF-316S1 16pcs 3/8" Dr. SAE Air Impact Wrench Kit

- 1 3/8" Dr. Air Impact Wrench
160 ft.lb. / 217 Nm (300300G)
 - 10 3/8" Dr. Impact Socket (393010 ~ 393028)
5/16 - 3/8 - 7/16 - 1/2 - 9/16 - 5/8 -
11/16 - 3/4 - 13/16 - 7/8"
 - 1 3/8" Dr. Extension 75mmL (380029)
 - 1 4mm Hex Key Wrench (570740)
 - 1 Oil Pot (700180)
 - 1 1/4" Air Nipple (700183)
 - 1 1/4" Mini Oiler (700182)
- 3000g 6 Sets / 18.5 Kgs / 1.4 CUFT



Air Impact Wrenches

1/2" Dr. Air Impact Wrenches

400400G 1/2" Dr. Heavy Duty Air Impact Wrench

Specifications:
 Air Pressure 90 psig / 620 kpa
 Max. Torque 380 ft.lb. / 516 Nm
 Blows Per Min. 1,200
 Free Speed 7,000 rpm
 Standard Bolt Cap 9/16 in. / 14 mm
 Overall Length 7.5 in. / 190 mm
 Avg. Air Consumption ... 4.0 cfm
 Air Inlet 1/4 in.
 Minimum Hose Size 3/8 in. / 10 mm
 Machine Design **Pin Clutch**

2700g 2 pcs / 5.9 Kgs / 0.4 CUFT



400401 1/2" Dr. Super Duty Lightweight Mini Air Impact Wrench

Specifications:
 Air Pressure 90 psig / 620 kpa
 Max. Torque 400 ft.lb. / 542 Nm
 Free Speed 11,000 rpm
 Standard Bolt Cap 5/8 in. / 16 mm
 Overall Length 5.6 in. / 142 mm
 Avg. Air Consumption ... 3.2 cfm
 Air Inlet 1/4 in.
 Minimum Hose Size 3/8 in. / 10 mm
 Machine Design **Twin Hammer**

1600g 10 pcs / 17 Kgs / 0.7 CUFT



400402 1/2" Dr. Super Duty Long Anvil Lightweight Mini Air Impact Wrench

Specifications:
 Air Pressure 90 psig / 620 kpa
 Max. Torque 400 ft.lb. / 542 Nm
 Free Speed 11,000 rpm
 Standard Bolt Cap 5/8 in. / 16 mm
 Overall Length 7.6 in. / 192 mm
 Avg. Air Consumption ... 3.2 cfm
 Air Inlet 1/4 in.
 Minimum Hose Size 3/8 in. / 10 mm
 Machine Design **Twin Hammer**

1700g 10 pcs / 19 Kgs / 0.75 CUFT



400420 1/2" Dr. Super Duty Air Impact Wrench

Specifications:
 Air Pressure 90 psig / 620 kpa
 Max. Torque 420 ft.lb. / 570 Nm
 Blows Per Min. 1,200
 Free Speed 7,000 rpm
 Standard Bolt Cap 9/16 in. / 14 mm
 Overall Length 7.3 in. / 185 mm
 Avg. Air Consumption ... 4.2 cfm
 Air Inlet 1/4 in.
 Minimum Hose Size 3/8 in. / 10 mm
 Machine Design **Twin Hammer**

2700g 2 pcs / 6.5 Kgs / 0.4 CUFT



400422 1/2" Dr. Super Duty Long Anvil Air Impact Wrench

Specifications:
 Air Pressure 90 psig / 620 kpa
 Max. Torque 420 ft.lb. / 570 Nm
 Blows Per Min. 1,200
 Free Speed 7,000 rpm
 Standard Bolt Cap 9/16 in. / 14 mm
 Overall Length 9.3 in. / 235 mm
 Avg. Air Consumption ... 4.2 cfm
 Air Inlet 1/4 in.
 Minimum Hose Size 3/8 in. / 10 mm
 Machine Design **Twin Hammer**

2800g 2 pcs / 6.7 Kgs / 0.4 CUFT



400450 1/2" Dr. Super Duty Air Impact Wrench

Specifications:
 Air Pressure 90 psig / 620 kpa
 Max. Torque 450 ft.lb. / 610 Nm
 Free Speed 8,000 rpm
 Standard Bolt Cap 9/16 in. / 14 mm
 Overall Length 7.3 in. / 185 mm
 Avg. Air Consumption ... 4.5 cfm
 Air Inlet 1/4 in.
 Minimum Hose Size 3/8 in. / 10 mm
 Machine Design **Twin Hammer**

2700g 6 pcs / 17.8 Kgs / 0.7 CUFT



400452 1/2" Dr. Super Duty Long Anvil Air Impact Wrench

Specifications:
 Air Pressure 90 psig / 620 kpa
 Max. Torque 450 ft.lb. / 610 Nm
 Free Speed 8,000 rpm
 Standard Bolt Cap 9/16 in. / 14 mm
 Overall Length 9.3 in. / 235 mm
 Avg. Air Consumption ... 4.5 cfm
 Air Inlet 1/4 in.
 Minimum Hose Size 3/8 in. / 10 mm
 Machine Design **Twin Hammer**

2800g 6 pcs / 19 Kgs / 0.8 CUFT



400500 1/2" Dr. Super Duty Air Impact Wrench

Specifications:
 Air Pressure 90 psig / 620 kpa
 Max. Torque 500 ft.lb. / 678 Nm
 Blows Per Min. 1,300
 Free Speed 7,000 rpm
 Standard Bolt Cap 5/8 in. / 16 mm
 Overall Length 7.6 in. / 190 mm
 Avg. Air Consumption ... 5.4 cfm
 Air Inlet 1/4 in.
 Minimum Hose Size 3/8 in. / 10 mm
 Machine Design **Twin Hammer**

2900g 2 pcs / 6.8 Kgs / 0.4 CUFT



400502 1/2" Dr. Super Duty Long Anvil Air Impact Wrench

Specifications:
 Air Pressure 90 psig / 620 kpa
 Max. Torque 500 ft.lb. / 678 Nm
 Blows Per Min. 1,300
 Free Speed 7,000 rpm
 Standard Bolt Cap 5/8 in. / 16 mm
 Overall Length 9.6 in. / 245 mm
 Avg. Air Consumption ... 5.4 cfm
 Air Inlet 1/4 in.
 Minimum Hose Size 3/8 in. / 10 mm
 Machine Design **Twin Hammer**

3000g 2 pcs / 7 Kgs / 0.4 CUFT



400800 1/2" Dr. Ultra Duty Air Impact Wrench

Specifications:
 Air Pressure 90 psig / 620 kpa
 Max. Torque 800 ft.lb. / 1,085 Nm
 Free Speed 7,500 rpm
 Standard Bolt Cap 1-1/16 in. / 27 mm
 Overall Length 6.5 in. / 165 mm
 Avg. Air Consumption ... 4.5 cfm
 Air Inlet 1/4 in.
 Minimum Hose Size 3/8 in. / 10 mm
 Machine Design **Twin Hammer**

2500g 6 pcs / 17 Kgs / 0.7 CUFT



400802 1/2" Dr. Ultra Duty Long Anvil Air Impact Wrench

Specifications:
 Air Pressure 90 psig / 620 kpa
 Max. Torque 800 ft.lb. / 1,085 Nm
 Free Speed 7,500 rpm
 Standard Bolt Cap 1-1/16 in. / 27 mm
 Overall Length 8.5 in. / 215 mm
 Avg. Air Consumption ... 4.5 cfm
 Air Inlet 1/4 in.
 Minimum Hose Size 3/8 in. / 10 mm
 Machine Design **Twin Hammer**

2600g 6 pcs / 18 Kgs / 0.8 CUFT



4K0950 1/2" Dr. Ultra Duty Air Impact Wrench

Specifications:

Air Pressure 90 psig / 620 kpa
 Max. Torque 700 ft.lb. / 950 Nm
 Free Speed 8,000 rpm
 Overall Length 7.3 in. / 193 mm
 Avg. Air Consumption .. 4.4 cfm
 Air Inlet 1/4 in.
 Minimum Hose Size 3/8 in. / 10 mm
 Machine Design **Twin Hammer**

2100g 8 pcs / 19.5 Kgs / 1.3 CUFT



700
FT.-LBS.

1/2

NEW

4K0952 1/2" Dr. Ultra Duty Long Anvil Air Impact Wrench

Specifications:

Air Pressure 90 psig / 620 kpa
 Max. Torque 700 ft.lb. / 950 Nm
 Free Speed 8,000 rpm
 Overall Length 9.6 in. / 243 mm
 Avg. Air Consumption .. 4.4 cfm
 Air Inlet 1/4 in.
 Minimum Hose Size 3/8 in. / 10 mm
 Machine Design **Twin Hammer**

2200g 8 pcs / 21 Kgs / 1.8 CUFT



700
FT.-LBS.

1/2

NEW

400230 1/2" Dr. Super Duty Air Impact Wrench

Specifications:

Air Pressure 90 psig / 620 kpa
 Max. Torque 230 ft.lb. / 312 Nm
 Free Speed 7,000 rpm
 Standard Bolt Cap 5/8 in. / 16 mm
 Overall Length 7.3 in. / 185 mm
 Avg. Air Consumption ... 4.0 cfm
 Air Inlet 1/4 in.
 Minimum Hose Size 3/8 in. / 10 mm
 Machine Design **Rocking Dog Hammer**

2200g 10 pcs / 24.6 Kgs / 1.5 CUFT



230
FT.-LBS.

1/2

1/2" Dr. Air Impact Wrench Sets

TF-416K1 16pcs 1/2" Dr. Metric Air Impact Wrench Kit

- 1 1/2" Dr. Air Impact Wrench
230 ft.lb. / 312 Nm (400230)
- 10 1/2" Dr. Impact Socket (413809 ~ 413827)
9 - 10 - 11 - 13 - 14 - 17 - 19 - 22 -
24 - 27mm
- 1 1/2" Dr. Extension 125mmL (480036)
- 1 4mm Hex Key Wrench (570740)
- 1 Oil Pot (700180)
- 1 1/4" Air Nipple (700183)
- 1 1/4" Mini Oiler (700182)

4300g 4 Sets / 18 Kgs / 1.4 CUFT



TF-416S1 16pcs 1/2" Dr. SAE Air Impact Wrench Kit

- 1 1/2" Dr. Air Impact Wrench
230 ft.lb. / 312 Nm (400230)
- 10 1/2" Dr. Impact Socket (493814 ~ 493832)
7/16 - 1/2 - 9/16 - 5/8 - 11/16 - 3/4 -
13/16 - 7/8 - 15/16 - 1"
- 1 1/2" Dr. Extension 5"L (480036)
- 1 4mm Hex Key Wrench (570740)
- 1 Oil Pot (700180)
- 1 1/4" Air Nipple (700183)
- 1 1/4" Mini Oiler (700182)

4300g 4 Sets / 18 Kgs / 1.4 CUFT



GS-425K 27pcs 1/2" Dr. Metric Air Impact Wrench Set

- 1 1/2" Dr. Air Impact Wrench
230 ft.lb. / 312 Nm (400230)
- 17 1/2" Dr. Impact Socket
(444008 ~ 444030)
8 - 9 - 10 - 11 - 12 - 13 - 14 - 15 - 16 -
17 - 18 - 19 - 21 - 22 - 24 - 27 - 30mm
- 4 Adapter 3/8"Fx1/2"M (340040B) -
1/2"Fx3/8"M (480033MB) -
1/2"Fx3/4"M (480066MB) -
3/4"Fx1/2"M (640604B)
- 1 1/2" Dr. Ext. 75mmL (480032MB)
- 1 1/2" Dr. Sliding T-Handle (480040)
- 1 4mm Hex Key Wrench (570740)
- 1 Oil Pot (700180)
- 1 1/4" Air Nipple (700183)

7000g 2 Sets / 15.5 Kgs / 1.42 CUFT



3/4" Dr. Air Impact Wrenches

600750 3/4" Dr. Heavy Duty Air Impact Wrench

Specifications:

Air Pressure 90 psig / 620 kpa
 Max. Torque 750 ft.lb. / 1,016 Nm
 Blows Per Min. 1,000
 Free Speed 6,500 rpm
 Standard Bolt Cap 1 in. / 26 mm
 Overall Length 9 in. / 230 mm
 Avg. Air Consumption ... 7.0 cfm
 Air Inlet 1/4 in.
 Minimum Hose Size 3/8 in. / 10 mm
 Machine Design **Twin Hammer**

4550g 2 pcs / 10.5 Kgs / 0.7 CUFT



750
FT.-LBS.

3/4

600756 3/4" Dr. Heavy Duty Long Anvil Air Impact Wrench

Specifications:

Air Pressure 90 psig / 620 kpa
 Max. Torque 750 ft.lb. / 1,016 Nm
 Blows Per Min. 1,000
 Free Speed 6,500 rpm
 Standard Bolt Cap 1 in. / 26 mm
 Overall Length 15 in. / 380 mm
 Avg. Air Consumption ... 7.0 cfm
 Air Inlet 1/4 in.
 Minimum Hose Size 3/8 in. / 10 mm
 Machine Design **Twin Hammer**

5200g 2 pcs / 11.5 Kgs / 0.7 CUFT



750
FT.-LBS.

3/4

600850 3/4" Dr. Super Duty Lightweight Air Impact Wrench

Specifications:

Air Pressure 90 psig / 620 kpa
 Max. Torque 850 ft.lb. / 1,152 Nm
 Free Speed 7,500 rpm
 Standard Bolt Cap 1-1/8 in. / 29 mm
 Overall Length 6.7 in. / 170 mm
 Avg. Air Consumption ... 4.5 cfm
 Air Inlet 1/4 in.
 Minimum Hose Size 3/8 in. / 10 mm
 Machine Design **Twin Hammer**

2500g 6 pcs / 17 Kgs / 0.7 CUFT



850
FT.-LBS.

3/4

600856 3/4" Dr. Super Duty Long Anvil Lightweight Air Impact Wrench

Specifications:

Air Pressure 90 psig / 620 kpa
 Max. Torque 850 ft.lb. / 1,152 Nm
 Free Speed 7,500 rpm
 Standard Bolt Cap 1-1/8 in. / 29 mm
 Overall Length 12.8 in. / 325 mm
 Avg. Air Consumption ... 4.5 cfm
 Air Inlet 1/4 in.
 Minimum Hose Size 3/8 in. / 10 mm
 Machine Design **Twin Hammer**

3100g 6 pcs / 21 Kgs / 1.4 CUFT



850
FT.-LBS.

3/4

601100 3/4" Dr. Super Duty Air Impact Wrench

Specifications:

Air Pressure 90 psig / 620 kpa
 Max. Torque 1,100 ft.lb. / 1,491 Nm
 Free Speed 6,000 rpm
 Standard Bolt Cap 1-7/16 in. / 36 mm
 Overall Length 8.2 in. / 208 mm
 Avg. Air Consumption ... 6.0 cfm
 Air Inlet 1/4 in.
 Minimum Hose Size 3/8 in. / 10 mm
 Machine Design **Twin Hammer**

4100g 4 pcs / 18.6 Kgs / 0.85 CUFT



1100
FT.-LBS.

3/4

601106 3/4" Dr. Super Duty Long Anvil Air Impact Wrench

Specifications:

Air Pressure 90 psig / 620 kpa
 Max. Torque 1,100 ft.lb. / 1,491 Nm
 Free Speed 6,000 rpm
 Standard Bolt Cap 1-1/4 in. / 32 mm
 Overall Length 14.2 in. / 360 mm
 Avg. Air Consumption ... 6.0 cfm
 Air Inlet 1/4 in.
 Minimum Hose Size 3/8 in. / 10 mm
 Machine Design **Twin Hammer**

4700g 4 pcs / 21.5 Kgs / 1.3 CUFT



1100
FT.-LBS.

3/4

Air Impact Wrenches

1" Dr. Air Impact Wrenches

801200 1" Dr. Heavy Duty Lightweight Air Impact Wrench

Specifications:
 Air Pressure 90 psig / 620 kpa
 Max. Torque 1,200 ft.lb. / 1,627 Nm
 Free Speed 6,000 rpm
 Standard Bolt Cap 1-1/2 in. / 38 mm
 Overall Length 8.5 in. / 216 mm
 Avg. Air Consumption ... 6.0 cfm
 Air Inlet 1/4 in.
 Minimum Hose Size 3/8 in. / 10 mm
 Machine Design **Twin Hammer**

4200g 4 pcs / 19 Kgs / 0.85 CUFT



801206 1" Dr. Heavy Duty Long Anvil Lightweight Air Impact Wrench

Specifications:
 Air Pressure 90 psig / 620 kpa
 Max. Torque 1,200 ft.lb. / 1,627 Nm
 Free Speed 6,000 rpm
 Standard Bolt Cap 1-1/2 in. / 38 mm
 Overall Length 14.5 in. / 368 mm
 Avg. Air Consumption ... 6.0 cfm
 Air Inlet 1/4 in.
 Minimum Hose Size 3/8 in. / 10 mm
 Machine Design **Twin Hammer**

5100g 4 pcs / 23 Kgs / 1.30 CUFT



8K1630 1" Dr. Ultra Duty Air Impact Wrench

Specifications:
 Air Pressure 90 psig / 620 kpa
 Max. Torque 1,200 ft.lb. / 1,630 Nm
 Free Speed 5,500 rpm
 Overall Length 8.9 in. / 225 mm
 Avg. Air Consumption ... 9.5 cfm
 Air Inlet 3/8 in.
 Minimum Hose Size 1/2 in. / 12.7 mm
 Machine Design **Twin Hammer**

6100g 4 pcs / 26.5 Kgs / 1.24 CUFT



8K1636 1" Dr. Ultra Duty Long Anvil Air Impact Wrench

Specifications:
 Air Pressure 90 psig / 620 kpa
 Max. Torque 1,200 ft.lb. / 1,630 Nm
 Free Speed 5,500 rpm
 Overall Length 14 in. / 356 mm
 Avg. Air Consumption ... 9.5 cfm
 Air Inlet 3/8 in.
 Minimum Hose Size 1/2 in. / 12.7 mm
 Machine Design **Twin Hammer**

6800g 4 pcs / 30 Kgs / 1.50 CUFT



801800 1" Dr. Super Duty Air Impact Wrench

Specifications:
 Air Pressure 90 psig / 620 kpa
 Max. Torque 1,800 ft.lb. / 2,439 Nm
 Blows Per Min. 820
 Free Speed 4,000 rpm
 Standard Bolt Cap 1-1/4 in. / 32mm
 Overall Length 14.5 in. / 370 mm
 Avg. Air Consumption ... 13.2 cfm
 Air Inlet 1/2 in.
 Minimum Hose Size 3/4 in. / 19 mm
 Machine Design **Twin Hammer**

10.5 Kg 1 pc / 12.5 Kgs / 0.97 CUFT



801806 1" Dr. Super Duty Long Anvil Air Impact Wrench

Specifications:
 Air Pressure 90 psig / 620 kpa
 Max. Torque 1,800 ft.lb. / 2,439 Nm
 Blows Per Min. 820
 Free Speed 4,000 rpm
 Standard Bolt Cap 1-1/4 in. / 32 mm
 Overall Length 21.6 in. / 550 mm
 Avg. Air Consumption ... 13.2 cfm
 Air Inlet 1/2 in.
 Minimum Hose Size 3/4 in. / 19 mm
 Machine Design **Twin Hammer**

12 Kg 1 pc / 14 Kgs / 0.97 CUFT



8K3390 1" Dr. Ultra Duty Air Impact Wrench

Specifications:
 Air Pressure 90 psig / 620 kpa
 Max. Torque 2,500 ft.lb. / 3,390 Nm
 Free Speed 3,000 rpm
 Standard Bolt Cap 1-25/32 inch / 45 mm
 Overall Length 17 inch / 432 mm
 Avg. Air Consumption ... 14.5 cfm
 Air Inlet 1/2 in.
 Minimum Hose Size 3/4 in. / 19 mm
 Machine Design **Twin Hammer**

15.5 Kg 1 pc / 18 Kgs / 1.50 CUFT

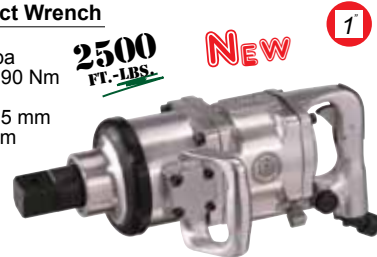

8K3398 1" Dr. Ultra Duty Long Anvil Air Impact Wrench

Specifications:
 Air Pressure 90 psig / 620 kpa
 Max. Torque 2,500 ft.lb. / 3,390 Nm
 Free Speed 3,000 rpm
 Standard Bolt Cap 1-25/32 inch / 45 mm
 Overall Length 24.8 inch / 630 mm
 Avg. Air Consumption ... 14.5 cfm
 Air Inlet 1/2 in.
 Minimum Hose Size 3/4 in. / 19 mm
 Machine Design **Twin Hammer**

17 Kg 1 pc / 19.5 Kgs / 1.50 CUFT



1-1/2" Dr. Air Impact Wrenches

9K3390 1-1/2" Dr. Ultra Duty Air Impact Wrench

Specifications:
 Air Pressure 90 psig / 620 kpa
 Max. Torque 2,500 ft.lb. / 3,390 Nm
 Free Speed 3,000 rpm
 Standard Bolt Cap 1-25/32 inch / 45 mm
 Overall Length 18 inch / 455 mm
 Avg. Air Consumption ... 14.5 cfm
 Air Inlet 1/2 in.
 Minimum Hose Size 3/4 in. / 19 mm
 Machine Design **Twin Hammer**

15.5 Kg 1 pc / 18 Kgs / 1.50 CUFT

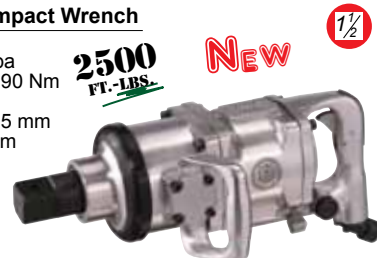

9K3398 1-1/2" Dr. Ultra Duty Long Anvil Air Impact Wrench

Specifications:
 Air Pressure 90 psig / 620 kpa
 Max. Torque 2,500 ft.lb. / 3,390 Nm
 Free Speed 3,000 rpm
 Standard Bolt Cap 1-25/32 inch / 45 mm
 Overall Length 24.8 inch / 630 mm
 Avg. Air Consumption ... 14.5 cfm
 Air Inlet 1/2 in.
 Minimum Hose Size 3/4 in. / 19 mm
 Machine Design **Twin Hammer**

17 Kg 1 pc / 19.5 Kgs / 1.50 CUFT



9K4070 1-1/2" Dr. Ultra Duty Air Impact Wrench

Specifications:
 Air Pressure 90 psig / 620 kpa
 Max. Torque 3,000 ft.lb. / 4,070 Nm
 Free Speed 3,000 rpm
 Standard Bolt Cap 2 inch / 50 mm
 Overall Length 18.5 inch / 470 mm
 Avg. Air Consumption ... 16 cfm
 Air Inlet 1/2 in.
 Minimum Hose Size 3/4 in. / 19 mm
 Machine Design **Twin Hammer**

17 Kg 1 pc / 19.5 Kgs / 1.50 CUFT

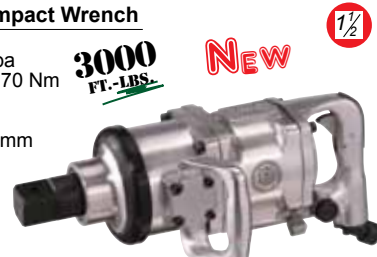

9K4078 1-1/2" Dr. Ultra Duty Long Anvil Air Impact Wrench

Specifications:
 Air Pressure 90 psig / 620 kpa
 Max. Torque 3,000 ft.lb. / 4,070 Nm
 Free Speed 3,000 rpm
 Standard Bolt Cap 2 inch / 50 mm
 Overall Length 24.4 inch / 620 mm
 Avg. Air Consumption ... 16 cfm
 Air Inlet 1/2 in.
 Minimum Hose Size 3/4 in. / 19 mm
 Machine Design **Twin Hammer**

22.8 Kg 1 pc / 25.3 Kgs / 1.50 CUFT



Combination Wrenches

**Metric
Combination Wrenches
- Mirror Finish**

ITEM NO.	Size mm	Length mm
748206	6	130
748207	7	135
748208	8	142
748209	9	154
748210	10	162
748211	11	170
748212	12	175
748213	13	180
748214	14	195
748215	15	205
748216	16	205
748217	17	228
748218	18	228
748219	19	250
748220	20	250
748221	21	270
748222	22	295
748223	23	295
748224	24	315
748225	25	338
748226	26	338
748227	27	360
748228	28	360
748229	29	395
748230	30	395
748232	32	430

**SAE
Combination Wrenches
- Mirror Finish**

ITEM NO.	Size Inch	Length mm
759208	1/4	130
759210	5/16	142
759212	3/8	154
759214	7/16	170
759216	1/2	180
759218	9/16	195
759220	5/8	205
759222	11/16	228
759224	3/4	250
759226	13/16	270
759228	7/8	295
759230	15/16	315
759232	1	338
759234	1-1/16	360
759236	1-1/8	395
759240	1-1/4	430

Combination Wrench Sets - Mirror Finish

PR-011S 11pcs SAE Combination Wrench Set

11 SAE Combination
(759210 ~ 759232)
5/16 - 3/8 - 7/16 - 1/2 -
9/16 - 5/8 - 11/16 - 3/4 -
7/8 - 15/16 - 1"



2300g 6 Sets / 15.5 Kgs / 0.65 CUFT



PR-016S 16pcs SAE Combination Wrench Set

16 SAE Combination
(759208 ~ 759240)
1/4 - 5/16 - 3/8 - 7/16 - 1/2 -
9/16 - 5/8 - 11/16 - 3/4 -
13/16 - 7/8 - 15/16 - 1" -
1 1/16 - 1 1/8 - 1 1/4"



5000g 4 Sets / 21 Kgs / 0.74 CUFT



Combination Wrenches - Matt Finish

**Metric
Combination Wrenches
- Matt Finish**

ITEM NO.	Size mm	Length mm
726006	6	102
726007	7	107
726008	8	112
726009	9	123
726010	10	140
726011	11	150
726012	12	158
726013	13	171
726014	14	186
726015	15	198
726016	16	204
726017	17	224
726018	18	224
726019	19	248
726020	20	277
726021	21	277
726022	22	295
726023	23	295
726024	24	320
726025	25	342
726026	26	342
726027	27	370
726030	30	410
726032	32	430
726033	33	461
726034	34	461
726035	35	461
726036	36	486
726038	38	486
726040	40	540
726041	41	540
726042	42	540
726045	45	611
726046	46	611
726050	50	611
726055	55	666
726060	60	760
726065	65	760

**SAE
Combination Wrenches
- Matt Finish**

ITEM NO.	Size Inch	Length mm
737008	1/4	102
737010	5/16	112
737012	3/8	140
737014	7/16	150
737016	1/2	171
737018	9/16	186
737020	5/8	206
737022	11/16	224
737024	3/4	248
737026	13/16	277
737028	7/8	295
737030	15/16	320
737032	1	342
737034	1-1/16	370
737036	1-1/8	393
737040	1-1/4	430
737042	1-5/16	461
737044	1-3/8	461
737046	1-7/16	486
737048	1-1/2	486
737052	1-5/8	540
737054	1-11/16	540
737056	1-3/4	611
737058	1-13/16	611
737060	1-7/8	611
737064	2	611
737068	2-1/8	665
737072	2-1/4	665
737076	2-3/8	760
737080	2-1/2	760

Combination Wrench Sets - Mirror Finish

PR-015M 15pcs Metric Combination Wrench Set

15 Metric Combination
(748207 ~ 748224)
7 - 8 - 9 - 10 - 11 - 12 -
13 - 14 - 15 - 16 - 17 -
18 - 19 - 22 - 24mm



1/3 Tray 2500g 10 Sets / 26.5 Kgs / 1.58 CUFT



PR-017M 17pcs Metric Combination Wrench Set

17 Metric Combination
(748206 ~ 748222)
6 - 7 - 8 - 9 - 10 -
11 - 12 - 13 - 14 - 15 -
16 - 17 - 18 - 19 - 20 -
21 - 22mm



2500g 8 Sets / 22 Kgs / 0.82 CUFT



PR-026M 26pcs Metric Combination Wrench Set

26 Metric Combination
(748206 ~ 748232)
6 - 7 - 8 - 9 - 10 - 11 -
12 - 13 - 14 - 15 - 16 -
17 - 18 - 19 - 20 - 21 -
22 - 23 - 24 - 25 - 26 -
27 - 28 - 29 - 30 - 32mm



8000g 2 Sets / 17 Kgs / 0.6 CUFT



PR-009S 9pcs SAE Combination Wrench Set

9 SAE Combination
(759210 ~ 759232)
5/16 - 3/8 - 7/16 -
1/2 - 9/16 - 5/8 -
3/4 - 7/8 - 1"



1750g 12 Sets / 22 Kgs / 0.93 CUFT



Wrenches

Combination Wrench Sets - Matt Finish

HS-011M 11pcs Metric Combination Wrench Set

11 Metric Combination (726007 ~ 726019)
 7 - 8 - 9 - 10 -
 11 - 12 - 13 - 14 -
 15 - 17 - 19mm



Plastic Hook 1150g 12 Sets / 16 Kgs / 1.38 CUFT

HS-013M 13pcs Metric Combination Wrench Set

13 Metric Combination (726006 ~ 726024)
 6 - 7 - 8 - 9 - 10 -
 11 - 12 - 13 - 14 -
 17 - 19 - 22 - 24mm



1900g 6 Sets / 12.5 Kgs / 0.65 CUFT

HS-016M 16pcs Metric Combination Wrench Set

16 Metric Combination (726006 ~ 726032)
 6 - 7 - 8 - 9 - 10 -
 11 - 12 - 13 - 14 -
 17 - 19 - 22 - 24 -
 27 - 30 - 32mm



4500g 4 Sets / 19 Kgs / 0.82 CUFT

HS-024M 24pcs Metric Combination Wrench Set

24 Metric Combination (726006 ~ 726032)
 6 - 7 - 8 - 9 - 10 -
 11 - 12 - 13 - 14 -
 15 - 16 - 17 - 18 -
 19 - 20 - 21 - 22 -
 23 - 24 - 25 - 26 -
 27 - 30 - 32mm



6000g 4 Sets / 27.5 Kgs / 1.19 CUFT

HS-009S 9pcs SAE Combination Wrench Set

9 SAE Combination (737010 ~ 737032)
 5/16 - 3/8 - 7/16 -
 1/2 - 9/16 - 5/8 -
 3/4 - 7/8 - 1"



1750g 8 Sets / 15 Kgs / 0.71 CUFT

HS-011S 11pcs SAE Combination Wrench Set

11 SAE Combination (737008 ~ 737028)
 1/4 - 5/16 - 3/8 - 7/16 -
 1/2 - 9/16 - 5/8 - 11/16 -
 3/4 - 13/16 - 7/8"



Plastic Hook 1700g 12 Sets / 22 Kgs / 1.22 CUFT

HS-016S 16pcs SAE Combination Wrench Set

16 SAE Combination (737008 ~ 737040)
 1/4 - 5/16 - 3/8 - 7/16 - 1/2 -
 9/16 - 5/8 - 11/16 - 3/4 -
 13/16 - 7/8 - 15/16 - 1" -
 1 1/16 - 1 1/8 - 1 1/4"



4500g 4 Sets / 21 Kgs / 0.89 CUFT

Offset Box End Wrenches - Mirror Finish

Metric Offset Box Wrenches - Mirror Finish

ITEM NO.	Size mm	Length mm
740607	6 x 7	167
740809	8 x 9	182
741011	10 x 11	197
741213	12 x 13	218
741415	14 x 15	238
741617	16 x 17	258
741819	18 x 19	290
742022	20 x 22	316
742123	21 x 23	316
742426	24 x 26	328
742528	25 x 28	345
742729	27 x 29	353
743032	30 x 32	360

SAE Offset Box Wrenches - Mirror Finish

ITEM NO.	Size Inch	Length mm
750810	1/4 x 5/16	167
751214	3/8 x 7/16	200
751618	1/2 x 9/16	238
752022	5/8 x 11/16	258
752426	3/4 x 13/16	296
752830	7/8 x 15/16	315
753234	1 x 1-1/16	345
753640	1-1/8 x 1-1/4	360

Offset Box End Wrench Sets - Mirror Finish

DE-707M 7pcs Metric Offset Box End Wrench Set

7 Metric Offset Box End Wrench (740607 ~ 741819)
 6x7 - 8x9 - 10x11 -
 12x13 - 14x15 -
 16x17 - 18x19mm



1/3 Tray 1340g 10 Sets / 14.5 Kgs / 1.58 CUFT

DE-708M 8pcs Metric Offset Box End Wrench Set

8 Metric Offset Box End Wrench (740607 ~ 742022)
 6x7 - 8x9 - 10x11 -
 12x13 - 14x15 - 16x17 -
 18x19 - 20x22mm



1650g 9 Sets / 16 Kgs / 1.65 CUFT

DE-713M 13pcs Metric Offset Box End Wrench Set

13 Metric Offset Box End Wrench (740607 ~ 743032)
 6x7 - 8x9 - 10x11 - 12x13 -
 14x15 - 16x17 - 18x19 -
 20x22 - 21x23 - 24x26 -
 25x28 - 27x29 - 30x32mm



4570g 6 Sets / 28.5 Kgs / 1.65 CUFT

DE-706S 6pcs SAE Offset Box End Wrench Set

6 SAE Offset Box End Wrench (750810 ~ 752830)
 1/4x5/16 - 3/8x7/16 -
 1/2x9/16 - 5/8x11/16 -
 3/4x13/16 - 7/8x15/16"



1440g 9 Sets / 14 Kgs / 1.16 CUFT

DE-708S 8pcs SAE Offset Box End Wrench Set

8 SAE Offset Box End Wrench (750810 ~ 753640)
 1/4x5/16 - 3/8x7/16 -
 1/2x9/16 - 5/8x11/16 -
 3/4x13/16 - 7/8x15/16 -
 1"x1 1/16 - 1 1/8x1 1/4"



2680g 9 Sets / 25 Kgs / 1.65 CUFT

Offset Box End Wrenches - Matt Finish

**Metric
Offset Box Wrenches
- Matt Finish**

ITEM NO.	Size mm	Length mm
740607	6 x 7	165
740809	8 x 9	180
741011	10 x 11	200
741213	12 x 13	220
741415	14 x 15	240
741617	16 x 17	260
741819	18 x 19	290
742022	20 x 22	315
742123	21 x 23	330
742426	24 x 26	345
742528	25 x 28	355
742729	27 x 29	355
743032	30 x 32	370

**SAE
Offset Box Wrenches
- Matt Finish**

ITEM NO.	Size Inch	Length mm
750810	1/4 x 5/16	165
751214	3/8 x 7/16	200
751618	1/2 x 9/16	220
752022	5/8 x 11/16	260
752426	3/4 x 13/16	315
752830	7/8 x 15/16	330
753234	1 x 1-1/16	355
753640	1-1/8 x 1-1/4	370

Offset Box End Wrench Sets - Matt Finish

DE-7208M 8pcs Metric Offset Box End Wrench Set

8 Metric Offset Box End Wrench (720607 ~ 722022)
6x7 - 8x9 - 10x11 - 12x13 - 14x15 - 16x17 - 18x19 - 20x22mm

1630g 9 Sets / 16 Kgs / 1.65 CUFT

DE-7213M 13pcs Metric Offset Box End Wrench Set

13 Metric Offset Box End Wrench (720607 ~ 723032)
6x7 - 8x9 - 10x11 - 12x13 - 14x15 - 16x17 - 18x19 - 20x22 - 21x23 - 24x26 - 25x28 - 27x29 - 30x32mm

4400g 6 Sets / 27 Kgs / 1.65 CUFT

DE-7106S 6pcs SAE Offset Box End Wrench Set

6 SAE Offset Box End Wrench (710810 ~ 712830)
1/4x5/16 - 3/8x7/16 - 1/2x9/16 - 5/8x11/16 - 3/4x13/16 - 7/8x15/16"

1470g 9 Sets / 14.5 Kgs / 1.16 CUFT

DE-7108S 8pcs SAE Offset Box End Wrench Set

8 SAE Offset Box End Wrench (710810 ~ 713640)
1/4x5/16 - 3/8x7/16 - 1/2x9/16 - 5/8x11/16 - 3/4x13/16 - 7/8x15/16 - 1"x1 1/16 - 1 1/8x1 1/4"

2900g 9 Sets / 27.5 Kgs / 1.65 CUFT

Extra Long Box End Wrenches

**Metric
Extra Long Box Wrenches
- Mirror Finish**

ITEM NO.	Size mm	Length mm
780810L	8 x 10	235
781012L	10 x 12	292
781214L	12 x 14	330
781315L	13 x 15	330
781417L	14 x 17	369
781618L	16 x 18	407
781719L	17 x 19	407
782224L	22 x 24	435

**SAE
Extra Long Box Wrenches
- Mirror Finish**

ITEM NO.	Size Inch	Length mm
791012L	5/16 x 3/8	235
791416L	7/16 x 1/2	292
791820L	9/16 x 5/8	369
792224L	11/16 x 3/4	407

DE-706M 6pcs Metric Extra Long Box End Wrench Set

6 Metric Extra Long Box End Wrench (781012L ~ 781719L)
10x12 (292mmL) - 12x14 (330mmL) - 13x15 (330mmL) - 14x17 (369mmL) - 16x18 (407mmL) - 17x19 (407mmL)

1440g 12 Sets / 18.5 Kgs / 0.69 CUFT

DE-704S 4pcs SAE Extra Long Box End Wrench Set

4 SAE Extra Long Box End Wrench (791012L ~ 792224L)
5/16x3/8 (235mmL) - 7/16x1/2 (292mmL) - 9/16x5/8 (369mmL) - 11/16x3/4 (407mmL)

890g 12 Sets / 11.5 Kgs / 0.69 CUFT

E-Star Wrenches

E-Star Wrenches - Mirror Finish

ITEM NO.	Size	Length mm
790608	E-6 x E-8	112
791012	E-10 x E-12	141
791418	E-14 x E-18	181
792024	E-20 x E-24	225



TX-E04 4pcs E-Star Wrench Set

4 E-Star (790608 ~ 792024)
E6xE8 - E10xE12 - E14xE18 - E20xE24

400g 20 Sets / 9 Kgs / 0.6 CUFT

TX-2324 24pcs Star Wrench Set

4 E-Star (790608 ~ 792024)
E6xE8 - E10xE12 - E14xE18 - E20xE24

7 3/8" Dr. E-Star Socket (353510 ~ 20)
E10 - 11 - 12 - 14 - 16 - 18 - 20

10 Tamperproof Star Bit (7108 ~ 7150)
T8 - 10 - 15 - 20 - 25 - 27 - 30 - 40 - 45 - 50 (30mmL)

3 Bit Holder 1/4"Dr.x1/4" (262808) - 3/8"Dr.x1/4" (363008) - 3/8"Dr.x5/16" (363010)

980g 10 Sets / 11 Kgs / 0.93 CUFT

Wrenches

Combination Ratcheting Wrenches

Metric Combination Ratcheting Wrenches - Mirror Finish

ITEM NO.	Size mm	Length mm
768508	8	136
768510	10	160
768511	11	168
768512	12	174
768513	13	180
768514	14	193
768515	15	200
768516	16	216
768517	17	233
768518	18	239
768519	19	250
768521	21	285
768522	22	285
768523	23	285
768524	24	325
768525	25	325
768526	26	325
768527	27	355
768528	28	355
768530	30	425
768532	32	425

SAE Combination Ratcheting Wrenches - Mirror Finish

ITEM NO.	Size Inch	Length mm
778510	5/16	136
778512	3/8	160
778514	7/16	168
778516	1/2	180
778518	9/16	193
778520	5/8	216
778522	11/16	233
778524	3/4	250
778526	13/16	285
778528	7/8	285
778530	15/16	325
778532	1	325
778534	1-1/16	355
778536	1-1/8	425
778540	1-1/4	425

Combination Ratcheting Wrench Sets

GW-7611M 11pcs Metric Combination Ratcheting Wrench Set

11 Metric Combination Ratcheting Wrench (768508 ~ 768519)
8 - 10 - 11 - 12 - 13 - 14 - 15 - 16 - 17 - 18 - 19mm



1690g 8 Sets / 14.5 Kgs / 0.7 CUFT

GW-7617M 17pcs Metric Combination Ratcheting Wrench Set

17 Metric Combination Ratcheting Wrench (768508 ~ 768532)
8 - 10 - 11 - 12 - 13 - 14 - 15 - 16 - 17 - 18 - 19 - 21 - 22 - 24 - 27 - 30 - 32mm



6330g 3 Sets / 20.5 Kgs / 1.68 CUFT

GW-7708S 8pcs SAE Combination Ratcheting Wrench Set

8 SAE Combination Ratcheting Wrench (778510 ~ 778524)
5/16 - 3/8 - 7/16 - 1/2 - 9/16 - 5/8 - 11/16 - 3/4"



1190g 8 Sets / 10.5 Kgs / 0.7 CUFT

GW-7715S 15pcs SAE Combination Ratcheting Wrench Set

15 SAE Combination Ratcheting Wrench (778510 ~ 778540)
5/16 - 3/8 - 7/16 - 1/2 - 9/16 - 5/8 - 11/16 - 3/4 - 13/16 - 7/8 - 15/16 - 1" - 1 1/16 - 1 1/8 - 1 1/4"



6380g 3 Sets / 20.5 Kgs / 1.68 CUFT

Stubby Combination Ratcheting Wrenches

Metric Stubby Combination Ratcheting Wrenches - Mirror Finish

ITEM NO.	Size mm	Length mm
760210	10	96
760211	11	100
760212	12	104
760213	13	108
760214	14	114
760215	15	118
760216	16	122
760217	17	128
760218	18	132
760219	19	138

SAE Stubby Combination Ratcheting Wrenches - Mirror Finish

ITEM NO.	Size Inch	Length mm
770212	3/8	96
770214	7/16	100
770216	1/2	108
770218	9/16	114
770220	5/8	122
770222	11/16	128
770224	3/4	138

Stubby Combination Ratcheting Wrench Sets

GW-7610M 10pcs Metric Stubby Combination Ratcheting Wrench

10 Metric Combination Ratcheting Wrench (760210 ~ 760219)
10 - 11 - 12 - 13 - 14 - 15 - 16 - 17 - 18 - 19mm



1130g 8 Sets / 10 Kgs / 0.7 CUFT

GW-7707S 7pcs SAE Stubby Combination Ratcheting Wrench Set

7 SAE Combination Ratcheting Wrench (770212 ~ 770224)
3/8 - 7/16 - 1/2 - 9/16 - 5/8 - 11/16 - 3/4"



820g 8 Sets / 7.5 Kgs / 0.7 CUFT

Flare Nut Wrenches

Metric Flare Nut Wrenches - Mirror Finish

ITEM NO.	Size mm	Length mm
740911	9 x 11	127
741012	10 x 12	141
741314	13 x 14	157
741517	15 x 17	173
741618	16 x 18	181
741921	19 x 21	194

SAE Flare Nut Wrenches - Mirror Finish

ITEM NO.	Size Inch	Length mm
760810	1/4 x 5/16	105
761214	3/8 x 7/16	133
761618	1/2 x 9/16	157
762022	5/8 x 11/16	181
762428	3/4 x 7/8	193

FN-006M 6pcs Metric Flare Nut Wrench Set

6 Metric Flare Nut Wrench (740911 ~ 741921)
9x11 - 10x12 - 13x14 - 15x17 - 16x18 - 19x21mm



840g 12 Sets / 11 Kgs / 0.63 CUFT

FN-005S 5pcs SAE Flare Nut Wrench Set

5 SAE Flare Nut Wrench (760810 ~ 762428)
1/4x5/16 - 3/8x7/16 - 1/2x9/16 - 5/8x11/16 - 3/4x7/8"



670g 12 Sets / 9 Kgs / 0.63 CUFT

Open End Wrenches

Metric Open End Wrenches - Matt Finish

ITEM NO.	Size mm	Length mm
790607	6 x 7	122
790809	8 x 9	140
791011	10 x 11	156
791213	12 x 13	172
791415	14 x 15	188
791617	16 x 17	204
791819	18 x 19	220
792022	20 x 22	234
792123	21 x 23	247
792426	24 x 26	266
792528	25 x 28	285
792730	27 x 30	302
793032	30 x 32	302

SAE Open End Wrenches - Matt Finish

ITEM NO.	Size Inch	Length mm
770810	1/4 x 5/16	122
771214	3/8 x 7/16	156
771618	1/2 x 9/16	180
772022	5/8 x 11/16	204
772428	3/4 x 7/8	234
772628	13/16 x 7/8	247
773032	15/16 x 1	266
773236	1 x 1-1/8	285
773440	1-1/16 x 1-1/4	302

Open End Wrench Sets

OW-708M 8pcs Metric Open End Wrench Set

8 Metric Open End Wrench (790607 ~ 792022)
6x7 - 8x9 - 10x11 - 12x13 - 14x15 - 16x17 - 18x19 - 20x22mm



15°

920g 10 Sets / 10.5 Kgs / 0.62 CUFT

OW-713M 13pcs Metric Open End Wrench Set

13 Metric Open End Wrench (790607 ~ 793032)
6x7 - 8x9 - 10x11 - 12x13 - 14x15 - 16x17 - 18x19 - 20x22 - 21x23 - 24x26 - 25x28 - 27x30 - 30x32mm



15°

3000g 4 Sets / 13.5 Kgs / 0.82 CUFT

OW-706S 6pcs SAE Open End Wrench Set

6 SAE Open End Wrench (770810 ~ 773032)
1/4x5/16 - 3/8x7/16 - 1/2x9/16 - 5/8x11/16 - 3/4x7/8 - 15/16x1"



15°

940g 20 Sets / 18 Kgs / 1.07 CUFT

OW-709S 9pcs SAE Open End Wrench Set

9 SAE Open End Wrench (770810 ~ 773440)
1/4x5/16 - 3/8x7/16 - 1/2x9/16 - 5/8x11/16 - 3/4x7/8 - 13/16x7/8 - 15/16x1" - 1"x1 1/8" - 1 1/16x1 1/4"



15°

2150g 6 Sets / 14 Kgs / 0.71 CUFT

Double Flexible Socket Wrenches

Metric Double Flexible Socket Wrenches - Mirror Finish

ITEM NO.	Size mm	Length mm
500607	6 x 7	185
500809	8 x 9	185
501011	10 x 11	200
501213	12 x 13	220
501415	14 x 15	240
501617	16 x 17	255
501819	18 x 19	270
502022	20 x 22	305
502123	21 x 23	305
502427	24 x 27	335
503032	30 x 32	345

SAE Double Flexible Socket Wrenches - Mirror Finish

ITEM NO.	Size Inch	Length mm
511214	3/8 x 7/16	200
511618	1/2 x 9/16	225
512022	5/8 x 11/16	260
512428	3/4 x 7/8	300

DF-506M 6pcs Metric Double Flexible Socket Wrench Set

6 Metric Double Flexible Socket Wrench (500809 ~ 501819)
8x9 - 10x11 - 12x13 - 14x15 - 16x17 - 18x19mm



1360g 10 Sets / 15 Kgs / 0.71 CUFT

DF-504S 4pcs SAE Double Flexible Socket Wrench Set

4 SAE Double Flexible Socket Wrench (511214 ~ 512428)
3/8x7/16 - 1/2x9/16 - 5/8x11/16 - 3/4x7/8"



1250g 10 Sets / 13.5 Kgs / 0.71 CUFT

Wrench Sets

MS-020B 20pcs Metric Box End, Open End & E-Star Wrench Set

8 Box End Wrench (740607 ~ 742022)
6x7 - 8x9 - 10x11 - 12x13 - 14x15 - 16x17 - 18x19 - 20x22mm

8 Open End Wrench (790607 ~ 792022)
6x7 - 8x9 - 10x11 - 12x13 - 14x15 - 16x17 - 18x19 - 20x22mm

4 E-Star Wrench (790608 ~ 792024)
E6x8 - 10x12 - 14x18 - 20x24



1/2 Tray 2700g 3 Sets / 9 Kgs / 1.35 CUFT

MS-041MS 41pcs Metric & SAE Combination & Flare Nut Wrench

18 Metric Combination Wrench
6 - 7 - 8 - 9 - 10 - 11 - 12 - 13 - 14 - 15 - 16 - 17 - 18 - 19 - 21 - 22 - 23 - 24mm

12 SAE Combination Wrench
1/4 - 5/16 - 3/8 - 7/16 - 1/2 - 9/16 - 5/8 - 11/16 - 3/4 - 13/16 - 7/8 - 15/16"

6 Metric Flare Nut Wrench
9x11 - 10x12 - 13x14 - 15x17 - 16x18 - 19x21mm

5 SAE Flare Nut Wrench
1/4x5/16 - 3/8x7/16 - 1/2x9/16 - 5/8x11/16 - 3/4x7/8"



Full Tray 6500g 2 Sets / 15.5 Kgs / 1.76 CUFT

Wrenches

Key Wrench Sets- S2 Material

NEW **HK-09MS 9pcs Metric Hex Key Wrench Set**

9 Metric Hex Key Wrench (570515S ~ 571210S)
1.5 - 2 - 2.5 - 3 - 4 - 5 - 6 - 8 - 10mm

Plastic Holder
310g 72 Sets / 24 Kgs / 1.88 CUFT

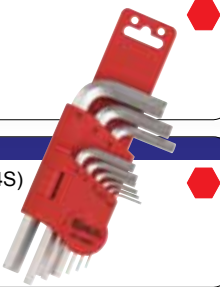

NEW **HK-09SS 9pcs SAE Hex Key Wrench Set**

9 SAE Hex Key Wrench (590504S ~ 591124S)
1/16 - 5/64 - 3/32 - 1/8 - 5/32 - 3/16 - 1/4 - 5/16 - 3/8"

Plastic Holder
300g 72 Sets / 24 Kgs / 1.88 CUFT



NEW **HK-10MS 10pcs Metric Hex Key Wrench Set**

10 Metric Hex Key Wrench (570515S ~ 571210S)
1.5 - 2 - 2.5 - 3 - 4 - 5 - 5.5 - 6 - 8 - 10mm

Plastic Holder
310g 72 Sets / 23.5 Kgs / 1.44 CUFT



NEW **HK-10SS 10pcs SAE Hex Key Wrench Set**

10 SAE Hex Key Wrench (590504S ~ 591124S)
1/16 - 5/64 - 3/32 - 1/8 - 5/32 - 3/16 - 7/32 - 1/4 - 5/16 - 3/8"

Plastic Holder
300g 72 Sets / 22.5 Kgs / 1.44 CUFT



NEW **HK-09MLS 9pcs Metric Long Hex Key Wrench Set**

9 Metric Long Hex Key Wrench (570915LS ~ 572210LS)
1.5 - 2 - 2.5 - 3 - 4 - 5 - 6 - 8 - 10mm

Plastic Holder
500g 36 Sets / 19 Kgs / 1.7 CUFT



NEW **HK-09MBS 9pcs Metric Wobble Hex Key Wrench Set**

9 Metric Wobble Hex Key Wrench (570915BS ~ 572210BS)
1.5 - 2 - 2.5 - 3 - 4 - 5 - 6 - 8 - 10mm

Plastic Holder
480g 36 Sets / 19 Kgs / 1.7 CUFT



NEW **HK-09SBS 9pcs SAE Wobble Hex Key Wrench Set**

9 SAE Wobble Hex Key Wrench (590904BS ~ 592324BS)
1/16 - 5/64 - 3/32 - 1/8 - 5/32 - 3/16 - 1/4 - 5/16 - 3/8"

Plastic Holder
480g 36 Sets / 19 Kgs / 1.7 CUFT



NEW **SK-010SS 10pcs Star Key Wrench Set**

10 Star Key Wrench (580809S ~ 580950S)
T9 - T10 - T15 - T20 - T25 - T27 - T30 - T40 - 45 - T50

Plastic Holder
280g 72 Sets / 22 Kgs / 1.5 CUFT



NEW **SK-010TS 10pcs Tamperproof Star Key Wrench Set**

10 Tamperproof Star Key Wrench (580809TS ~ 582250TS)
T9 - T10 - T15 - T20 - T25 - T27 - T30 - T40 - T45 - T50

Plastic Holder
480g 36 Sets / 19.3 Kgs / 1.8 CUFT

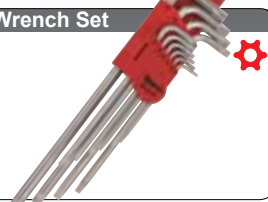

NEW **HK-07TSS 7pcs Triple Square Key Wrench Set**

7 Triple Square Key Wrench (582705MS ~ 583416MS)
M5 - M6 - M8 - M10 - M12 - M14 - M16

Plastic Holder
920g 20 Sets / 19.5 Kgs / 1.07 CUFT



Hex Key Wrenches

Metric Hex Key Wrenches			SAE Hex Key Wrenches		
ITEM NO.	Size mm	Length mm	ITEM NO.	Size Inch	Length mm
570515	1.5	45	590503	1/20	40
570520	2	50	590504	1/16	45
570625	2.5	56	590605	5/64	50
570630	3	63	590606	3/32	56
570735	3.5	65	590607	7/64	59
570740	4	70	590608	1/8	63
570845	4.5	75	590709	9/64	65
570850	5	80	590710	5/32	70
570855	5.5	85	590812	3/16	80
570960	6	90	590814	7/32	85
570970	7	95	590916	1/4	90
571080	8	100	591020	5/16	100
571190	9	106	591124	3/8	112
571210	10	112	591328	7/16	118
571211	11	118	591432	1/2	125
571312	12	125	591536	9/16	140
571313	13	132	591540	5/8	160
571414	14	140	591848	3/4	180
571516	16	153			
571617	17	160			
571719	19	180			

Metric Long Hex Key Wrenches			SAE Long Hex Key Wrenches		
ITEM NO.	Size mm	Length mm	ITEM NO.	Size Inch	Length mm
570915L	1.5	90	590803L	1/20	72
571020L	2	100	590904L	1/16	90
571125L	2.5	112	591005L	5/64	100
571230L	3	126	591106L	3/32	112
571335L	3.5	134	591208L	1/8	126
571440L	4	142	591310L	5/32	142
571545L	4.5	150	591512L	3/16	160
571650L	5	160	591614L	7/32	170
571760L	6	180	591816L	1/4	180
571870L	7	190	592020L	5/16	200
572080L	8	200	592324L	3/8	224
572190L	9	210	592428L	7/16	236
572210L	10	224	592632L	1/2	250
572411L	11	236	592836L	9/16	280
572512L	12	250	593040L	5/8	320
572613L	13	260	593248L	3/4	360
572814L	14	280			
572916L	16	300			
573117L	17	320			
573219L	19	360			

HK-007MF 7pcs Metric Hex Key Wrench Folding Set

7 Hex Key
1.27 - 1.5 - 2 - 2.5 - 3 - 4 - 5mm

130g 144 Sets / 20 Kgs / 2 CUFT



HK-009SF 9pcs SAE Hex Key Wrench Folding Set

9 Hex Key
1/20 - 1/16 - 5/64 - 3/32 - 7/64 - 1/8 - 9/64 - 5/32 - 3/16"

130g 144 Sets / 21 Kgs / 2 CUFT



Hex Key Wrench Sets

HK-009M 9pcs Metric Hex Key Wrench Set

9 Metric Hex Key Wrench (570515 ~ 571210)
1.5 - 2 - 2.5 - 3 - 4 - 5 - 6 - 8 - 10mm

Plastic Holder
310g 72 Sets / 24 Kgs / 1.88 CUFT

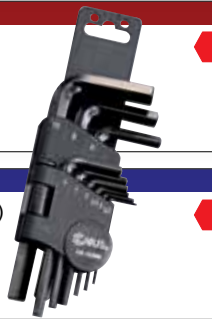

HK-009S 9pcs SAE Hex Key Wrench Set

9 SAE Hex Key Wrench (590504 ~ 591124)
1/16 - 5/64 - 3/32 - 1/8 - 5/32 - 3/16 - 1/4 - 5/16 - 3/8"

Plastic Holder
300g 72 Sets / 24 Kgs / 1.88 CUFT



HK-010M 10pcs Metric Hex Key Wrench Set

10 Metric Hex Key Wrench (570515 ~ 571210)
1.5 - 2 - 2.5 - 3 - 4 - 5 - 5.5 - 6 - 8 - 10mm

Plastic Holder
310g 72 Sets / 23.5 Kgs / 1.44 CUFT



HK-010S 10pcs SAE Hex Key Wrench Set

10 SAE Hex Key Wrench (590504 ~ 591124)
1/16 - 5/64 - 3/32 - 1/8 - 5/32 - 3/16 - 7/32 - 1/4 - 5/16 - 3/8"

Plastic Holder
300g 72 Sets / 22.5 Kgs / 1.44 CUFT



HK-025MS 25pcs Metric & SAE Hex Key Wrench Set

13 Metric Hex Key (570515 ~ 571210)
1.5 - 2 - 2.5 - 3 - 4 - 4.5 - 5 - 5.5 - 6 - 7 - 8 - 9 - 10mm

12 SAE Hex Key (590504 ~ 591124)
1/16 - 5/64 - 3/32 - 7/64 - 1/8 - 9/64 - 5/32 - 3/16 - 7/32 - 1/4 - 5/16 - 3/8"

840g 24 Sets / 21 Kgs / 0.92 CUFT



HK-009ML 9pcs Metric Long Hex Key Wrench Set

9 Metric Long Hex Key Wrench (570915L ~ 572210L)
1.5 - 2 - 2.5 - 3 - 4 - 5 - 6 - 8 - 10mm

Plastic Holder
500g 36 Sets / 19 Kgs / 1.7 CUFT



Triple Square Key Wrenches

ITEM NO.	Size	Length mm
582705M	M5	72
582806M	M6	80
582908M	M8	90
583010M	M10	100
583112M	M12	112
583214M	M14	125
583416M	M16	140

Triple Square Key Wrenches



HK-007TS 7pcs Triple Square Key Wrench Set

Triple Square Key Wrench (582705M ~ 583416M)
M5 - M6 - M8 - M10 - M12 - M14 - M16

920g 20 Sets / 19.5 Kgs / 1.07 CUFT



Wobble Hex Key Wrenches

Metric Wobble Hex Key Wrenches

ITEM NO.	Size mm	Length mm
570915B	1.5	90
571020B	2	100
571125B	2.5	112
571230B	3	126
571335B	3.5	134
571440B	4	142
571545B	4.5	150
571650B	5	160
571760B	6	180
571870B	7	190
572080B	8	200
572190B	9	210
572210B	10	224

SAE Wobble Hex Key Wrenches

ITEM NO.	Size Inch	Length mm
590904B	1/16	90
591005B	5/64	100
591106B	3/32	112
591208B	1/8	126
591310B	5/32	142
591512B	3/16	160
591614B	7/32	170
591816B	1/4	180
592020B	5/16	200
592324B	3/8	224

HK-009MB 9pcs Metric Wobble Hex Key Wrench Set

9 Metric Wobble Hex Key Wrench (570915B ~ 572210B)
1.5 - 2 - 2.5 - 3 - 4 - 5 - 6 - 8 - 10mm

Plastic Holder
480g 36 Sets / 19 Kgs / 1.7 CUFT

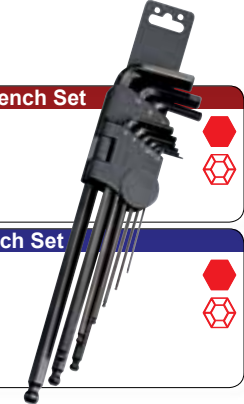

HK-009SB 9pcs SAE Wobble Hex Key Wrench Set

9 SAE Wobble Hex Key Wrench (590904B ~ 592324B)
1/16 - 5/64 - 3/32 - 1/8 - 5/32 - 3/16 - 1/4 - 5/16 - 3/8"

Plastic Holder
480g 36 Sets / 19 Kgs / 1.7 CUFT

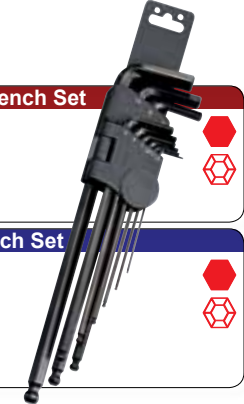

Star Key Wrenches

Star Key Wrenches

ITEM NO.	Size	Length mm
580506	T-6	44
580507	T-7	57
580508	T-8	50
580509	T-9	55
580510	T-10	60
580615	T-15	64
580620	T-20	68
580625	T-25	72
580627	T-27	78
580730	T-30	83
580840	T-40	89
580845	T-45	96
580950	T-50	105
581055	T-55	116
581260	T-60	125
581470	T-70	140

Tamperproof Star Key Wrenches

ITEM NO.	Size Inch	Length mm
580807T	T-7	71
580808T	T-8	76
580809T	T-9	80
580910T	T-10	86
580915T	T-15	90
581020T	T-20	95
581025T	T-25	100
581127T	T-27	105
581230T	T-30	114
581240T	T-40	124
581345T	T-45	137
581550T	T-50	152
581755T	T-55	171
581960T	T-60	190
582270T	T-70	220

SK-010S 10pcs Star Key Wrench Set

10 Tamperproof Star Key Wrench (580809 ~ 580950)
T9 - T10 - T15 - T20 - T25 - T27 - T30 - T40 - T45 - T50

Plastic Holder
280g 72 Sets / 22 Kgs / 1.5 CUFT



SK-010T 10pcs Tamperproof Star Key Wrench Set

10 Tamperproof Star Key Wrench (580809T ~ 582250T)
T9 - T10 - T15 - T20 - T25 - T27 - T30 - T40 - T45 - T50

Plastic Holder
480g 36 Sets / 19.3 Kgs / 1.8 CUFT



Wrenches

Adjustable Wrenches

Adjustable Wrenches

ITEM NO.	Jaw Capacity mm	Length mm
780128	13	100
780192	19	150
780256	24	200
780320	28	250
780384	33	300
780480	42	380
780576	52	450
780692	62	600



Pipe Wrenches

Heavy Duty Pipe Wrenches

ITEM NO.	Length mm (Inch)	Weight g
782200	200 (8")	470
782250	250 (10")	840
782300	300 (12")	1100
782350	350 (14")	1420
782460	460 (18")	2440
782610	610 (24")	4330
782910	910 (36")	8000
783220	1220 (48")	14000

Chrome Molybdenum Steel Hook Jaw



Aluminum Pipe Wrenches

ITEM NO.	Length mm (Inch)	Weight g
784350	350 (14")	880
784460	460 (18")	1460
784610	610 (24")	2440
784910	910 (36")	4500
785220	1220 (48")	8000

Chrome Molybdenum Steel Hook Jaw



Heavy Duty Pipe Wrenches

ITEM NO.	Length mm (Inch)	Weight g
V782S08	200 (8")	360
V782S10	250 (10")	770
V782S12	300 (12")	1100
V782S14	350 (14")	1600
V782S18	460 (18")	2440
V782S24	610 (24")	3700
V782S36	910 (36")	8400
V782S48	1220 (48")	13500

Chrome Vanadium Steel Hook Jaw



Aluminum Pipe Wrenches

ITEM NO.	Length mm (Inch)	Weight g
V794A14	350 (14")	1000
V794A18	460 (18")	1630
V794A24	610 (24")	2440
V794A36	910 (36")	5000
V794A48	1220 (48")	8000

Chrome Vanadium Steel Hook Jaw



Torque Wrenches

1/4" Dr. Torque Wrenches

ITEM NO.	Capacity	Length mm
280030N	6~30 Nm	350
280250L	40~250 in.lb.	350

3/8" Dr. Torque Wrenches

ITEM NO.	Capacity	Length mm
380030N	6~30 Nm	350
380110N	19~110 Nm	385
380250L	40~250 in.lb.	350
380080F	15~80 ft.lb.	385

1/2" Dr. Torque Wrenches

ITEM NO.	Capacity	Length mm
480210N	40~210 Nm	535
480350N	70~350 Nm	645
480150F	30~150 ft.lb.	535
480250F	50~250 ft.lb.	645

3/4" Dr. Torque Wrenches

ITEM NO.	Capacity	Length mm
680500N	100~500 Nm	865
680700N	140~700 Nm	1092
680980N	140~980 Nm	1230
681500N	300~1500Nm	1700
680300F	50~300 ft.lb.	865
680600F	100~600 ft.lb.	1092
680700F	100~700 ft.lb.	1230
681000F	200~1000 ft.lb.	1700

1" Dr. Torque Wrenches

ITEM NO.	Capacity	Length mm
880980N	140~980 Nm	1230
881500N	300~1500Nm	1700
880700F	100~700 ft.lb.	1230
881000F	200~1000 ft.lb.	1700



Torque Multipliers **⚠ Caution: Do not use with impact wrench**

ITEM NO.	Drive Inch	Capacity	Length mm
401000	Input: 1/2" Output: 3/4"	Max: 460 Nm / 340 ft.lbs Max: 1,400 Nm / 1,000 ft.lbs Output / Input = 3 / 1	420
602000	Input: 3/4" Output: 1"	Max: 900 Nm / 650 ft.lbs Max: 2,700 Nm / 2,000 ft.lbs Output / Input = 3 / 1	500



ITEM NO.	Drive Inch	Capacity	Length mm
401500	Input: 1/2" Output: 3/4"	Max: 150 Nm / 110 ft.lbs Max: 1,500 Nm / 1,100 ft.lbs Output / Input = 10 / 1	200

NEW



Torque Handle Sets

3pcs Digital Interchangeable Torque Wrench Set

ITEM NO.	Torque Range	Length
1434N10	10 ~ 100 Nm	14x18
1434N20	20 ~ 200 Nm	14x18

NEW
Digital

- Digital Interchangeable Torque Handle
- 3/8" & 1/2" Quick Release Ratchet Heads



2000g 6 Sets / 13.0 Kgs / 0.92 CUFT (1434N10)
 2250g 6 Sets / 14.5 Kgs / 0.92 CUFT (1434N20)

10pcs Torque Handle Set

ITEM NO.	Torque Range	Length
TO-210N30	6 ~ 30 Nm	9x12
TO-210F25	50 ~ 250 in. lb.	9x12

- Interchangeable Torque Handle
- 1/4" Dr. Ratchet Head 9 x 12
- 8 Open Ended Heads 9 x 12: 7, 8, 9, 10, 11, 12, 13, 14 mm

NEW



1650g 10 Sets / 17 Kgs / 1.39 CUFT

8pcs Torque Handle Set

ITEM NO.	Torque Range	Length
TO-408N80	15 ~ 80 Nm	14x18
TO-408F60	10 ~ 60 ft. lb.	14x18

- Interchangeable Torque Handle
- 1/2" Dr. Ratchet Head 14 x 18
- 6 Open Ended Heads 14 x 18: 17, 22, 24, 26, 27, 29 mm

NEW



3350g 6 Sets / 20.6 Kgs / 1.3 CUFT

12pcs Torque Handle Set

ITEM NO.	Torque Range	Length
TO-312N11	19 ~ 110 Nm	9x12
TO-312F80	15 ~ 80 ft. lb.	9x12

- Interchangeable Torque Handle
- 3/8" Dr. Ratchet Head 9 x 12
- 10 Open Ended Heads 9 x 12: 10, 11, 12, 13, 14, 15, 16, 17, 18, 19 mm

NEW



2240g 6 Sets / 13.9 Kgs / 1.13 CUFT

11pcs Torque Handle Set

ITEM NO.	Torque Range	Length
TO-411N21	40 ~ 210 Nm	14x18
TO-411F15	30 ~ 150 ft. lb.	14x18

- Interchangeable Torque Handle
- 1/2" Dr. Ratchet Head 14 x 18
- 9 Open Ended Heads 14 x 18: 13, 14, 15, 17, 19, 22, 24, 27, 30mm

NEW



4380g 4 Sets / 18.1 Kgs / 0.86 CUFT

8pcs Torque Handle Hook Head Set

ITEM NO.	Torque Range	Length
TO-148N21	40 ~ 210 Nm	14x18
TO-148F15	30 ~ 150 ft. lb.	14x18

- Interchangeable Torque Handle
- 7 Hook Heads 14 x 18: No. 14H012, 14H016, 14H025, 14H032, 14H075, 14H100, 14H150

NEW



4000g 4 Sets / 16.6 Kgs / 0.86 CUFT

Digital Torque Wrenches

NEW

ITEM NO.	Drive	Capacity	Length
V38200	3/8"	20 ~ 200 Nm	595
V48340	1/2"	34 ~ 340 Nm	790

V-MARK

- Accuracy: CW ±1%, CCW ±1.5%
- Unit selection: Nm, ft.lb., in.lb., kg-m
- Battery: AAA x 2
- Non-Slip Metal Handle
- ISO-6789 Standard Compliant

1940g 6 Sets / 13 Kgs / 1.52 CUFT (V38200)
 2500g 4 Sets / 11 Kgs / 1.37 CUFT (V48340)

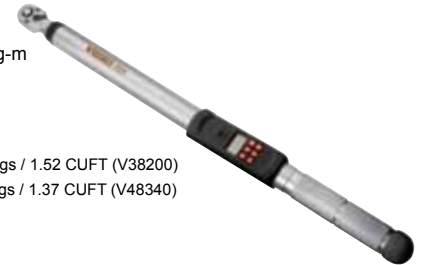

Torque Handle Fittings

NEW



Open Ended Heads

ITEM NO.	Size mm	Length mm
091207	7	37
091208	8	37
091209	9	37
091210	10	38
091211	11	38
091212	12	39
091213	13	42
091214	14	42
091215	15	43
091216	16	44
091217	17	44
091218	18	44
091219	19	46

ITEM NO.	Size mm	Length mm
141813	13	62
141814	14	63
141815	15	64
141816	16	64
141817	17	64
141818	18	65
141819	19	65
141821	21	66
141822	22	66
141824	24	67
141826	26	70
141827	27	70
141829	29	74
141830	30	74
141832	32	76

NEW



Hook Heads

ITEM NO.	Clamping Range mm	Weight g
14H012	32±5	210
14H016	43±5	260
14H025	60±5	260
14H032	72±5	290
14H075	50±5	250
14H100	63±5	260
14H150	82±5	290

NEW



Collet Heads

ITEM NO.	Clamping Range mm	Weight g
14CH16	32±5	210
14CH20	35±5	260
14CH25	42±5	260
14CH32	50±5	290
14CH40	63±5	250

A range of torque handle fittings are available for GENIUS torque handles.

Quick Release Ratchet Heads

ITEM NO.	Length mm	Weight g
14DT38	73	210
14DT48	94	410

NEW



Ratchet Heads

ITEM NO.	Length mm	Weight g
09RH20	56	85
09RH33	56	90
09RH30	69	170
14RH30	78	210
09RH44	69	180
14RH44	78	220
14RH40	94	410

NEW



Various sizes and styles of ratchet heads are available for GENIUS torque handles, both the 1/4" - 1/2" spigot versions.

Pliers w/ Cushion Grips



A Diagonal Cutting Pliers

ITEM NO.	Length mm (Inch)
550507	130 (5")
550607	150 (6")
550707	180 (7")



B Chain Nose Pliers w/ Cutter

ITEM NO.	Length mm (Inch)
550504	130 (5")
550604	150 (6")
550804	200 (8")



C Heavy Duty Diagonal Cutting Pliers

ITEM NO.	Length mm (Inch)
550708	175 (7")
550808	200 (8")

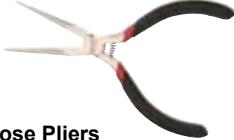

D Needle Nose Pliers

ITEM NO.	Length mm (Inch)
550606	150 (6")



E Duckbill Pliers

ITEM NO.	Length mm (Inch)
550805	200 (8")



F Combination (Slip Joint) Pliers

ITEM NO.	Length mm (Inch)
550609	150 (6")
550809	200 (8")
551009	250 (10")



G Tongue & Groove Pliers

ITEM NO.	Length mm (Inch)
550611	150 (6")
550811	200 (8")
551011	250 (10")
551211	300 (12")
551611	400 (16")

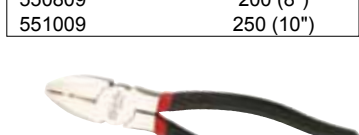

H Side Cutter Pliers

ITEM NO.	Length mm (Inch)
550712	175 (7")
550812	200 (8")



I Hose Clamp Pliers

ITEM NO.	Length mm (Inch)
550810	200 (8")



J End Cutter Pliers

ITEM NO.	Length mm (Inch)
550613	150 (6")

CP-5704 4pcs Pliers Set

- 1 8" Side Cutter Pliers (550812)
- 1 7" Diagonal Cutting Pliers (550707)
- 1 8" Chain Nose Pliers w/ Cutter (550804)
- 1 8" Combination Slip Joint Pliers (550809)



1/3 Tray 1630g 10 Sets / 17.5 Kgs / 1.58 CUFT

Pliers w/ Plastic Handle



A Bent Nose Pliers

ITEM NO.	Length mm (Inch)
550614D	150 (6")
550814D	200 (8")



B Chain Nose Pliers w/ Cutter

ITEM NO.	Length mm (Inch)
550604D	150 (6")
550804D	200 (8")



C Side Cutter Pliers

ITEM NO.	Length mm (Inch)
550612D	150 (6")
550712D	175 (7")
550812D	200 (8")



D Diagonal Cutting Pliers

ITEM NO.	Length mm (Inch)
550607D	150 (6")



E Heavy Duty Diagonal Cutting Pliers

ITEM NO.	Length mm (Inch)
550708D	175 (7")
550808D	200 (8")



F Water Pump Pliers w/ Cushion Grip

ITEM NO.	Length mm (Inch)
551011D	250 (10")

Pliers w/ Double Color Soft Handle



A Bent Nose Pliers

ITEM NO.	Length mm (Inch)
550614S	150 (6")
550814S	200 (8")



B Chain Nose Pliers w/ Cutter

ITEM NO.	Length mm (Inch)
550604S	150 (6")
550804S	200 (8")



C Side Cutter Pliers

ITEM NO.	Length mm (Inch)
550612S	150 (6")
550712S	180 (7")
550812S	200 (8")



D Diagonal Cutting Pliers

ITEM NO.	Length mm (Inch)
550607S	150 (6")



E Heavy Duty Diagonal Cutting Pliers

ITEM NO.	Length mm (Inch)
550708S	175 (7")
550808S	200 (8")

CP-5804 4pcs General Purpose Pliers Set

- 1 6" Chain Nose Pliers w/ Cutter (550604D)
- 1 6" Diagonal Cutting Pliers (550607D)
- 1 7" Side Cutter Pliers (550712D)
- 1 10" Water Pump Pliers (551011D)



1/3 Tray 1590g 10 Sets / 17 Kgs / 1.58 CUFT

Locking Pliers



A Straight Jaw Locking Pliers

ITEM NO.	Length mm (Inch)
530307RA	175 (7")
530310RA	250 (10")



B Curved Jaw Locking Pliers w/ Cutter

ITEM NO.	Length mm (Inch)
530305A	125 (5")
530307A	175 (7")
530310A	250 (10")



C Large Jaw Locking Pliers

ITEM NO.	Length mm (Inch)
534312LJ	250 (10")



D Long Nose Locking Pliers w/ Cutter

ITEM NO.	Length mm (Inch)
531306LN	150 (6")
531309LN	225 (9")



E Sheet Metal Pliers

ITEM NO.	Length mm (Inch)
532308SM	200 (8")



F Locking Welding Clamp

ITEM NO.	Length mm (Inch)
533309LW	225 (9")



G Locking "C" Clamps w/Swivel Pads

ITEM NO.	Length mm (Inch)
530306AR	150 (6")
530311AR	280 (11")
530318AR	460 (18")
530324AR	610 (24")



H Locking "C" Clamps

ITEM NO.	Length mm (Inch)
539606	150 (6")
539611	280 (11")
539618	460 (18")
539624	610 (24")



I Pinch-Off Locking Pliers

ITEM NO.	Length mm (Inch)
537807	175 (7")
537811	280 (11")



J Locking Chain Pliers

ITEM NO.	Length mm (Inch)
538418	460 (18")



K Claw-Grip Pliers

ITEM NO.	Length mm (Inch)
536062	150 (6")



L Claw-Grip Pliers

ITEM NO.	Length mm (Inch)
536064	150 (6")



M Hose Clamp Pliers

ITEM NO.	Length mm (Inch)
535307	180 (7")
535309	230 (9")



N Oil Filter Locking Pliers

ITEM NO.	Length mm (Inch)
AT-OF10A	250 (10")

■ Jaw Opening: 2-1/8"~4-5/8" (53~118mm)

Retaining Ring Pliers

ITEM NO.	Type	Diameter Tip	Angle Tip	Length mm (Inch)
a. 550550	External	1.3mm	Straight	125 (5")
b. 550551	Internal	1.3mm	Straight	125 (5")
c. 550552	External	1.3mm	90°	125 (5")
d. 550553	Internal	1.3mm	90°	125 (5")
a. 550750	External	1.8mm	Straight	175 (7")
b. 550751	Internal	1.8mm	Straight	175 (7")
c. 550752	External	1.8mm	90°	175 (7")
d. 550753	Internal	1.8mm	90°	175 (7")
a. 550950	External	2.0mm	Straight	225 (9")
b. 550951	Internal	2.0mm	Straight	225 (9")
c. 550952	External	2.0mm	90°	225 (9")
d. 550953	Internal	2.0mm	90°	225 (9")
a. 551250	External	2.5mm	Straight	300 (12")
b. 551251	Internal	2.5mm	Straight	300 (12")
c. 551252	External	2.5mm	90°	300 (12")
d. 551253	Internal	2.5mm	90°	300 (12")



a. External-Straight



b. Internal-Straight

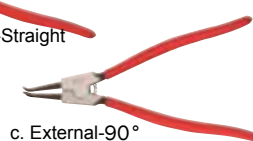

c. External-90°



d. Internal-90°

RP-5504 4pcs Retaining Ring Pliers Set

- 1 Straight Nose, External (550750)
- 1 Straight Nose, Internal (550751)
- 1 90° Bent Nose, External (550752)
- 1 90° Bent Nose, Internal (550753)



850g

10 Sets / 9.5 Kgs / 0.93 CUFT



Aviation Snips

Straight Tip Aviation Snips

ITEM NO.	Description	Length mm
a. 511001L	Left Cut Aviation Snip. Cuts straight and tight curves to the left.	250
b. 511002R	Right Cut Aviation Snip. Cuts straight and tight curves to the right.	250
c. 511003S	Straight Cut Aviation Snip. Cuts straight and wide curves to the left and right.	250

Offset Tip Aviation Snips

ITEM NO.	Description	Length mm
d. 511004L	Offset-Left Cut Aviation Snip. Cuts straight and tight left curves.	250
e. 511005R	Offset-Right Cut Aviation Snip. Cuts straight and tight right curves.	250

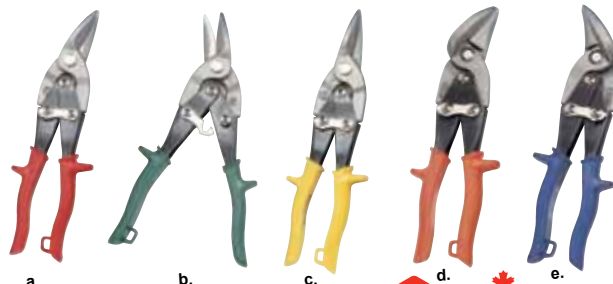

a.

b.

c.

d.

e.

Striking Tools

Hammers



A Claw Hammers

ITEM NO.	Head Weight	Length mm
590116	1 lbs./454g	330
590120	1-1/4 lbs./567g	335



B Ball Peen Hammers

ITEM NO.	Head Weight	Length mm
590208	1/2 lbs./227g	280
590212	3/4 lbs./340g	300
590216	1 lbs./454g	330
590224	1-1/2 lbs./681g	350
590232	2 lbs./908g	380



C Drilling Hammers

ITEM NO.	Head Weight	Length mm
590348	2-1/2 lbs./1135g	270
590364	4 lbs./1816g	270



D Rubber Mallet

ITEM NO.	Head Weight	Length mm
590524	1-1/2 lbs./680g	330

E Soft Face Hammer

ITEM NO.	Head Weight	Length mm
590416	1 lbs./454g	320



Punches & Chisels



Metric Pin Punches

ITEM NO.	Size mm	Length mm
565102	2	100
565123	3	125
565144	4	140
565165	5	160
565205	5	200
565166	6	160
565206	6	200
565208	8	200



SAE Pin Punches

ITEM NO.	Size Inch	Length mm
566102	1/16	100
566103	3/32	100
566124	1/8	125
566145	5/32	140
566166	3/16	160
566206	3/16	200
566168	1/4	160
566208	1/4	200
566210	5/16	200



Long Taper Line Up Punches

ITEM NO.	Size mm	Length mm
564202	2	200
564203	3	200
564254	4	250
564255	5	250
564286	6	280



Center Punches

ITEM NO.	Size mm	Length mm
563100	3	100
563110	4	110
563125	5	125
563140	6	140
563160	8	160



Oval Bearing Punches

ITEM NO.	Size mm / Inch	Length mm
565311	11x6 (7/16x1/4)	150
565313	13x7 (1/2x7/16)	250
565315	15x8 (9/16x1/2)	350
565317	17x9 (5/8x3/4)	500



Flat Chisels

ITEM NO.	Size mm	Length mm
561206	6	125
561410	10	140
561612	12	150
561614	14	150
561616	16	160
562019	19	200
563019	19	300
562022	22	200
563022	22	300
562025	25	200

Punch & Chisel Sets

PC-566MP 6pcs Metric Pin Punch Set

- 6 Metric Pin Punch
(565102 ~ 565208)
2 - 3 - 4 - 5 - 6 - 8mm



500g 10 Sets / 6 Kgs / 0.62 CUFT

PC-577SP 7pcs SAE Pin Punch Set

- 7 SAE Pin Punch
(566102 ~ 566210)
1/16 - 3/32 - 1/8 - 5/32 -
3/16 - 1/4 - 5/16"



520g 10 Sets / 6.5 Kgs / 0.62 CUFT

PC-567F 7pcs Flat Chisel Set

- 7 Flat Chisel
(561206 ~ 562022)
6 - 10 - 12 - 14 -
16 - 19 - 22mm



1250g 10 Sets / 13.5 Kgs / 0.62 CUFT

PC-565LU 5pcs Long Taper Line Up Punch Set

- 5 Long Taper Line Up Punch
(564202 ~ 564286)
2 - 3 - 4 - 5 - 6mm



680g 20 Sets / 15 Kgs / 0.7 CUFT

PC-575C 5pcs Center Punch Set

- 5 Center Punch
(563100 ~ 563160)
3 - 4 - 5 - 6 - 8mm



620g 10 Sets / 7.5 Kgs / 0.62 CUFT

PC-BP4 4pcs Oval Bearing Punch Set

- 4 Oval Bearing Punch
(565311 ~ 565317)
11x6mm (7/16"x1/4") - 13x7mm (1/2"x7/16") -
15x8mm (9/16"x1/2") - 17x9mm (5/8"x3/4")



1500g 15 Sets / 23.5 Kgs / 0.82 CUFT

Punch & Chisel Sets

PC-514M 14pcs Metric Punch & Chisel Set

- 5 Pin Punch (565102 ~ 565166)
2 - 3 - 4 - 5 - 6mm
- 5 Flat Chisel (561206 ~ 561616)
6 - 10 - 12 - 14 - 16mm
- 2 Long Taper Line Up Punch:
(564203 ~ 564255)
3 - 5mm
- 2 Center Punch:
(563100 ~ 563125)
3 - 5mm



1140g 6 Sets / 8 Kgs / 0.45 CUFT

PC-514S 14pcs SAE Punch & Chisel Set

- 5 Pin Punch (566103 ~ 566168)
3/32 - 1/8 - 5/32 - 3/16 - 1/4"
- 5 Flat Chisel (561206 ~ 561616)
6 - 10 - 12 - 14 - 16mm
- 2 Long Taper Line Up Punch
(564203 ~ 564255)
3 - 5mm
- 2 Center Punch
(563100 ~ 563125)
3 - 5mm



1140g 6 Sets / 8 Kgs / 0.45 CUFT

MS-013 13pcs Tang-Thru Screwdriver, Pry Bar & Carbon Scraper

- 2 Slotted Tang-Thru Screwdriver
6.5x245 - 14x365mmL
- 2 Philips Tang-Thru Screwdriver
#1x220 - 4x305mmL
- 4 Posidriv Tang-Thru Screwdriver
#1x200 - 2x245 - 3x270 - 4x320mmL
- 3 Rigid Carbon Scraper
12x250 - 26x200 - 26x300mmL
- 2 Pry Bar
200mmL (8"L) - 300mmL (12"L)

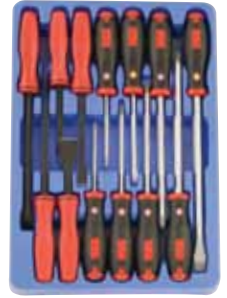

1/2 Tray 2920g 3 Sets / 10 Kgs / 1.35 CUFT

MS-019 19pcs Punch, Chisel & Hammer Set

- 5 Flat Chisel
6 - 10 - 14 - 19 - 25mm
- 6 Pin Punch
2 - 3 - 4 - 5 - 6 - 8mm
- 1 Center Punch
4mm
- 5 Taper Bit Extractor
3 - 5 - 6 - 8 - 9mm
- 1 Ball Peen Hammer 1 lbs. (454 g)
- 1 Drilling Hammer 2 1/2 lbs. (1135 g)



1/2 Tray 3900g 3 Sets / 13.5 Kgs / 1.35 CUFT

MS-023 23pcs Punch, Chisel & Hammer Set

- 9 Punch
Pin 2 - 3 - 4 - 5 - 6mm
Center 3 - 5mm
Line Up 3 - 5mm
- 5 Flat Chisel
6 - 10 - 12 - 14 - 16mm
- 2 Slotted Tang-Thru Screwdriver
10 - 12mm
- 2 Philips Tang-Thru Screwdriver
#2 - #3
- 4 Claw Hammer - Ball Peen Hammer - Drilling Hammer - Soft Face Hammer
- 1 Close Quarter Bar 460mmL (18"L)



Full Tray 6700g 2 Sets / 15 Kgs / 1.76 CUFT

Pry Bars & Sets



Pinch Bar

ITEM NO.	Length mm (Inch)
015638	965 (38")

Close Quarters Bar

ITEM NO.	Length mm (Inch)
015618	455 (18")

Pry Bars

ITEM NO.	Length mm (Inch)
560008	200 (8")
560012	300 (12")
560018	455 (18")
560024	610 (24")
560036	910 (36")

PB-5094 4pcs Pry Bar Set

- 4 Pry Bar
(560008 ~ 560024)
200mm (8") - 300mm (12") - 455mm (18") - 610mm (24")



1670g 12 Sets / 21 Kgs / 1.41 CUFT

Flat Chisel with Handel Guard

ITEM NO.	Size mm	Hex Shank	Length mm
563819P	19	5/8"	380
563822P	22	3/4"	380

NEW



Files

Air Files ø5mm

ITEM NO.	Length mm	Weight g	Pcs/ Box
500861	140	20	50
500862	140	17	50
500863	140	17	50
500864	140	17	50
500865	140	17	50



Diamond Files ø4mm

ITEM NO.	Length mm	Weight g	Pcs/ Box
500781	200	20	50
500782	200	20	50
500783	200	20	50
500784	200	20	50
500785	200	20	50



Small Files

ITEM NO.	Length mm	Weight g	Pcs/ Box
500681	200	45	20
500682	200	30	20
500683	200	45	20
500684	200	30	20
500685	200	40	20
500686	200	45	20
500687	200	40	20



FL-0865 5pcs Air File Set

5 Air Files (500861 ~ 500865)

- flat
- round
- ▲ half round
- square
- ▲ triangle

Plastic Bag 90g 180 Sets / 18 Kgs / 0.92 CUFT



FL-0785 5pcs Diamond File Set

5 Diamond Files (500781 ~ 500785)

- flat
- round
- ▲ half round
- square
- ▲ triangle

Plastic Bag 100g 240 Sets / 27 Kgs / 1.6 CUFT



FL-0687 7pcs Small File set

7 Small Files (500681 ~ 500687)

- flat
- round
- ▲ half round
- square
- ▲ triangle
- ▤ trapezoid
- ⊠ warding

Plastic Bag 280g 80 Sets / 24.5 Kgs / 1.6 CUFT



AF-3406 6pcs Air Files Set

1 Air File Wrench
5 Air Files (500861 ~ 500865)

- flat
- round
- ▲ half round
- square
- ▲ triangle

Plastic Bag 920g 10 Sets / 11.2 Kgs / 1.2 CUFT



Machinists Files (2nd. Cut)

ITEM NO.	Type	Size	Length mm	Weight g
500106	Flat	6"	250	100
500108		8"	300	190
500110		10"	370	350
500112		12"	420	490



ITEM NO.	Type	Size	Length mm	Weight g
500206	Round	6"	250	75
500208		8"	300	100
500210		10"	370	200
500212		12"	420	310



ITEM NO.	Type	Size	Length mm	Weight g
500306	Half Round	6"	250	100
500308		8"	300	170
500310		10"	370	290
500312		12"	420	450



ITEM NO.	Type	Size	Length mm	Weight g
500406	Square	6"	250	80
500408		8"	300	120
500410		10"	370	240
500412		12"	420	310



ITEM NO.	Type	Size	Length mm	Weight g
500506	Triangle	6"	250	95
500508		8"	300	140
500510		10"	370	260
500512		12"	420	390



Air Die Grinder

156000 Air Micro Die Grinder

Free Speed 56,000 rpm
Collet Size..... 3mm (1/8")
Air Pressure 90 psi

360g 12 pcs / 5 Kgs / 0.52 CUFT



DG-1516 16pcs Air Micro Die Grinder Set

- 1 Air Micro Die Grinder
- 1 1/4" Air Oil Lubricator
- 1 1/4" Coupler Fitting Plug
- 10 Mounted Points
- 1 Oil pot
- 2 Wrenches

800g 8 Sets / 7.4 Kgs / 1.16 CUFT

NEW



Pullers

Two-Jaw Gear Pullers

ITEM NO.	Size inch	Spread mm	Weight g
KJ-2076	3"	40 ~ 76	440
KJ-2102	4"	50 ~ 102	760
KJ-2127	5"	55 ~ 127	1160
KJ-2152	6"	60 ~ 152	1840
KJ-2203	8"	80 ~ 203	3920
KJ-2254	10"	100 ~ 254	5740
KJ-2305	12"	120 ~ 305	8240

Material: Chrome Vanadium



Three-Jaw Gear Pullers

ITEM NO.	Size inch	Spread mm	Weight g
KJ-3076	3"	40 ~ 76	560
KJ-3102	4"	50 ~ 102	1040
KJ-3127	5"	55 ~ 127	1620
KJ-3152	6"	60 ~ 152	2560
KJ-3203	8"	80 ~ 203	5480
KJ-3254	10"	100 ~ 254	7880
KJ-3305	12"	120 ~ 305	10840

Material: Chrome Vanadium



Two-Arm Gear Pullers

ITEM NO.	Size mm	Spread mm	Weight g
KA-2080	80	30 ~ 80	1080
KA-2120	120	30 ~ 120	1160
KA-2160	160	40 ~ 160	2680
KA-2200	200	40 ~ 200	2880

Material: Chrome Vanadium

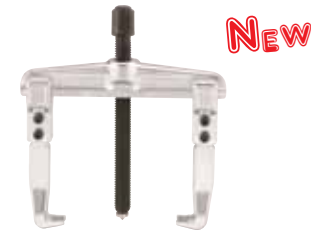

Air Riveters

501940 Super Duty Air Riveter

Specifications:

Traction Power.....	1,940 lbs. / 8,629 Nm
Stroke.....	14mm (0.55")
Working Air Pressure.....	85 ~ 100 psi
Air Consumption.....	4 cfm
Air Inlet.....	1/4 npt
Hose Size.....	3/8 in. / 10mm

With 4 pcs nose pieces:
2.4mm(3/32"), 3.2mm(1/8"),
4.0mm(5/32"), 4.8mm(3/16")

1600g 10 pcs / 18.5 Kgs / 1.6 CUFT

NEW



501990 Heavy Duty Air Riveter

Specifications:

Traction Power.....	1,983 lbs. / 8,820 Nm
Stroke.....	16mm (0.63")
Working Air Pressure.....	85 ~ 100 psi
Air Consumption.....	4 cfm
Air Inlet.....	1/4 npt
Hose Size.....	3/8 in. / 10mm

With 3 pcs nose pieces:
3.2mm(1/8"), 4.0mm(5/32"), 4.8mm(3/16")

1700g 10 pcs / 22 Kgs / 2.5 CUFT

NEW



503100 Ultra Duty Air Riveter

Specifications:

Traction Power.....	3,099 lbs. / 13,784 Nm
Stroke.....	19mm (0.74")
Working Air Pressure.....	85 ~ 100 psi
Air Consumption.....	4.5 cfm
Air Inlet.....	1/4 npt
Hose Size.....	3/8 in. / 10mm

With 6 pcs nose pieces:
2.4mm(3/32"), 3.2mm(1/8"), 4.0mm(5/32"),
4.8mm(3/16"), 5.6mm(7/32"), 6.4mm(1/4")

2250g 10 pcs / 28.5 Kgs / 3.3 CUFT

NEW



Riveters

SC-710 Scissor Action Industrial Riveter

With 4 pcs nose pieces:
2.4mm(3/32"), 3.2mm(1/8"),
4.0mm(5/32"), 4.8mm(3/16")

With 40 pcs blind rivets:
2.4mm(*5), 3.2mm(*15), 4.0mm(*15), 4.8mm(*5)

2000g 10 pcs / 21 Kgs / 1.2 CUFT

- Suitable for construction and industrial applications
- Stretching design is suitable for use in difficult accessing area and gives large riveting force
- Made of durable high carbon steel



SC-714 Industrial Lever Riveter

With 4 pcs nose pieces:
3.2mm(1/8"), 4.0mm(5/32"),
4.8mm(3/16"), 6.4mm(1/4")

With 40 pcs blind rivets:
3.2mm(*10), 4.0mm(*10), 4.8mm(*10), 6.4mm(*10)

1400g 10 pcs / 15 Kgs / 1.3 CUFT

- Suitable for construction and industrial applications
- Gives large riveting force
- Aluminum body, steel tube with rubber handle



SC-736 Free Section Hand Riveter

With 4 pcs nose pieces:
2.4mm(3/32"), 3.2mm(1/8"),
4.0mm(5/32"), 4.8mm(3/16")

With 40 pcs blind rivets:
2.4mm(*5), 3.2mm(*15), 4.0mm(*15), 4.8mm(*5)

750g 24 pcs / 19 Kgs / 1.42 CUFT

- Suitable for construction and industrial applications
- Head rotates 360° for any angle riveting

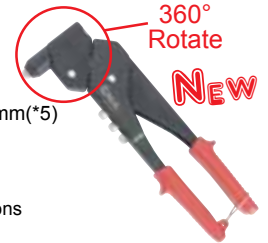

SC-715 Heavy Duty Hand Riveter Suitable For Stainless Steel Riveter

With 4 pcs nose pieces:
2.4mm(3/32"), 3.2mm(1/8"),
4.0mm(5/32"), 4.8mm(3/16")

With 40 pcs blind rivets:
2.4mm(*5), 3.2mm(*15), 4.0mm(*15), 4.8mm(*5)

580g 24 pcs / 15 Kgs / 1.1 CUFT

- Suitable for stainless steel riveter
- Chrome Molybdenum jaws, aluminum body and drop-forged handle



SC-GS701 Heavy Duty Hand Riveter

With 4 pcs nose pieces: 2.4mm(3/32"), 3.2mm(1/8"),
4.0mm(5/32"), 4.8mm(3/16")

With 40 pcs blind rivets: 2.4mm(*5), 3.2mm(*15),
4.0mm(*15), 4.8mm(*5)

580g 24 pcs / 15 Kgs / 1.1 CUFT

- Suitable for stainless steel riveter
- Chrome Molybdenum jaws, aluminum body and drop-forged handle



SC-758A Heavy Duty Hand Nut Riveter

With 4 pcs nose pieces: M3, M4, M5, M6
With 40 pcs nut rivets: M3(*10), M4(*10),
M5(*10), M6(*10)

800g 24 pcs / 20.5 Kgs / 1.45 CUFT

- Aluminum body and drop-forged handle



Disc Brake Calipers

AT-08 11pcs Disc Brake Caliper Tool Set

- 7 Rear Disc Brake Caliper Adapters:
 - 32mm(1 1/4") -
 - 42mm(1 5/8") Long Pin -
 - 42mm(1 5/8") Short Pin -
 - 1 7/8"(43mm) - 2"(51mm) -
 - 2 1/8"(54mm) - 2 1/2"(63mm)
- 1 Front Disc Brake Caliper Adapters:
 - 55mm(2 3/16")
- 2 Accessory:
 - Plate -
 - Pusher Screw Handle (R)



2100g 10 Sets / 22 Kgs / 2.2 CUFT

- Jack up the car and support on axle stands, Then remove the relevant road wheel
- Remove the caliper from its carrier and take out the brake pads
- Fit the main body of the wind back tool into the caliper, turn the main thrust bolt clockwise to compensate for the distance between the position and caliper body
- Select the correct adapter and fit it to the end of the main thrust bolt, continue rotating into the mating recesses in the piston
- Turn the thrust bolt to wind the caliper piston back into its housing
- Fit the new break pads and bolt the caliper back into the carrier

AT-BC08 11pcs Brake Piston Wind Back Set

- 1 Handle (R) 1 Plate
- 9 Adapters:
 - 32mm(1 1/4") (2 Pins□ = 5mm)
 - 36mm(1 7/16") (2 Pins□ = 4mm)
 - 36mm(1 7/16") (2 Pins□ = 6.35mm)
 - 42mm(1 5/8") (2 Pins□ = 6mm)
 - 46mm(1 13/16") (2 Pins□ = 5mm)
 - 36mm(1 7/16") (1 Sq. Pin□ = 8mm)
 - 46mm(1 13/16") (1 Sq. Pin□ = 8mm)
 - 48mm(1 7/8") (2 Sq. Pins□ = 11mm)
 - 55mm(2-3/16")



2000g 4 Sets / 9 Kgs / 0.85 CUFT

Designed for most:

Alfa - Audi - BMW - Fiat - Ford - GM - Honda - Jaguar - Mercedes - Mazda - Nissan - Peugeot - Rover - Saab - Toyota - VW

AT-BC18 18pcs Master Universal Caliper Wind Back Set

- 2 Handle (L) & (R) 1 Plate
- 15 Adapters:
 - 32mm(1 1/4") (12mm Male Hex)
 - 30mm(1 3/16") (2 Pins□ = 4mm)
 - 32mm(1 1/4") (2 Pins□ = 4mm)
 - 32mm(1 1/4") (2 Pins□ = 5.5mm)
 - 32mm(1 1/4") (2 Short Pins□ = 5mm)
 - 42mm(1 5/8") (2 Short Pins□ = 6mm)
 - 42mm(1 5/8") (2 Long Pins□ = 6mm)
 - 42mm(1 5/8") (4 Pins□ = 5mm)
 - 47mm(1 7/8") (1 Pin□ = 5.5mm)
 - 51mm(2") (1Long 2Short Pin□ = 6mm)
 - 54mm(2 1/8") (1 Pin□ = 5.5mm)
 - 54mm(2 1/8") (2 Pins□ = 8mm)
 - 63mm(2 1/2") (1 Pin□ = 5.5mm)
 - 55mm(2-3/16")
 - 3/8" Square Dr. (2 Pins□ = 6mm)



2500g 4 Sets / 11 Kgs / 1.07 CUFT

Designed for most:

Audi - BMW - Citroen - Fiat - Ford - GM - Honda - Isuzu - Jaguar - Mercedes - Mazda - Nissan - Peugeot - Rover - Saab - Subaru - Toyota - Volvo - VW

Spring Compressor Set

AT-SC230 2pcs Spring Compressor Set

- Designed for work on regular or MacPherson Strut assemblies
- Fits 3/8" Dr. Ratchet or Air Impact Wrench
- Length: 300mm

color box
1670g 12 Sets / 21 Kgs / 1 CUFT



Inner Tie Rod

AT-4808 8pcs Inner Tie Rod Tool Set

- 7 Open Jaw Drivers:
 - 14 - 17 - 33.6mm
 - 1 3/16 - 1 1/4 - 1 5/16 - 1 7/16"
- 1 Long Socket

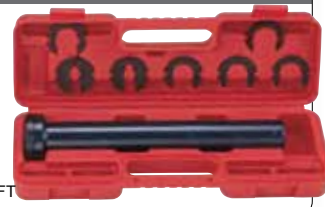

2400g 6 Sets / 15.5 Kgs / 1.35 CUFT

These tools are specially designed for the inner tie rods that are inaccessible to adjust. The long socket can be easily used with seven open-jaw drivers, size 1-3/16", 1-1/4", 1-5/16", 1-7/16", 14mm, 17mm and 33.6mm, to most application. The inner tie rod can be easily removed and installed by slipping the long socket over the tie rod end and connecting it to the open-jaw driver.

Valve Spring Compressor

AT-09 9pcs Valve Spring Compressor Set

- 1 "C" Clamp: 250mmL (10"L)
- 5 Driving Adapters:
 - 16 - 19 - 23 - 25 - 30mm
- 2 Pressure Screws:
 - 70 - 110mmL



2000g 4 Sets / 9 Kgs / 1 CUFT

These tools are designed to compress and release valve springs. After removal of collects, pantograph-type levers ensure a consistent coaxial contact with the valve. They work efficiently on all automobiles, trucks and tractor motors.

Ball Joints

AT-0914 14pcs Ball Joint Adapter Set

Description	O.D.	I.D.	Length
9 Receiving Tube	2 1/4"	2"	2"
Receiving Tube	2 1/2"	2 1/4"	1 1/2"
Receiving Tube	2 1/4"	1 7/8"	7/16"
Receiving Tube	2 1/2"	2 1/4"	3/4"
Receiving Tube	2 1/2"	2 1/4"	2 3/4"
Receiving Tube	3"	2 3/4"	2 1/4"
Receiving Tube	2 3/4"	2 7/16"	2 1/4"
Receiving Tube	2 7/8"	2 5/8"	2 7/8"
Receiving Tube	2 7/16"	2 3/16"	3 3/16"
2 Installing Tube	2"	1 3/4"	2 5/16"
Installing Tube	2"	1 3/4"	3"
1 Receiving Cup	2 1/8"	1 3/4"	1/2"
1 Plug	7/8"		
1 Remover/Installer	1 7/16"	3/4"	1"



5300g 3 Sets / 17 Kgs / 1.6 CUFT

- A complete ball joint adapter set
- Includes all the receive tubes and removing/installing adapters needed to work on most GM, Ford and Dodge two and four-wheel drive pickups, vans and sport utility vehicles through 2002. Application chart included
- Works on press-fit upper and lower ball joints
- Set also includes a live center forcing screw plug

AT-7207 7pcs Ball Joint Removal & Installing Set

- 3 Receiving Tubes
- 1 Forcing Screw
- 1 Removing Adapter
- 1 Installing Adapter
- 1 C-Frame



7000g 2 Sets / 15 Kgs / 0.92 CUFT

Belt Tensioning Wrenches

AT-BW08 8pcs Belt Tensioning Wrench Set

- 5 Sockets: 13 - 14 - 15 - 16 - 18mm
- 2 Adapters: 3/8" & 1/2"Dr.
- 1 Handle: 15mm Hex Ratcheting Wrench



1050g 20 Sets / 22.4 Kgs / 2.1 CUFT

AT-BW15 15pcs Belt Tensioning Wrench Set

- 9 Socket: 8 - 12 - 13 - 14 - 15 - 16 - 17 - 18mm (6pt.) Socket: 24mm (12pt.)
- 2 Adapters: 3/8" & 1/2"Dr.
- 3 Bit Adapter: 1/4"x5/16" - 5/16"x5/16" - 10mmx5/16" Hex Shank
- 1 Handle: 15mm Hex Ratcheting Wrench



1680g 12 Sets / 21.1 Kgs / 1.8 CUFT

Oil Filter Wrenches

Three-Legged Oil Filter Wrench

ITEM NO.	Capacity mm (Inch)
AT-B01	75~125 (3" ~ 5")

- Fits 3/8" Dr. ratchet
- Grooved legs generate more gripping power



Oil Filter Locking Pliers

ITEM NO.	Length mm (Inch)
AT-OF10A	250 (10")

- Jaw Opening: 2-1/8"~4-5/8" (53~118mm)



NEW

Heavy Duty Oil Filter Pliers

ITEM NO.	Capacity mm (Inch)	Length mm (Inch)
AT-OF10	60~90 (2-3/8 ~ 3-1/2")	250 (10")
AT-OF12	50 ~ 115 (2" ~ 4-1/2")	300 (12")

- 3 Position Adjustable



Swivel Handle Oil Filter Wrenches

ITEM NO.	Diameter mm (Inch)	Capacity mm (Inch)
AT-BOF2	60~73 (2-3/8 ~ 2-7/8")	
AT-BOF3	73~85 (2-7/8 ~ 3-3/8")	
AT-BOF4	85~95 (3-3/8 ~ 3-3/4")	
AT-BOF5	95~100 (3-3/4 ~ 4-3/8")	

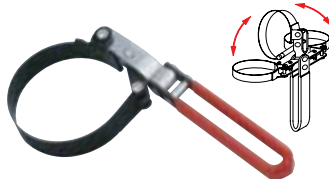

Extractors

Taper Bit Extractors

ITEM NO.	Capacity mm (Inch)	Length mm
010603	3 (1/8")	60
010705	5 (3/16")	70
010756	6 (15/64")	75
010808	8 (5/16")	80
010859	9 (3/8")	85
011012	12 (15/32")	105
011214	14 (9/16")	125
011316	16 (21/32")	130



AT-EX5 5pcs Taper Bit Extractor Set

- 5 Taper Bit Extractors: (010603 ~ 010859)
 - 3mm (1/8") - 5mm (3/16") -
 - 6mm (15/64") - 8mm (5/16") -
 - 9mm (3/8")



140g 120 Sets / 17.5 Kgs / 0.92 CUFT

Extractors

AT-EX6 6pcs Screw Extractor Set

- 6 Screw Extractors
 - No.1 3~6mm (1/8~1/4") -
 - No.2 6~8mm (1/4~5/16") -
 - No.3 8~11mm (5/16~7/16") -
 - No.4 11~14mm (7/16~9/16") -
 - No.5 14~19mm (9/16~3/4") -
 - No.6 19~25mm (3/4~1")

Plastic Case 250g 40 Sets / 11 Kgs / 0.71 CUFT



Hose Clamp Drivers

ITEM NO.	Size mm	Length mm
596+0146	6	280
596+0147	7	280
596+0148	8	280
596+0150	10	280



6 DL

Heater Hose Clamp Pliers



ITEM NO.	Length mm (Inch)
AT-HC10	220 (8.7")



ITEM NO.	Length mm (Inch)
AT-HC12	220 (8.7")



ITEM NO.	Length mm (Inch)
AT-HC14	220 (8.7")

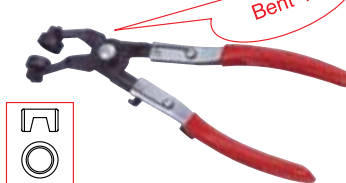

ITEM NO.	Length mm (Inch)
AT-HC16	230 (9.1")

Wheel Balancing Weight Tools

ITEM NO.	Size Inch	Length mm
560425	10"	250

- Designed for fitting and removing wheel balancing weights
- Chrome Vanadium Steel
- Phosphatised finish



Magnetic Fender Covers

ITEM NO.	Size mm	Weight g
FC-086	800 x 600	670
FC-116	1050 x 580	920



FC-086



NEW

Automotive Tools

Rigid Carbon Scrapers



ITEM NO.	Blade Style	Blade Width	Overall Length
595212	Straight	12mm	250mm

ITEM NO.	Blade Style	Blade Width	Overall Length
595226	Straight	26mm	200mm



ITEM NO.	Blade Style	Blade Width	Overall Length
595232	Straight	26mm	300mm

Trim Pad Remover

ITEM NO.	Length mm (Inch)
AT-TPR	230 (9.1")



Brake Spring Pliers

ITEM NO.	Length mm (Inch)
AT-BSP	330 (13")



Miniature Awls, Hooks & Picks



ITEM NO.	Type	Blade Length	Overall Length
592801	Awl	75mm	150mm

ITEM NO.	Type	Blade Length	Overall Length
592802	Hook	75mm	150mm



ITEM NO.	Type	Blade Length	Overall Length
592803	45° Tip	75mm	150mm

ITEM NO.	Type	Blade Length	Overall Length
592804	90° Tip	75mm	150mm

PK-AHP4 4pcs Miniature Pick Set

- 1 Mini-Awl (592801)
- 1 Mini-Hook (592802)
- 1 Mini-Bent Tip 45° (592803)
- 1 Mini-Bent Tip 90° (592804)



130g 80 Sets / 11.5 Kgs / 1.8 CUFT

PK-OSP4 2pcs O-Ring Oil Seal Pick Set

- 1 Hook & O-Ring 90° Tip (Double End)
- 1 Bent Tip 90° & Bent Tip 45° (Double End)



40g 300 Sets / 12.5 Kgs / 2.7 CUFT

Grease Gun

AT-46012 Grease Gun

- 1 Grease Gun
- 1 Flexible Pipe
- 1 Rigid Pipe



1200g 20 Sets / 26.9 Kgs / 2.3 CUFT

- Standard 14 oz. cartridge
- Pressure filler
- Bulk 400 c.c.

Hinged Mirrors



ITEM NO.	Description
AT-RM15	50mm x 90mm

ITEM NO.	Description
AT-RM14	57mm Diameter

Magnetic Tools



Magnetic Pick-Up Tool

ITEM NO.	Length mm (Inch)
AT-PU22	215 (8.5")

Magnetic Pick-Up Tool

ITEM NO.	Length mm (Inch)
AT-PU33	330~685 (13~27")



Magnetic Pick-Up Tool

ITEM NO.	Length mm (Inch)
AT-B16	135~645 (5.3 ~25.4")

Flexible Magnetic Pick-Up Tool

ITEM NO.	Length mm
AT-B24	600

Magnetic Parts Trays

ITEM NO.	Description
a. 001036	Single - 150D x 40H
b. 002034	Double - 237L x 137W x 40H
c. 003047	Triple - 360L x 160W x 40H
d. 004048	Quad - 295L x 275W x 40H



Magnetic Bar Tool Holders

ITEM NO.	Length mm (Inch)
005012	305 (12")
005016	405 (16")
005024	610 (24")



Socket Holders



Plastic Socket Holders

ITEM NO.	Drive Size
001002	1/4"
001003	3/8"
001004	1/2"
001006	3/4"

Socket Rails with Clips

ITEM NO.	Drive Size	Length mm	Clips pcs	Pack of
010152	1/4"	410	15	2
010153	3/8"	480	15	2
010154	1/2"	560	15	2
010156	3/4"	560	10	2

Tool Storage

TS-244 4 Drawer Top Chest

	Width	Depth	Height
Overall	655mm (25.8")	450mm (17.7")	390mm (15.4")
3 Drawer	572mm (22.5")	410mm (16.1")	41mm (1.6")
1 Drawer	572mm (22.5")	410mm (16.1")	60mm (2.4")

31.5 kgs 1 Set / 34 Kgs / 5.9 CUFT



Add-on for
• TS-465
• TS-465P
• TS-467
• TS-467P

Tool Storage



TS-125 5 Tier Portable Tool Chest

	Width	Depth	Height
Overall	536mm (21.1")	258mm (10.2")	220mm (8.6")
4 Drawer	530mm (20.8")	125mm (5")	50mm (2")
1 Drawer	530mm (20.8")	253mm (10")	88mm (3.5")

6.5 kgs 1 Set / 7.5 Kgs / 2 CUFT



DS-424 1/2" Dr. Sockets Display Stand

	Width	Depth	Height
Overall	425mm (16.7")	340mm (13.4")	315mm (12.4")

• Suitable for Shallow and Deep Sockets
• Stickers included: 8~32mm & 5/16~1-1/4"

5900 g 1 Set / 6.3 Kgs / 0.54 CUFT



TS-465 5 Drawer Roller Cabinet

	Width	Depth	Height
Overall	686mm (27")	466mm (18.3")	666mm (26.2")
3 Drawer	581mm (22.8")	410mm (16.1")	60mm (2.4")
2 Drawer	581mm (22.8")	410mm (16.1")	140mm (5.5")

53.5 kgs 1 Set / 57 Kgs / 9.8 CUFT

TS-465P (w/ Top Tray) 5 Drawer Roller Cabinet

	Width	Depth	Height
Overall	686mm (27")	466mm (18.3")	666mm (26.2")
3 Drawer	581mm (22.8")	410mm (16.1")	60mm (2.4")
2 Drawer	581mm (22.8")	410mm (16.1")	140mm (5.5")
Top Tray	890mm (35")	510mm (20.1")	45mm (1.8")

62 kgs 1 Set / 64.5 Kgs / 14 CUFT



TS-467 7 Drawer Roller Cabinet

	Width	Depth	Height
Overall	686mm (27")	466mm (18.3")	820mm (32.3")
5 Drawer	581mm (22.8")	410mm (16.1")	60mm (2.4")
2 Drawer	581mm (22.8")	410mm (16.1")	140mm (5.5")

65 kgs 1 Set / 69 Kgs / 11.5 CUFT

TS-467P (w/ Top Tray) 7 Drawer Roller Cabinet

	Width	Depth	Height
Overall	686mm (27")	466mm (18.3")	820mm (32.3")
5 Drawer	581mm (22.8")	410mm (16.1")	60mm (2.4")
2 Drawer	581mm (22.8")	410mm (16.1")	140mm (5.5")
Top Tray	890mm (35")	510mm (20.1")	45mm (1.8")

70 kgs 1 Set / 75 Kgs / 15 CUFT



TS-123 3 Drawer Tool Chest

	Width	Depth	Height
Overall	575mm (22.5")	230mm (9")	311mm (12.2")
3 Drawer	503mm (19.8")	193mm (7.6")	45mm (1.7")

10.5 kgs 1 Set / 13.5 Kgs / 1.9 CUFT



TS-797 7 Drawer Side Cabinet

	Width	Depth	Height
Overall	380mm (15")	460mm (18.1")	798mm (31.4")
5 Drawer	291mm (11.5")	410mm (16.1")	56mm (2.2")
2 Drawer	291mm (11.5")	410mm (16.1")	122mm (4.8")

37 kgs 1 Set / 40 Kgs / 7.5 CUFT



TS-790 10 Drawer Top Chest

	Width	Depth	Height
Overall	660mm (26")	455mm (17.9")	483mm (19")
6 Drawer	169mm (6.7")	410mm (16.1")	45mm (1.8")
2 Drawer	576mm (22.7")	410mm (16.1")	45mm (1.8")
1 Drawer	169mm (6.7")	410mm (16.1")	122mm (4.8")
1 Drawer	576mm (22.7")	410mm (16.1")	56mm (2.2")

52 kgs 1 Set / 57 Kgs / 8.5 CUFT



TS-798 7 Drawer Roller Cabinet

	Width	Depth	Height
Overall	670mm (26.4")	460mm (18.1")	813mm (32")
5 Drawer	576mm (22.7")	410mm (16.1")	56mm (2.2")
2 Drawer	576mm (22.7")	410mm (16.1")	122mm (4.8")

64 kgs 1 Set / 72 Kgs / 12.5 CUFT

Add-on for
• TS-798

Tool Storage

Jumbo Tool Storage



Add-on for
•TS-468



Double Brakes

TS-246
6 Drawer Top Chest

	Width	Depth	Height
Overall	968mm (38")	450mm (18")	600mm (24")
4 Drawer	877mm (35")	410mm (16.1")	54mm (2.1")
2 Drawer	877mm (35")	410mm (16.1")	100mm (3.9")

59.5 kgs 1 Set / 64.5 Kgs / 13.3 CUFT

TS-468
7 Drawer Roller Cabinet

	Width	Depth	Height
Overall	980mm (39")	463mm (18")	820mm (32.3")
5 Drawer	877mm (35")	410mm (16.1")	60mm (2.4")
2 Drawer	877mm (35")	410mm (16.1")	124mm (4.9")

86 kgs 1 Set / 94 Kgs / 17 CUFT



Add-on for
•TS-796



Add-on for
•TS-796

TS-710
6 Drawer Top Chest

	Width	Depth	Height
Overall	806mm (32")	484mm (19")	540mm (21")
5 Drawer	734mm (29")	422mm (17")	40mm (1.6")
1 Drawer	734mm (29")	422mm (17")	90mm (3.5")

73 kgs 1 Set / 76.5 Kgs / 9.7 CUFT

TS-796
8 Drawer Side Cabinet

	Width	Depth	Height
Overall	506mm (20")	495mm (19.5")	920mm (36")
3 Drawer	390mm (15")	422mm (17")	45mm (1.8")
3 Drawer	390mm (15")	422mm (17")	85mm (3.4")
2 Drawer	390mm (15")	422mm (17")	140mm (5.5)

63 kgs 1 Set / 68 Kgs / 11 CUFT

TS-796
8 Drawer Roller Cabinet

	Width	Depth	Height
Overall	850mm (33")	495mm (19.5")	946mm (37")
3 Drawer	734mm (29")	422mm (17")	45mm (1.8")
3 Drawer	734mm (29")	422mm (17")	85mm (3.4")
2 Drawer	734mm (29")	422mm (17")	140mm (5.5")

138 kgs 1 Set / 152 Kgs / 18.7 CUFT



Tool Storage

TS-764
Roll Cart with 4 Drawers

	Width	Depth	Height
Overall	778mm (31")	512mm (20")	888mm (35")
2 Drawer	298mm (12")	434mm (17")	89mm (3.5")
1 Drawer	625mm (25")	434mm (17")	89mm (3.5")
1 Drawer	625mm (25")	434mm (17")	137mm (5.4")

65.5 kgs 1 Set / 71.5 Kgs / 10.9 CUFT



TS-768
Roll Cart with 5 Drawers

	Width	Depth	Height
Overall	1240mm (49")	517mm (20")	888mm (35")
4 Drawer	528mm (21")	445mm (18")	89mm (3.5")
1 Drawer	1088mm (43")	445mm (18")	120mm (4.7")

95 kgs 1 Set / 103 Kgs / 15.5 CUFT

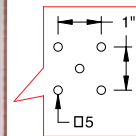

DS-111
Display Stand

	Width	Depth	Height
Overall	945mm (37")	400mm (16")	2245mm (88")

41 kgs 1 Set / 50 Kgs / 4.99 CUFT



DS-038B
Display Stand

	Width	Depth	Height
Overall	945mm (37")	400mm (16")	2245mm (88")

55 kgs 1 Set / 60 Kgs / 7.17 CUFT

WS-759
Multi-Function Workstation Set

	Width	Depth	Height
Overall	1530mm (60.2")	706mm (27.8")	1590mm (62.6")
2 Drawer	569mm (22.4")	275mm (10.8")	41mm (1.6")
1 Drawer	569mm (22.4")	275mm (10.8")	64mm (2.5")
2 Cabinet	400mm (15.7")	200mm (7.9")	500mm (19.7")

103 kgs 1 Set / 109 Kgs / 15.1 CUFT



Accessory:

- Cutting Board W 1500mm(59") x D 700mm(27.5") x H 6mm(0.24")
- 4 Sets Adjustable Device
- 10pcs Single Hooks
- 10pcs Double Hooks
- 10pcs U Shape Hooks

1/6 Tray Sets

IS-314M 14pcs 3/8" Dr. Metric Impact Socket Set

- 13 6pt. Socket 8 - 9 - 10 - 11 - 12 - 13 - 14 - 15 - 16 - 17 - 18 - 19 - 21mm
- 1 Extension 75mmL



6 pt.

1/6 Tray 960g 10 Sets / 10.5 Kgs / 0.93 CUFT

IS-415M 15pcs 1/2" Dr. Metric Impact Socket Set

- 14 6pt. Socket 10 - 11 - 12 - 13 - 14 - 15 - 16 - 17 - 18 - 19 - 21 - 22 - 23 - 24mm
- 1 Extension 125mmL



6 pt.

1/6 Tray 1830g 10 Sets / 19.5 Kgs / 0.93 CUFT

Deep DI-415M 15pcs 1/2" Dr. Metric Deep Thin Wall Impact Socket Set

- 15 6pt. Thin Wall Socket 10 - 11 - 12 - 13 - 14 - 15 - 16 - 17 - 18 - 19 - 20 - 21 - 22 - 23 - 24mm



6 pt.

1/6 Tray 2100g 10 Sets / 22 Kgs / 0.93 CUFT

Deep DI-407M 7pcs 1/2" Dr. Metric Spindle Nut Impact Socket Set

- 7 6pt. Deep Socket 30 - 32 - 33 - 34 - 35 - 36 - 38mm



6 pt.

1/6 Tray 3750g 6 Sets / 24 Kgs / 0.94 CUFT

Deep DI-407S 7pcs 1/2" Dr. SAE Spindle Nut Impact Socket Set

- 7 6pt. Deep Socket 1 1/8 - 1 3/16 - 1 1/4 - 1 5/16 - 1 3/8 - 1 7/16 - 1 1/2"



6 pt.

1/6 Tray 3750g 6 Sets / 24 Kgs / 0.94 CUFT

IE-2349 9pcs 1/4, 3/8 & 1/2" Dr. Impact Extension Bar Set

- 3 1/4" Dr. Impact Ext. 50 - 100 - 150mmL
- 3 3/8" Dr. Impact Ext. 45 - 75 - 150mmL
- 3 1/2" Dr. Impact Ext. 50 - 125 - 250mmL

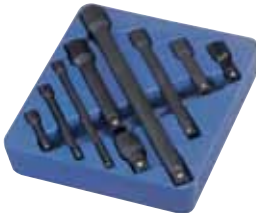

1/6 Tray 1400g 10 Sets / 15 Kgs / 0.93 CUFT

Deep GS-222M 22pcs 1/4" Dr. Metric Deep Hand Socket Set

- 10 6pt. Socket 5 - 5.5 - 6 - 7 - 8 - 9 - 10 - 11 - 12 - 13mm
- 8 6pt. Deep Socket 6 - 7 - 8 - 9 - 10 - 11 - 12 - 13mm
- 1 Universal Joint 1 Ext. 50mmL
- 1 Socket Driver 1 Quick Release Ratchet



6 pt.

1/6 Tray 930g 10 Sets / 10 Kgs / 0.93 CUFT

1/6 Tray Sets

Deep TW-230M 30pcs 1/4" Dr. Metric Deep Hand Socket Set

- 11 12pt. Socket 5 - 5.5 - 6 - 7 - 8 - 9 - 10 - 11 - 12 - 13 - 14mm
- 12 6pt. Deep Socket 4 - 5 - 5.5 - 6 - 7 - 8 - 9 - 10 - 11 - 12 - 13 - 14mm
- 1 Universal Joint 3 Ext. 50 - 100 - 150mmL
- 1 Sliding T-Handle 1 Quick Release Ratchet
- 1 Socket Driver



6 pt.

12 pt.

1/6 Tray 1220g 10 Sets / 13.5 Kgs / 0.93 CUFT

TW-227MS 27pcs 1/4" Dr. Metric & SAE Hand Socket Set

- 11 12pt. Socket 5 - 5.5 - 6 - 7 - 8 - 9 - 10 - 11 - 12 - 13 - 14mm
- 10 12pt. Socket 3/16 - 7/32 - 1/4 - 9/32 - 5/16 - 11/32 - 3/8 - 7/16 - 1/2 - 9/16"
- 1 Universal Joint 2 Ext. 50 - 150mmL
- 1 Sliding T-Handle 1 Quick Release Ratchet
- 1 Socket Driver



12 pt.

1/6 Tray 1000g 10 Sets / 11 Kgs / 0.93 CUFT

EX-2349 9pcs 1/4, 3/8 & 1/2" Dr. Extension Bar Set

- 3 1/4" Dr. Ext. 50 - 100 - 150mmL
- 3 3/8" Dr. Ext. 45 - 75 - 150mmL
- 3 1/2" Dr. Ext. 50 - 125 - 250mmL



1/6 Tray 1170g 10 Sets / 13 Kgs / 0.93 CUFT

BE-2349 9pcs 1/4, 3/8 & 1/2" Dr. Wobble Extension Bar Set

- 3 1/4" Dr. Wobble Ext. 50 - 100 - 150mmL
- 3 3/8" Dr. Wobble Ext. 45 - 75 - 150mmL
- 3 1/2" Dr. Wobble Ext. 50 - 125 - 250mmL



1/6 Tray 1170g 10 Sets / 13 Kgs / 0.93 CUFT

TX-412 12pcs 1/2" Dr. Bit Socket Set

- 4 1/2" Dr. Hex: 5mm(190mmL) & 6 - 7 - 8mm(110mmL)
- 4 1/2" Dr. Star: T40 - 45 - 55(110mmL) & T70(150mmL)
- 4 1/2" Dr. Triple Square: M6 - 8 - 10 - 12(110mmL)



1/6 Tray 1570g 10 Sets / 17 Kgs / 0.93 CUFT

OW-707M 7pcs Metric Open End Wrench Set

- 7 Open End Wrenches: 6x7 - 8x9 - 10x11 - 12x13 - 14x15 - 16x17 - 18x19mm



1/6 Tray 810g 10 Sets / 9.5 Kgs / 0.93 CUFT

OW-705S 5pcs SAE Open End Wrench Set

- 5 Open End Wrenches: 1/4x5/16 - 3/8x7/16 - 1/2x9/16 - 5/8x11/16 - 3/4x7/8"



1/6 Tray 720g 10 Sets / 8.5 Kgs / 0.93 CUFT



Tool Trays

1/6 Tray Sets

TX-2324 24pcs Star Wrench Set

- 4 E-Star Wrench: E6xE8 - E10xE12 - E14xE18 - E20xE24
- 7 3/8" Dr. E-Star Hand Socket: E10 - 11 - 12 - 14 - 16 - 18 - 20
- 10 Tamperproof Star Bit: T8 ~ T50 (30mmL)
- 3 Bit Holder: 1/4"Dr.x1/4" - 3/8"Dr.x1/4" - 3/8"Dr.x5/16"



1/6 Tray  980g  10 Sets / 11 Kgs / 0.93 CUFT

CW-404MS 4pcs 1/2" Dr. Metric & SAE Car Wheel Thin Wall Impact Socket Set

- 3 6pt. Thin Wall Socket w/ Plastic Sleeve 17 - 19 - 21mm
- 1 6pt. Thin Wall Socket w/ Plastic Sleeve 13/16"



1/6 Tray  1170g  10 Sets / 13 Kgs / 0.93 CUFT

CW-406M 6pcs 1/2" Dr. Metric Car Wheel COLOUR MATCH® Set

- 3 6pt. Thin Wall Socket w/ Plastic Sleeve 17 - 19 - 21mm
- 3 Torque Extension Bar 80 ft.lb.(110Nm) - 90 ft.lb.(120Nm) - 110 ft.lb.(150Nm) -



1/6 Tray  1500g  10 Sets / 16 Kgs / 0.93 CUFT

RP-5504 4pcs Retaining Ring Pliers Set

- 1 Straight Nose, External (550750)
- 1 Straight Nose, Internal (550751)
- 1 90° Bent Nose, External (550752)
- 1 90° Bent Nose, Internal (550753)



1/6 Tray  830g  10 Sets / 9.5 Kgs / 0.93 CUFT

FEATURES:

Customize your drawer layout to your own personal style and need with durable plastic trays, they make storing and retrieving tools fast and easy. Always find the tools you need in an instant, like a professional is expected to be.

There are five interchangeable sizes (1/6, 1/3, 1/2, 2/3, full size) to choose from. For the best fit, use with Genius Tools' brand tool chests.

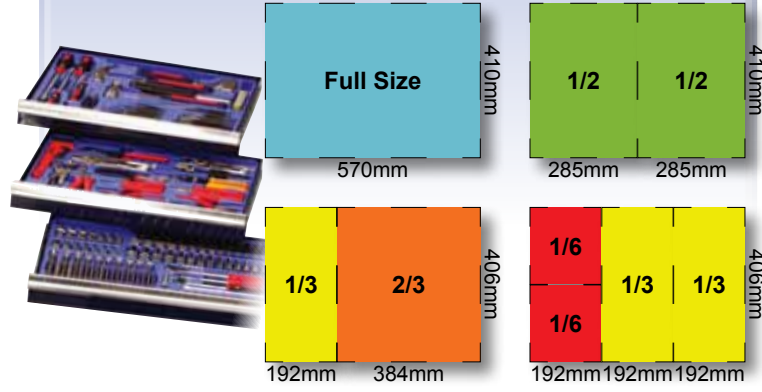



1/3 Tray Sets

TF-332M 32pcs 3/8" Dr. Metric Deep Impact Socket Set (CR-V)

- 16 6pt. Socket 7 - 8 - 9 - 10 - 11 - 12 - 13 - 14 - 15 - 16 - 17 - 18 - 19 - 20 - 21 - 22mm
- 16 6pt. Deep Socket 7 - 8 - 9 - 10 - 11 - 12 - 13 - 14 - 15 - 16 - 17 - 18 - 19 - 20 - 21 - 22mm





1/3 Tray  3650g  5 Sets / 19.5 Kgs / 0.93 CUFT

CM-332M 32pcs 3/8" Dr. Metric Deep Impact Socket Set (CR-Mo)

- 16 6pt. Socket 7 - 8 - 9 - 10 - 11 - 12 - 13 - 14 - 15 - 16 - 17 - 18 - 19 - 20 - 21 - 22mm
- 16 6pt. Deep Socket 7 - 8 - 9 - 10 - 11 - 12 - 13 - 14 - 15 - 16 - 17 - 18 - 19 - 20 - 21 - 22mm





1/3 Tray  3450g  5 Sets / 18 Kgs / 0.93 CUFT

TF-425M 25pcs 1/2" Dr. Metric Impact Socket Set (CR-V)

- 25 6pt. Socket 8 - 9 - 10 - 11 - 12 - 13 - 14 - 15 - 16 - 17 - 18 - 19 - 20 - 21 - 22 - 23 - 24 - 25 - 26 - 27 - 28 - 29 - 30 - 31 - 32 mm





1/3 Tray  3700g  3 Sets / 13 Kgs / 0.82 CUFT

TF-425MD 25pcs 1/2" Dr. Metric Deep Impact Socket Set (CR-V)

- 25 6pt. Deep Socket 8 - 9 - 10 - 11 - 12 - 13 - 14 - 15 - 16 - 17 - 18 - 19 - 20 - 21 - 22 - 23 - 24 - 25 - 26 - 27 - 28 - 29 - 30 - 31 - 32mm





1/3 Tray  6200g  3 Sets / 20 Kgs / 0.82 CUFT

IS-425M 25pcs 1/2" Dr. Metric Impact Socket Set (CR-Mo)

- 25 6pt. Socket 8 - 9 - 10 - 11 - 12 - 13 - 14 - 15 - 16 - 17 - 18 - 19 - 20 - 21 - 22 - 23 - 24 - 25 - 26 - 27 - 28 - 29 - 30 - 32 - 36mm





1/3 Tray  4000g  3 Sets / 13 Kgs / 0.82 CUFT

DI-425M 25pcs 1/2" Dr. Metric Deep Impact Socket Set (CR-Mo)

- 25 6pt. Deep Socket 8 - 9 - 10 - 11 - 12 - 13 - 14 - 15 - 16 - 17 - 18 - 19 - 20 - 21 - 22 - 23 - 24 - 25 - 26 - 27 - 28 - 29 - 30 - 32 - 36mm





1/3 Tray  7000g  3 Sets / 22 Kgs / 0.82 CUFT

IS-422S 22pcs 1/2" Dr. SAE Impact Socket Set (CR-Mo)

- 22 6pt. Socket 5/16 - 3/8 - 7/16 - 1/2 - 9/16 - 19/32 - 5/8 - 11/16 - 3/4 - 25/32 - 13/16 - 7/8 - 15/16 - 1" - 1 1/16 - 1 1/8 - 1 3/16 - 1 1/4 - 1 5/16 - 1 3/8 - 1 7/16 - 1 1/2"





1/3 Tray  4330g  3 Sets / 14 Kgs / 0.82 CUFT

DI-422S 22pcs 1/2" Dr. SAE Deep Impact Socket Set (CR-Mo)

- 22 6pt. Deep Socket 5/16 - 3/8 - 7/16 - 1/2 - 9/16 - 19/32 - 5/8 - 11/16 - 3/4 - 25/32 - 13/16 - 7/8 - 15/16 - 1" - 1 1/16 - 1 1/8 - 1 3/16 - 1 1/4 - 1 5/16 - 1 3/8 - 1 7/16 - 1 1/2"



1/3 Tray  6700g  3 Sets / 21 Kgs / 0.82 CUFT

1/3 Tray Sets

deep DI-417MD 17pcs 1/2" Dr. Metric Deep Thin Wall Impact Socket Set

- 17 12pt. Deep Thin Wall Socket
8 - 9 - 10 - 11 - 12 - 13 - 14 -
15 - 16 - 17 - 18 - 19 - 20 -
21 - 22 - 23 - 24mm



12 pt.

1/3 Tray
3340g 5 Sets / 18 Kgs / 0.93 CUFT

deep EU-335M 35pcs 3/8" Dr. Metric Deep Hand Socket Set

- 15 12pt. Skt. 7 - 8 - 9 - 10 - 11 - 12 - 13 - 14 - 15 - 16 - 17 - 18 - 19 - 21 - 22mm
- 15 6pt. Deep Socket 7 - 8 - 9 - 10 - 11 -
12 - 13 - 14 - 15 - 16 - 17 - 18 -
19 - 21 - 22mm
- 1 Universal Joint 1 Sliding T-Handle
- 2 Ext. 150 - 250mL
- 1 Quick Release Ratchet



6 pt.

12 pt.

1/3 Tray
3470g 5 Sets / 18.5 Kgs / 0.93 CUFT

deep GS-330S 30pcs 3/8" Dr. SAE Deep Hand Socket Set

- 13 12pt. Socket 1/4 - 5/16 - 11/32 - 3/8 - 7/16 - 1/2 - 9/16 - 19/32 - 5/8 - 11/16 -
3/4 - 13/16 - 7/8"
- 12 6pt. Deep Socket 1/4 - 5/16 - 11/32 -
3/8 - 7/16 - 1/2 - 9/16 - 5/8 - 11/16 -
3/4 - 13/16 - 7/8"
- 1 Universal Joint 1 Sliding T-Handle
- 2 Ext. 150 - 250mL
- 1 Quick Release Ratchet



6 pt.

12 pt.

1/3 Tray
3110g 5 Sets / 17 Kgs / 0.93 CUFT

SS-425M 25pcs 1/2" Dr. Metric Hand Socket Set

- 25 6pt. Socket
8 - 9 - 10 - 11 - 12 - 13 - 14 - 15 -
16 - 17 - 18 - 19 - 20 - 21 - 22 -
23 - 24 - 25 - 26 - 27 - 28 - 29 -
30 - 32 - 36mm



6 pt.

1/3 Tray
3500g 3 Sets / 12 Kgs / 0.82 CUFT

deep DS-425M 25pcs 1/2" Dr. Metric Deep Hand Socket Set

- 25 6pt. Deep Socket
8 - 9 - 10 - 11 - 12 - 13 - 14 - 15 -
16 - 17 - 18 - 19 - 20 - 21 - 22 -
23 - 24 - 25 - 26 - 27 - 28 - 29 -
30 - 32 - 36mm



6 pt.

1/3 Tray
7000g 3 Sets / 22 Kgs / 0.82 CUFT

SS-422S 22pcs 1/2" Dr. SAE Hand Socket Set

- 22 6pt. Socket
5/16 - 3/8 - 7/16 - 1/2 - 9/16 - 19/32 -
5/8 - 11/16 - 3/4 - 25/32 - 13/16 - 7/8 -
15/16 - 1" - 1 1/16 - 1 1/8 - 1 3/16 -
1 1/4 - 1 5/16 - 1 3/8 - 1 7/16 - 1 1/2"



6 pt.

1/3 Tray
4000g 3 Sets / 13 Kgs / 0.82 CUFT

deep DS-422S 22pcs 1/2" Dr. SAE Deep Hand Socket Set

- 22 6pt. Deep Socket
5/16 - 3/8 - 7/16 - 1/2 - 9/16 - 19/32 -
5/8 - 11/16 - 3/4 - 25/32 - 13/16 - 7/8 -
15/16 - 1" - 1 1/16 - 1 1/8 - 1 3/16 -
1 1/4 - 1 5/16 - 1 3/8 - 1 7/16 - 1 1/2"



6 pt.

1/3 Tray
6700g 3 Sets / 21 Kgs / 0.82 CUFT

1/3 Tray Sets

TW-423M 23pcs 1/2" Dr. Metric Hand Socket Set

- 18 12pt. Socket 8 - 10 - 11 - 12 - 13 -
14 - 15 - 16 - 17 - 18 - 19 - 21 -
22 - 23 - 24 - 27 - 30 - 32mm
- 1 Universal Joint 1 Sliding T-Handle
- 2 Ext. 125 - 250mL
- 1 Quick Release Ratchet



12 pt.

1/3 Tray
4180g 5 Sets / 22 Kgs / 0.93 CUFT

TW-423S 23pcs 1/2" Dr. SAE Hand Socket Set

- 18 12pt. Socket 5/16 - 3/8 - 7/16 - 1/2 -
9/16 - 19/32 - 5/8 - 11/16 - 3/4 -
25/32 - 13/16 - 7/8 - 15/16 - 1" -
1 1/16 - 1 1/8 - 1 3/16 - 1 1/4"
- 1 Universal Joint 1 Sliding T-Handle
- 2 Ext. 5 - 10"L
- 1 Quick Release Ratchet



12 pt.

1/3 Tray
4400g 5 Sets / 23 Kgs / 0.93 CUFT

TX-2353 53pcs 1/4" & 3/8" Dr. Complete Bit Socket Set

- 5 1/4" & 3/8" Dr. Slotted 3 - 4 - 5 - 6 - 8mm (45 & 50mmL)
- 4 1/4" & 3/8" Dr. Phillips #1 - 2 - 3 - 4 (45 & 50mmL)
- 10 1/4" & 3/8" Dr. Metric Hex 2 - 2.5 - 3 - 4 - 5 - 6 - 7 - 8 - 10 - 12 (45 & 50mmL)
- 14 1/4" & 3/8" Dr. SAE Hex
1/16 - 5/64 - 3/32 - 7/64 - 1/8 -
5/32 - 3/16 - 7/32 - 1/4 - 9/32 -
5/16 - 3/8 - 7/16 - 1/2" (45 & 50mmL)
- 14 1/4" & 3/8" Dr. Star
T6 - 7 - 8 - 9 - 10 - 15 - 20 - 25 - 27 -
30 - 40 - 45 - 50 - 55 (45 & 50mmL)
- 6 3/8" Dr. Triple Square M4 - 5 - 6 - 8 - 10 - 12 (50mmL)



1/3 Tray
2500g 5 Sets / 13.5 Kgs / 0.93 CUFT

BS-3424P 24pcs 3/8" & 1/2" Dr. Slotted & Phillips Bit Socket Set

- 10 3/8" Dr. Slotted
4 - 5 - 6 - 8 - 9mm (50 & 140mmL)
- 6 1/2" Dr. Slotted
12 - 14 - 16mm (80 & 150mmL)
- 4 3/8" Dr. Phillips #1 - 2 (50 & 140mmL)
- 4 1/2" Dr. Phillips #3 - 4 (80 & 150mmL)



1/3 Tray
4180g 5 Sets / 17.5 Kgs / 0.93 CUFT

BS-3424H 24pcs 3/8" & 1/2" Dr. SAE Hex Bit Socket Set

- 14 3/8" Dr. SAE Hex 1/8 - 5/32 - 3/16 -
7/32 - 1/4 - 9/32 - 5/16"
(50 & 140mmL)
- 10 1/2" Dr. SAE Hex 3/8 - 7/16 - 1/2 -
9/16 - 5/8" (80 & 150mmL)



1/3 Tray
3240g 5 Sets / 17.5 Kgs / 0.93 CUFT

BS-3424T 24pcs 3/8" & 1/2" Dr. Star Bit Socket Set

- 14 3/8" Dr. Star T10 - 15 - 20 - 25 - 27 -
30 - 40 (50 & 140mmL)
- 10 1/2" Dr. Star T45 - 50 - 55 - 60 - 70
(80 & 150mmL)



1/3 Tray
2660g 5 Sets / 14.5 Kgs / 0.93 CUFT

BS-3424TA 24pcs 3/8" & 1/2" Dr. Tamperproof Star Bit Socket Set

- 14 3/8" Dr. Tamperproof Star
T10 - 15 - 20 - 25 - 27 - 30 - 40
(50 & 140mmL)
- 10 1/2" Dr. Star Tamperproof
T45 - 50 - 55 - 60 - 70
(80 & 150mmL)



1/3 Tray
2660g 5 Sets / 14.5 Kgs / 0.93 CUFT

1/3 Tray Sets

TR-507S 7pcs Slotted & Philips Screwdriver Set

4 Slotted:
3.0x155 - 4.0x180 -
6.0x250 - 6.5x250mmL

3 Philips: #0x75 -
#1x200 - #2x225mmL



920g 5 Sets / 6 Kgs / 0.93 CUFT

TR-508Z 8pcs Combination Screwdriver Set

4 Slotted: 5.5x200 -
6.5x250 - 8.0x280 -
10.0x320mmL

2 Philips:
#1x200 - #2x225mmL

2 Posidriv:
#1x180 - #2x250mmL



1340g 10 Sets / 14.5 Kgs / 1.58 CUFT

TR-510TA 10pcs Tamperproof Star Screwdriver Set

10 Tamperproof Star:
T8x150 - T10x180 -
T15x180 - T20x200 -
T25x200 - T27x225 -
T30x225 - T40x255 -
T45x255 - T50x235mmL



1480g 10 Sets / 16 Kgs / 1.58 CUFT

HR-5608M 8pcs Metric Hex Screwdriver Set

8 Metric Hex:
2x150 - 2.5x150 -
3x150 - 4x170 -
5x185 - 6x185 -
7x235 - 8x235mmL



1140g 10 Sets / 14 Kgs / 1.58 CUFT

HR-5611S 11pcs SAE Hex Screwdriver Set

11 SAE Hex: 1/16"x150 -
5/64"x150 - 3/32"x150 -
7/64"x150 - 1/8"x150 -
5/32"x170 - 3/16"x185 -
7/32"x185 - 1/4"x225 -
9/32"x235 - 5/16"x235mmL

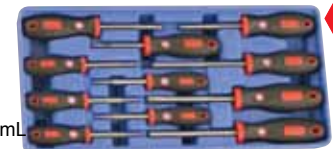

1390g 10 Sets / 16 Kgs / 1.58 CUFT

HR-578MW 8pcs Metric Wobble Hex Screwdriver Set

8 Metric Wobble Hex:
3x150 - 4x170 - 5x185 -
6x185 - 7x235 - 8x235 -
9x235 - 10x235mmL



1390g 10 Sets / 16.5 Kgs / 1.58 CUFT

HR-578SW 8pcs SAE Wobble Hex Screwdriver Set

11 SAE Wobble Hex:
1/8"x150 - 5/32"x170 -
3/16"x185 - 7/32"x185 -
1/4"x225 - 9/32"x235 -
5/16"x235 - 3/8"x235mmL



1340g 10 Sets / 15.5 Kgs / 1.58 CUFT

1/3 Tray Sets

TL-508 8pcs Slotted & Philips Screwdriver Set

4 Slotted: 6.5x86 -
6.5x210 - 8.0x295 -
10.0x320mmL

4 Philips: #1x86 -
#1x185 - #2x235 -
#2x310mmL



1350g 10 Sets / 14 Kgs / 1.58 CUFT

TX-512A 12pcs Tamperproof Star Screwdriver Set

12 Tamperproof Star:
T6x145 - T7x145 -
T8x145 - T9x145 -
T10x175 - T15x175 -
T20x195 - T25x195 -
T27x215 - T30x215 -
T40x250 - T45x250mmL



1400g 10 Sets / 15 Kgs / 1.58 CUFT

HS-5610M 10pcs Metric Hex Screwdriver Set

10 Metric Hex:
2x145 - 2.5x145 -
3x145 - 4x145 -
5x180 - 6x180 -
7x225 - 8x225 -
9x225 - 10x225mmL



1470g 5 Sets / 8.5 Kgs / 0.93 CUFT

HS-5612S 12pcs SAE Hex Screwdriver Set

12 SAE Hex: 1/16"x145 -
5/64"x145 - 3/32"x145 -
7/64"x145 - 1/8"x145 -
5/32"x145 - 3/16"x180 -
7/32"x180 - 1/4"x225 -
9/32"x225 - 5/16"x225
3/8"x225mmL

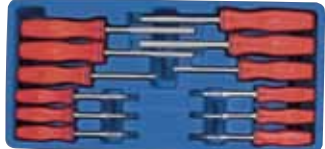

1500g 5 Sets / 8.5 Kgs / 0.93 CUFT

HS-5708MW 8pcs Metric Wobble Hex Screwdriver Set

8 Metric Wobble Hex:
3x145 - 4x145 - 5x180 -
6x180 - 7x225 - 8x225 -
9x225 - 10x225mmL



1370g 5 Sets / 7.5 Kgs / 0.93 CUFT

HS-5708SW 8pcs SAE Wobble Hex Screwdriver Set

8 SAE Wobble Hex:
1/8"x145 - 5/32"x145 -
3/16"x180 - 7/32"x180 -
1/4"x225 - 9/32"x225 -
5/16"x225 -
3/8"x225mmL



1290g 5 Sets / 7.5 Kgs / 0.93 CUFT

SB-247M 47pcs Screwdriver Bit Set

4 Posidriv (30 & 88mmL)
#1 - 2

12 Hex (30 & 88mmL)
4 - 5 - 6 - 7 - 8 - 10mm

20 Tamperproof Star
(30 & 88mmL)
T10 - 15 - 20 - 25 - 27 - 30 - 40 - 45 - 50 - 55

8 Triple Square: M5 - 6 - 8 - 10 (30 & 88mmL)

3 Bit Holder 3/8" Dr. x 1/4" - 5/16" - 10mm Hex Shank



1470g 10 Sets / 16 Kgs / 1.58 CUFT

1/3 Tray Sets

CW-007M 7pcs Metric Combination Wrench Set

7 Metric Combination:
(748210 ~ 748224)
10 - 12 - 14 - 17 -
19 - 22 - 24mm



1/3 Tray 1850g 10 Sets / 19.5 Kgs / 1.58 CUFT

PR-015M 15pcs Metric Combination Wrench Set

15 Metric Combination:
(748207 ~ 748224)
7 - 8 - 9 - 10 - 11 - 12 -
13 - 14 - 15 - 16 - 17 -
18 - 19 - 22 - 24mm



1/3 Tray 2500g 10 Sets / 26.5 Kgs / 1.58 CUFT

GW-7607M 7pcs Metric Combination Ratcheting Wrench Set

7 Metric Combination:
(768508 ~ 768519)
8 - 10 - 12 - 13 -
14 - 17 - 19mm



1/3 Tray 1260g 10 Sets / 13.5 Kgs / 1.58 CUFT

DE-707M 7pcs Metric Offset Box End Wrench Set

7 Metric Box End:
(740607 ~ 741819)
6x7 - 8x9 - 10x11 -
12x13 - 14x15 -
16x17 - 18x19mm



1/3 Tray 1340g 10 Sets / 14.5 Kgs / 1.58 CUFT

CP-5704 4pcs Pliers Set

1 8" Side Cutter Pliers (550812)
1 7" Diagonal Cutting Pliers (550707)
1 8" Chain Nose Pliers w/ Cutter (550804)
1 8" Combination Slip Joint Pliers (550809)



1/3 Tray 1630g 10 Sets / 17.5 Kgs / 0.93 CUFT

CP-5804 4pcs General Purpose Pliers Set

1 6" Chain Nose Pliers w/ Cutter (550604D)
1 6" Diagonal Cutting Pliers (550607D)
1 7" Side Cutter Pliers (550712D)
1 10" Water Pump Pliers (551011D)



1/3 Tray 1590g 10 Sets / 17 Kgs / 0.93 CUFT

CW-408MS 8pcs 1/2" Dr. Metric & SAE Metric COLOUR MATCH®

4 1/2" Dr. 6pt. Thin Wall Socket w/ Plastic Sleeve

- 448517W 17mm
- 448519W 19mm
- 448521W 21mm
- 468526W 13/16"

4 1/2" Torque Extension Bar

- 487080 80 ft.lb. (110Nm)
- 487090 90 ft.lb. (120Nm)
- 487100 100 ft.lb. (135Nm)
- 487110 110 ft.lb. (150Nm)

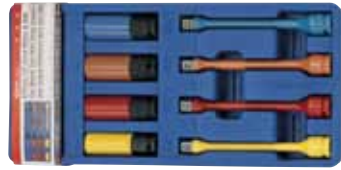

1/3 Tray 2170g 5 Sets / 12 Kgs / 0.93 CUFT

1/2 Tray Sets

MS-042M 42pcs 3/8" Dr. Metric Impact Socket & Star Socket Set

7 3/8"Dr. E-Star Hand Socket
E10 - 11 - 12 - 14 - 16 - 18 - 20

16 3/8"Dr. Deep Impact Socket 7 - 8 - 9 - 10 - 11 - 12 -
13 - 14 - 15 - 16 - 17 - 18 - 19 - 20 - 21 - 22mm

12 3/8"Dr. Swivel Impact Socket 8 - 9 - 10 - 11 - 12 -
13 - 14 - 15 - 16 - 17 - 18 - 19mm

3 3/8"Dr. Impact Ext. 75 - 125 - 200mmL

1 3/8"Dr. Impact Uni. Joint 1 3/8"Dr. L-Handle

2 3/8"Dr. Flex Head Ratchet & Stubby Ratchet



1/2 Tray 5080g 3 Sets / 16.5 Kgs / 1.35 CUFT

MS-065S 65pcs 3/8" Dr. Head Driver & Impact Socket Set

13 3/8"Dr. Impact Socket 5/16 - 11/32 - 3/8 - 7/16 - 1/2 -
9/16 - 19/32 - 5/8 - 11/16 - 3/4 - 25/32 - 13/16 - 7/8"

8 3/8"Dr. Swivel Impact Socket
5/16 - 3/8 - 7/16 - 1/2 - 9/16 - 5/8 - 11/16 - 3/4"

10 3/8"Dr. Hex Head 5/32 - 3/16 - 7/32 - 1/4 -
5/16 - 3/8 - 7/16 - 1/2 - 9/16 - 5/8"

11 3/8"Dr. Hex Head
4 - 5 - 6 - 7 - 8 - 9 - 10 - 12 - 14 - 16 - 17mm

10 3/8"Dr. Star Head
T10 - 15 - 20 - 25 - 27 - 30 - 40 - 45 - 50 - 55

3 3/8"Dr. Slotted Head 5.5 - 8 - 10mm

4 3/8"Dr. Phillips Head #1 - 2 - 3 - 4

5 3/8"Dr. Triple Square Head M5 - 6 - 8 - 10 - 12

1 3/8"Dr. Impact Driver



1/2 Tray 4920g 3 Sets / 16 Kgs / 1.35 CUFT

MS-027S 27pcs 1/2" Dr. SAE Impact Socket & Accessory Set

10 1/2"Dr. Deep Impact Socket 15/16 - 1" - 1 1/16 -
1 1/8 - 1 3/16 - 1 1/4 - 1 5/16 - 1 3/8 - 1 7/16 - 1 1/2"

8 1/2"Dr. Swivel Impact Socket
7/16 - 1/2 - 9/16 - 5/8 - 11/16 - 3/4 - 13/16 - 7/8"

4 1/2"Dr. Hex Bit Socket
9/16 - 5/8 - 11/16 - 3/4" (80mmL)

3 1/2"Dr. Impact Ext. 75 - 125 - 250mmL

1 1/2"Dr. Impact Universal Joint

1 1/2"Dr. L-Handle



1/2 Tray 8660g 3 Sets / 27 Kgs / 1.35 CUFT

MS-435I 35pcs 1/2" Dr. Metric Deep Impact Socket Set (Cr-V)

15 1/2"Dr. Impact Socket
10 - 12 - 13 - 14 - 15 - 16 - 17 - 18 - 19 - 21 -
22 - 24 - 27 - 30 - 32mm

15 1/2"Dr. Deep Impact Socket
10 - 12 - 13 - 14 - 15 - 16 - 17 - 18 - 19 - 21 -
22 - 24 - 27 - 30 - 32mm

4 1/2"Dr. Impact Extension Bars
50 - 75 - 125 - 250mmL

1 1/2"Dr. Impact Universal Joint



1/2 Tray 7100g 3 Sets / 23 Kgs / 1.35 CUFT

1/2 Tray Sets

MS-121M 121pcs 1/4" Dr. Metric Hand Socket & Bit Set

- 12 1/4"Dr. Socket 4 ~ 13mm
- 8 1/4"Dr. Deep Hand Socket 5 ~ 13mm
- 14 1/4"Dr. Head Socket
Hex 3 ~ 10mm - Slotted 4.0 ~ 6.5 - Philips #1 ~ 3
- 6 1/4"Dr. E-Star Socket E4 ~ 10
- 9 1/4"Dr. Star Bit Socket T8 - 40
- 44 Slotted Bit 3.0 ~ 7.0mm - Philip Bit #0 ~ 3 -
Hex Bit 2 ~ 8mm - Star Bit T6 ~ 40 -
Tamperproof Star T7 ~ 45 - Triple Square M4 ~ 6
- 9 Wobble Hex Key 1.5 ~ 10mm
- 10 Tamperproof Star Key T9 ~ 50
- 3 1/4"Dr. Bit Holder - Adapter - Universal Joint
- 4 1/4"Dr. Ext. 50 - 100mmL & Wobble Ext. 225mmL & Flex. Ext. 150mmL
- 2 1/4"Dr. Socket Driver & Quick Release Ratchet



1/2 Tray 2900g 3 Sets / 10.5 Kgs / 1.35 CUFT

MS-071M 71pcs 3/8" Dr. Metric Hand Socket & Bit Socket Set

- 24 3/8"Dr. Shallow & Deep Hand Socket 8 - 9 - 10 -
11 - 12 - 13 - 14 - 15 - 16 - 17 - 18 - 19mm
- 6 3/8"Dr. E-Star Socket E10 - 11 - 12 - 14 - 16 - 18
- 31 3/8"Dr. Bit Socket Slotted 4.0 ~ 6.0mm -
Philips #1 ~ 3 - Hex 3 ~ 12mm -
Star T10 ~ 55 - Triple Square M5 ~ 12
- 2 3/8"Dr. Adapter - Universal Joint
- 2 3/8"Dr. Spark Plug 16mm - 20.6mm
- 4 3/8"Dr. Extension Bar 75 - 150 - 200mmL -
3/8"Dr. Wobble Extension Bar 45mmL
- 1 1/4" & 3/8" Double Drive Ratchet
- 1 3/8"Dr. Quick Release Ratchet



1/2 Tray 4700g 3 Sets / 16 Kgs / 1.35 CUFT

MS-435M 35pcs 1/2" Dr. Metric Deep Hand Socket Set

- 15 1/2"Dr. 12pt. Hand Socket
10 - 12 - 13 - 14 - 15 - 16 - 17 - 18 - 19 - 21 -
22 - 24 - 27 - 30 - 32mm
- 15 1/2"Dr. 6pt. Deep Hand Socket
10 - 12 - 13 - 14 - 15 - 16 - 17 - 18 - 19 - 21 -
22 - 24 - 27 - 30 - 32mm
- 4 1/2"Dr. Wobble Extension Bars
50 - 75 - 125 - 250mmL
- 1 1/2"Dr. Universal Joint



1/2 Tray 5900g 3 Sets / 19.5 Kgs / 1.35 CUFT

MS-437M 37pcs 1/2" Dr. Metric Hand Socket Set

- 19 1/2"Dr. Hand Socket
8 - 9 - 10 - 11 - 12 - 13 - 14 - 15 - 16 - 17 - 18 -
19 - 21 - 22 - 24 - 27 - 30 - 32 - 36mm
- 9 1/2"Dr. E-Star Hand Socket
E10 - 11 - 12 - 14 - 16 - 18 - 20 - 22 - 24
- 2 1/2"Dr. Adapter - Universal Joint
- 2 1/2"Dr. Spark Plug 16mm - 20.6mm
- 3 1/2"Dr. Ext. 50 - 125 - 250mmL
- 1 1/2"Dr. Hinge Handle 410mmL
- 1 1/2"Dr. Quick Release Ratchet



1/2 Tray 5700g 3 Sets / 19 Kgs / 1.35 CUFT

1/2 Tray Sets

MS-442B 42pcs 1/2" Dr. Complete Bit Socket Set

- 16 1/2"Dr. Hex Bit Socket
5 - 6 - 7 - 8 - 9 - 10 - 12mm (55mmL)
14 - 17 - 19mm (80mmL)
5 - 6 - 7 - 8 - 10 - 12mm (110mmL)
- 14 1/2"Dr. Star Bit Socket
T30 - 40 - 45 - 50 - 55 (55mmL)
T60 - 70 (60mmL)
T30 - 40 - 45 - 50 - 55 - 60 - 70 (110mmL)
- 12 1/2"Dr. Triple Square Bit Socket
M6 - 8 - 10 - 12 - 14 (55mmL) - 16 - 18 (60mmL)
M8 - 10 - 12 - 14 - 16 (110mmL)



1/2 Tray 5100g 3 Sets / 17 Kgs / 1.35 CUFT

MS-057M 57pcs 1/4" & 1/2" Dr. Swivel Socket & Bit Socket Set

- 16 1/4"Dr. Star Hand Socket E4 - 5 - 6 - 7 - 8 - 10 - 11
1/2"Dr. Star Hand Socket E10 - 11 - 12 - 14 - 16 -
18 - 20 - 22 - 24
- 9 1/4"Dr. Universal Hand Socket 6 - 7 - 8 - 9 - 10 -
11 - 12 - 13 - 14mm
- 11 1/2"Dr. Swivel Impact Socket 11 - 12 - 13 - 14 -
15 - 16 - 17 - 18 - 19 - 21 - 22mm
- 10 1/2"Dr. Tamperproof Star Bit Socket T20 - 25 -
27 - 30 - 40 - 45 - 50 - 55 - 60 - 70 (80mmL)
- 9 1/2"Dr. Triple Square Bit Socket
M4 - 5 - 6 - 8 - 10 - 12 - 14 - 16 - 18 (80mmL)
- 2 1/4" Dr. & 1/2"Dr. Rotor Ratchet

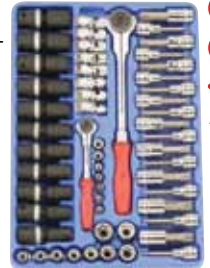

1/2 Tray 6820g 3 Sets / 21.5 Kgs / 1.35 CUFT

MS-020M 20pcs Metric Combination Wrench Set

- 20 Combination Wrench (748206 ~ 748232)
6 - 7 - 8 - 9 - 10 - 11 - 12 - 13 -
14 - 15 - 16 - 17 - 18 - 19 - 21 -
22 - 24 - 27 - 30 - 32mm



1/2 Tray 4800g 3 Sets / 16.5 Kgs / 1.35 CUFT

MS-020B 20pcs Metric Box End, Open End & E-Star Wrench Set

- 8 Box End Wrench (740607 ~ 742022)
6x7 - 8x9 - 10x11 - 12x13 - 14x15 - 16x17 -
18x19 - 20x22mm
- 8 Open End Wrench (790607 ~ 792022)
6x7 - 8x9 - 10x11 - 12x13 - 14x15 - 16x17 -
18x19 - 20x22mm
- 4 E-Star Wrench (790608 ~ 792024)
E6x8 - 10x12 - 14x18 - 20x24



1/2 Tray 2700g 3 Sets / 9 Kgs / 1.35 CUFT

MS-024M 24pcs Metric Combination & Box End Wrench Set

- 16 Combination Wrench (748206 ~ 748222)
6 - 7 - 8 - 9 - 10 - 11 - 12 - 13 - 14 - 15 - 16 -
17 - 18 - 19 - 21 - 22mm
- 8 Box End Wrench (740607 ~ 742022)
6x7 - 8x9 - 10x11 - 12x13 - 14x15 - 16x17 -
18x19 - 20x22mm



1/2 Tray 3600g 3 Sets / 12.5 Kgs / 1.35 CUFT

1/2 Tray Sets

MS-035M 35pcs Metric Flare Nut & L-Shaped Key Wrench Set

- 6 Flare Nut Wrench (740911 ~ 741921)
9x11 - 10x12 - 13x14 - 15x17 - 16x18 - 19x21mm
- 12 Long Hex Key Wrench 6 - 7 - 8 - 9 - 10 - 11 - 12 - 13 - 14 - 16 - 17 - 19mm
- 7 Triple Square Key Wrench
M5 - 6 - 8 - 10 - 12 - 14 - 16
- 6 Screw Extractor
#1 - 2 - 3 - 4 - 5 - 6
- 4 1/2" Dr. Stud Remover Socket
6 - 8 - 10 - 12mm



1/2 Tray
7040g 3 Sets / 22.5 Kgs / 1.35 CUFT

MS-028S 28pcs SAE Flare Nut, E-Star & L-Shaped Key Wrench

- 5 Flare Nut Wrench (760810 ~ 762428) 1/4x5/16 - 3/8x7/16 - 1/2x9/16 - 5/8x11/16 - 3/4x7/8"
- 4 E-Star Wrench (790608 ~ 792024)
E6x8 - 10x12 - 14x18 - 20x24mm
- 8 Long Hex Key Wrench
1/4 - 5/16 - 3/8 - 7/16 - 1/2 - 9/16 - 5/8 - 3/4"
- 5 Offset Screwdriver
Slotted 6.0 - 8.0 - 9.0mm & Philips #1x2 - 3x4
- 4 1/2" Dr. Stud Remover Socket
1/4 - 5/16 - 3/8 - 7/16"
- 2 Pick-up Tool (330~685mmL) & Hinged Mirror (50x90mm)



1/2 Tray
5520g 3 Sets / 18 Kgs / 1.35 CUFT

MS-013SP 13pcs Slotted & Philips Screwdriver Set

- 7 Slotted Screwdriver
3.0x155 - 4.0x180 - 5.0x330 - 6.0x250 - 6.5x250 - 8.0x300 - 6.9x98mmL
- 5 Philips Screwdriver
#0x155 - 1x170 - 2x200 - 3x270 - 2x98mmL
- 1 Pry Bar
300mmL (12"L)



1/2 Tray
1500g 3 Sets / 6.3 Kgs / 1.35 CUFT

MS-014 14pcs Slotted, Philips & Posidriv Screwdriver Set

- 4 Slotted Screwdriver
10x370 - 12x320 - 14x370 - 6.5x98mmL
- 6 Philips Screwdriver
#2x300 - 3x245 - 3x390 - 4x320 - 1x98 - 2x98mmL
- 4 Posidriv Screwdriver
#3x295 - 4x340 - 1x98 - 2x98mmL



1/2 Tray
2720g 3 Sets / 9.5 Kgs / 1.35 CUFT

MS-013T 13pcs Star Screwdriver Set

- 13 Star Screwdriver
T6x150 - T7x150 - T8x150 - T9x150 - T10x185 - T15x185 - T20x185 - T25x185 - T27x225 - T30x225 - T40x235 - T45x235 - T50x235mmL



1/2 Tray
1500g 3 Sets / 6.3 Kgs / 1.35 CUFT

1/2 Tray Sets

MS-025R 25pcs Hex Screwdriver & Ratcheting Screwdriver Set

- 8 Hex Screwdriver
2x150 - 2.5x150 - 3x150 - 4x170 - 5x185 - 6x185 - 7x235 - 8x235mmL
- 11 1/4" Hex Shank Nut Driver
4 - 5 - 5.5 - 6 - 7 - 8 - 9 - 10 - 11 - 12 - 13mm
- 4 Flexible Bit Holder - Magnetic Bit Holder Adapter - Socket Holder Adapter - Spinner Handle
- 1 1/4" Hex Shank Standard Ratcheting Screwdriver
- 1 1/4" Hex Shank T-Handle Ratcheting Screwdriver



1/2 Tray
2000g 3 Sets / 7.8 Kgs / 1.35 CUFT

MS-013 13pcs Tang-Thru Screwdriver, Pry Bar & Carbon Scraper

- 2 Slotted Tang-Thru Screwdriver
6.5x245 - 14x365mmL
- 2 Philips Tang-Thru Screwdriver
#1x220 - 4x305mmL
- 4 Posidriv Tang-Thru Screwdriver
#1x200 - 2x245 - 3x270 - 4x320mmL
- 3 Rigid Carbon Scraper
12x250 - 26x200 - 26x300mmL
- 2 Pry Bar
200mmL (8"L) - 300mmL (12"L)



1/2 Tray
2920g 3 Sets / 10 Kgs / 1.35 CUFT

MS-048MS 48pcs Hex, Star, Triple Square & Square Bit Set

- 13 Hex Bit 3 - 4 - 5 - 6 - 7 - 8mm (160mmL)
1/8 - 5/32 - 3/16 - 7/32 - 1/4 - 9/32 - 5/16" (160mmL)
- 13 Wobble Hex Bit 3 - 4 - 5 - 6 - 7 - 8mm (160mmL)
1/8 - 5/32 - 3/16 - 7/32 - 1/4 - 9/32 - 5/16" (160mmL)
- 12 Tamperproof Star Bit T7 - 8 - 9 - 10 - 15 - 20 - 25 - 27 - 30 - 40 - 45 - 50 (160mmL)
- 4 Triple Square Bit M4 - 5 - 6 - 8 (160mmL)
- 5 Square Bit #0 - 1 - 2 - 3 - 4 (160mmL)
- 1 1/4" & 5/16" Hex Shank OMNIDRIVE 3in1 Handgrip

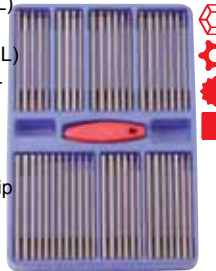

1/2 Tray
2640g 3 Sets / 9 Kgs / 1.35 CUFT

MS-007P 7pcs Pliers Set

- 1 Water Pump Pliers 250mmL (10"L)
- 1 Bent Nose Pliers 200mmL (8"L)
- 1 Chain Nose Pliers with Cutter 200mmL (8"L)
- 1 Side Cutter Pliers 180mmL (7"L)
- 1 Heavy Duty Diagonal Cutting Pliers 180mmL (7"L)
- 1 Curved Jaw Locking Pliers with Cutter 250mmL (10"L)
- 1 Long Nose Locking Pliers with Cutter 150mmL (6"L)



1/2 Tray
2500g 3 Sets / 9.3 Kgs / 1.35 CUFT

MS-019 19pcs Punch, Chisel & Hammer Set

- 5 Flat Chisel
6 - 10 - 14 - 19 - 25mm
- 6 Pin Punch
2 - 3 - 4 - 5 - 6 - 8mm
- 1 Center Punch
4mm
- 5 Taper Bit Extractor
3 - 5 - 6 - 8 - 9mm
- 1 Ball Peen Hammer 1 lbs. (454 g)
- 1 Drilling Hammer 2 1/2 lbs. (1135 g)



1/2 Tray
3900g 3 Sets / 13.5 Kgs / 1.35 CUFT

1/2 Tray Sets

MS-008R 8pcs Retaining Ring Pliers & Oil Filter Wrench Set

- 1 Straight Nose, External Retaining Ring Pliers
- 1 Straight Nose, Internal Retaining Ring Pliers
- 1 90° Bent Nose, External Retaining Ring Pliers
- 1 90° Bent Nose, Internal Retaining Ring Pliers
- 3 Oil Filter Wrench
60~73mm (2-3/8 ~ 2-7/8") -
73~85mm (2-7/8 ~ 3-3/8") -
85~95mm (3-3/8 ~ 3-3/4")
- 1 Oil Filter Pliers 50 ~ 115mm (2" ~ 4-1/2")

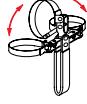

1/2 Tray 2100g 3 Sets / 8.1 Kgs / 1.35 CUFT

MS-014A 14pcs Combination Auto Repair Tool Kit

- 4 Miniature Pick
Awl - Hook - Bent Tip 45° - Bent Tip 90°
- 2 O-Ring Oil Seal Pick
Hook & O-Ring 90° Tip (double end)
Bent Tip 90° & Bent Tip 45° (double end)
- 2 Carbon Scraper
12mm x 250mmL & 26mm x 300mmL
- 1 Trim Pad Remover 230mmL (9.1"L)
- 1 Brake Spring Pliers 330mmL (13"L)
- 1 Magnetic Pick-up Tool 135 ~ 645mmL
- 1 Hinged Mirror 57mm Diameter
- 2 Heater Hose Clamp Pliers

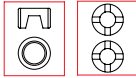

1/2 Tray 1800g 3 Sets / 7.2 Kgs / 1.35 CUFT

2/3 Tray Sets

TL-518 18pcs Slotted & Philips Screwdriver Set

- 5 Slotted: 5.0x345 -
6.5x195 - 10.0x310 -
10.0x360 - 6.5x86mmL
- 7 Philips: #1x170 - #1x345 -
#2x140 - #2x295 - #2x395 -
#3x310 - #1x86mmL
- 3 Micro-Tech Slotted:
2.0 - 2.5 - 3.0mm
- 3 Micro-Tech Philips:
#000 - #00 - #0



2/3 Tray 2360g 5 Sets / 13 Kgs / 1.58 CUFT

CP-5312 12pcs Locking Pliers Set

- 3 Curved Jaw Locking Pliers w/ Cutters:
5" - 7" - 10"
- 2 Long Nose Locking Pliers w/ Cutter:
6" - 9"
- 2 Straight Jaw Locking Pliers: 7" - 10"
- 2 Locking "C" Clamps: 6" - 11"
- 1 Water Pump Pliers: 10"
- 1 Chain Nose Pliers w/ Cutter: 8"
- 1 Heavy Duty Diagonal Cutting Pliers: 8"



2/3 Tray 5400g 5 Sets / 28 Kgs / 1.58 CUFT

Full Tray Sets

MS-106M 106pcs 3/8" Dr. Metric Tool Set

- 17 3/8"Dr. 6pt. Hand Socket 6 ~ 22mm
- 17 3/8"Dr. Deep Hand Socket
6 ~ 22mm
- 10 3/8"Dr. 12pt. Universal Socket
10 ~ 19mm
- 16 3/8"Dr. Impact Socket 7 ~ 22mm
- 5 3/8"Dr. Slotted Bit Socket
4 ~ 9mm(50mmL)
- 4 3/8"Dr. Philips Bit Socket
#1 ~ 4(50mmL)
- 20 3/8"Dr. Hex Bit Socket 3 ~ 12mm(50 & 140mmL)
- 1 3/8"Dr. Universal Joint
- 10 3/8"Dr. Star Bit Socket T10 ~ 55mm(50mmL)
- 1 3/8"Dr. Sliding T-Handle
- 2 3/8"Dr. Adapter 1/4"M & 1/2"M
- 2 3/8"Dr. Ext 45 & 150mmL
- 1 3/8"Dr. Quick Release Ratchet



Full Tray 7600g 2 Sets / 17 Kgs / 1.76 CUFT

MS-090S 90pcs 3/8" Dr. SAE Tool Set

- 14 3/8"Dr. 6pt. Hand Socket 1/4 ~ 7/8"
- 14 3/8"Dr. Deep Hand Socket
14 ~ 7/8"
- 7 3/8"Dr. 12pt. Universal Socket
3/8 ~ 3/4"
- 13 3/8"Dr. Dep Impact Socket
5/16 ~ 7/8"
- 20 3/8"Dr. Hex Bit Socket
1/8 ~ 1/2"(50 & 140mmL)
- 10 3/8"Dr. Star Bit Socket T10 ~ 55mm(140mmL)
- 2 3/8"Dr. Ext. 3 - 7 7/8"L
- 7 3/8"Dr. Triple Square M4 ~ 14(50mmL)
- 1 3/8"Dr. Hinge Handle
- 1 3/8"Dr. 72 Teeth Rotor Ratchet
- 1 3/8"Dr. 72 Teeth Reversible Ratchet



Full Tray 8300g 2 Sets / 19 Kgs / 1.76 CUFT

MS-098M 98pcs 1/4" & 1/2" Dr. Metric Tool Set

- 11 1/4"Dr. Hand Socket 5 ~ 14mm
- 12 1/4"Dr. Deep Hand Socket
4 ~ 14mm
- 18 1/2"Dr. 12pt. Hand Socket
8 ~ 32mm
- 14 1/2"Dr. Impact Socket 10 ~ 24mm
- 3 1/2"Dr. Deep Impact Socket
17 ~ 21mm
- 5 Ext. 1/4"Dr. 50 - 100 - 150mmL
1/2"Dr. 125 - 250mmL
- 7 Hex Bit Socket 1/4"Dr. 3 ~ 5mm(45mmL) & 1/2"Dr. 6 ~ 12mm(80mmL)
- 7 Star Bit Socket 1/4"Dr. T20 ~ 30mm(45mmL) & 1/2"Dr. T40 ~ 55mm(80mmL)
- 2 1/4" & 1/2"Dr. Universal Joint
- 2 1/4" & 1/2"Dr. Sliding T-Handle
- 2 1/4" & 1/2"Dr. Quick Release Ratchet
- 1 1/4" Socket Driver
- 7 Box End Wrench 6x7 ~ 18x19mm
- 7 Open End Wrench 6x7 ~ 18x19mm



Full Tray 9800g 2 Sets / 22 Kgs / 1.76 CUFT

MS-100S 100pcs 1/4" & 1/2" Dr. SAE Tool Set

- 10 1/4"Dr. Hand Socket 3/16 ~ 9/16"
- 10 1/4"Dr. Deep Hand Socket
3/16 ~ 9/16"
- 6 1/4"Dr. 12pt. Universal Socket
1/4 ~ 9/16"
- 18 1/2"Dr. 12pt. Hand Socket
5/16 ~ 1 1/4"
- 9 1/2"Dr. Deep Hand Socket 1/2 ~ 1"
- 13 1/2"Dr. Impact Socket 3/8 ~ 1"
- 3 1/2"Dr. Deep Impact Skt 3/4 ~ 7/8"
- 9 Hex Bit Socket 1/4"Dr. 1/8 ~ 7/32(45mmL) & 1/2"Dr. 1/4 ~ 1/2"(80mmL)
- 2 1/2"Dr. Spark Plug 5/8" - 13/16"
- 9 Wobble Hex Key 1/16" - 3/8"
- 6 Box End Wrench 1/4x5/16 ~ 7/8x15/16"
- 5 Open End Wrench 1/4x5/16 ~ 3/4x7/8"



Full Tray 10.3 Kg 2 Sets / 23 Kgs / 1.76 CUFT

Full Tray Sets

MS-086 86pcs Screwdriver & Bit Set

- 4 Slotted Screwdriver 5.5 ~ 10mm
- 2 Philips Screwdriver #1 ~ 2
- 2 Posidriv Screwdriver #1 ~ 2
- 10 Tamperproof Star Screwdriver T8 ~ 50
- 6 Slotted Bit 3 ~ 7mm
- 4 Philips Bit #0 ~ 3
- 19 Hex Bit 2 ~ 8mm & 1/16 ~ 5/16"
- 11 Star Bit T6 ~ 40
- 3 Triple Square Bit M4 ~ 6
- 9 Wobble Hex Key 1.5 ~ 10mm
- 10 Tamperproof Star Key T9 ~ 50
- 2 Flexible & Magnetic Bit
- 1 Socket Holder Adapter
- 3 Ratcheting Screwdriver Standard - Stubby - T Handle



Full Tray
 4200g 2 Sets / 10 Kgs / 1.76 CUFT

MS-044M 44pcs Metric Complete Wrench Set

- 10 Stubby Ratcheting Wrench
10 - 11 - 12 - 13 - 14 - 15 - 16 - 17 - 18 - 19mm
- 26 Combination Wrench
6 - 7 - 8 - 9 - 10 - 11 - 12 - 13 - 14 - 15 - 16 - 17 - 18 - 19 - 20 - 21 - 22 - 23 - 24 - 25 - 26 - 27 - 28 - 29 - 30 - 32mm
- 8 Extra Long Box End Wrench
8x10 - 10x12 - 12x14 - 13x15 - 14x17 - 16x18 - 17x19 - 22x24mm



Full Tray
 10.7 Kg 2 Sets / 23 Kgs / 1.76 CUFT

MS-035S 35pcs SAE Complete Wrench Set

- 7 Stubby Ratcheting Wrench
3/8 - 7/16 - 1/2 - 9/16 - 5/8 - 11/16 - 3/4"
- 8 Ratcheting Wrench
5/16 - 3/8 - 7/16 - 1/2 - 9/16 - 5/8 - 11/16 - 3/4"
- 16 Combination Wrench
1/4 - 5/16 - 3/8 - 7/16 - 1/2 - 9/16 - 5/8 - 11/16 - 3/4 - 13/16 - 7/8 - 15/16 - 1" - 1 1/16 - 1 1/8 - 1 1/4"
- 4 Extra Long Box End Wrench 5/16x3/8 - 7/16x1/2 - 9/16x5/8 - 11/16x3/4"



Full Tray
 7400g 2 Sets / 17 Kgs / 1.76 CUFT

MS-041MS 41pcs Metric & SAE Combination & Flare Nut Wrench

- 18 Metric Combination Wrench
6 - 7 - 8 - 9 - 10 - 11 - 12 - 13 - 14 - 15 - 16 - 17 - 18 - 19 - 21 - 22 - 23 - 24mm
- 12 SAE Combination Wrench
1/4 - 5/16 - 3/8 - 7/16 - 1/2 - 9/16 - 5/8 - 11/16 - 3/4 - 13/16 - 7/8 - 15/16"
- 6 Metric Flare Nut Wrench
9x11 - 10x12 - 13x14 - 15x17 - 16x18 - 19x21mm
- 5 SAE Flare Nut Wrench
1/4x5/16 - 3/8x7/16 - 1/2x9/16 - 5/8x11/16 - 3/4x7/8"



Full Tray
 6500g 2 Sets / 15 Kgs / 1.76 CUFT

Full Tray Sets

MS-023 23pcs Punch, Chisel & Hammer Set

- 9 Punch
Pin 2 - 3 - 4 - 5 - 6mm
Center 3 - 5mm
Line Up 3 - 5mm
- 5 Flat Chisel
6 - 10 - 12 - 14 - 16mm
- 2 Slotted Tang-Thru Screwdriver
10 - 12mm
- 2 Philips Tang-Thru Screwdriver
#2 - 3
- 4 Claw Hammer - Ball Peen Hammer - Drilling Hammer - Soft Face Hammer
- 1 Close Quarter Bar 460mmL (18"L)



Full Tray
 6700g 2 Sets / 15 Kgs / 1.76 CUFT

MS-015 15pcs Pliers Set

- 3 Locking Pliers
Curved Jaw 250mmL (10"L)
Long Nose 230mmL (9"L)
C-Clamp 150mmL (6"L)
- 5 Pliers
Side Cutter 180mmL (7"L)
Chain Nose 150mmL (6"L)
Diagonal Cutting 150mmL (6"L)
Water Pump 250mmL (10"L)
Combination Slip Joint
200mmL (8"L)
- 4 Retaining Ring Pliers Straight Nose Ext./Int. & 90° Bent Nose Ext./Int.
- 3 Adjustable Wrench 200mmL (8"L) - Heavy Duty Pipe Wrench 300mmL (12"L)
Straight Tip Aviation Snip 250mmL (10"L)



Full Tray
 5500g 2 Sets / 13 Kgs / 1.76 CUFT

MS-035MS 35pcs Pliers & Screwdriver Set

- 1 Curved Jaw Locking Plier w/ Cutter
180mmL (7"L)
- 4 Pliers
Side Cutter 180mmL (7"L)
Chain Nose 150mmL (6"L)
Diagonal Cutting 150mmL (6"L)
Water Pump 250mmL (10"L)
- 1 Adjustable Wrench 24mm Jaw
- 1 Ball Peen Hammer 3/4 lbs.
- 18 Wobble Hex Key
1.5 ~ 10mm & 1/16 ~ 3/8"
- 4 Slotted Screwdriver 3.0 ~ 6.5mm
- 4 Philips Screwdriver #0 ~ 2
- 2 Slotted & Philips Tang-Thru Screwdriver 6.5mm & #3



Full Tray
 4500g 2 Sets / 11.5 Kgs / 1.76 CUFT

MS-139MS* 139pcs 1/4", 3/8" & 1/2" Dr. Metric & SAE Tool Set

- 19 1/4" Dr. 12pt. Hand Socket
6 ~ 22mm & 3/16 ~ 1/2"
- 15 1/4" Dr. 12pt. Universal Hand Socket
6 ~ 14mm & 1/4 ~ 9/16"
- 16 1/4" Dr. Hex Head Socket
3 ~ 10mm & 1/8 ~ 3/8"
- 22 3/8" Dr. 12pt. Hand Socket
8 ~ 19mm & 5/16 ~ 3/4"
- 17 3/8" Dr. 12pt. Universal Hand Socket
10 ~ 19mm & 3/8 ~ 3/4"
- 31 1/2" Dr. 12pt. Hand Socket
10 ~ 32mm & 3/8 ~ 1 1/4"
- 6 Extension 1/4" Dr. 50 - 100mmL
3/8" Dr. 75 - 150mmL
1/2" Dr. 125 - 250mmL
- 3 1/4" - 3/8" - 1/2" Dr. Hinge Handle
- 3 1/4" - 3/8" - 1/2" Dr. Quick Release Ratchet
- 3 1/4" - 3/8" - 1/2" Dr. Universal Joint
- 1 1/4" Dr. Socket Driver
- 1 3/8" Dr. Adapter 1/4" M
- 2 3/8" Dr. Spark Plug
16mm (5/8") & 20.6mm (13/16")

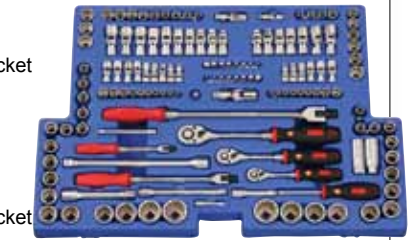

Full Tray
 10.5 Kg 3 Sets / 35.5 Kgs / 2.7 CUFT

*MS-139MS specially designed for fitting in top chests TS-244 or TS-790

Master Sets

Master Tool Sets

MS-110TS 110pcs 1/4", 3/8" & 1/2" Dr. Metric Mechanic Tool Set

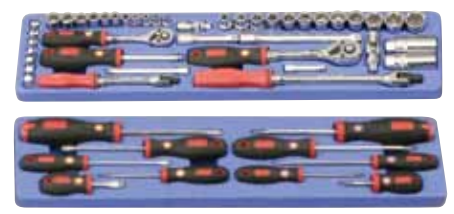

- 11 1/4"Dr. Hand Socket 3 ~ 13mm
- 8 1/4"Dr. Hex Head Socket 3 ~ 10mm
- 12 3/8"Dr. Hand Socket 8 ~ 19mm
- 17 1/2"Dr. Hand Socket 10 ~ 32mm
- 18 Combination Wrench 6 ~ 24mm
- 4 Slotted Screwdriver 3.0 ~ 6.5mm
- 4 Philips Screwdriver #0 ~ 2
- 1 Slotted Tang-Thru Screwdriver 6.5mm
- 1 Philips Tang-Thru Screwdriver #1
- 9 Wobble Hex Key 1.5 ~ 10mm
- 3 1/4", 3/8" & 1/2"Dr. Universal Joint
- 2 3/8"Dr. Spark Plug 16mm - 20.6mm
- 6 1/4", 3/8" & 1/2"Dr. Ext. 50 - 75 - 100 - 125 - 150 - 250mmL
- 1 1/4"Dr. Socket Driver
- 3 1/4", 3/8" & 1/2"Dr. Hinge Handle
- 3 1/4", 3/8" & 1/2"Dr. Quick Release Ratchet
- 1 8" Adjustable Wrench
- 1 12" Ball Peen Hammer



- 5 6" Chain Nose Pliers w/ Cutter
- 6" Diagonal Cutting Pliers
- 7" Side Cutter Pliers
- 10" Water Pump Pliers
- 7" Curved Jaw Locking Pliers w/ Cutter

1 **TS-125** 5 Tier Portable Tool Chest
 21 kgs 1 Set / 22 Kgs / 2 CUFT

MS-142TS 142pcs 1/4" & 1/2" Dr. Metric Mechanic Tool Set



- 14 1/4"Dr. Hand Socket 3 ~ 14mm
- 5 1/4"Dr. Deep Hand Socket 6 ~ 13mm
- 14 1/2"Dr. Hand Socket 8 ~ 24mm
- 17 Combination Wrench 6 ~ 24mm
- 4 Slotted Screwdriver 3.0 ~ 6.5mm
- 3 Philips Screwdriver #1 ~ 2
- 6 Slotted Bit 3.0 ~ 7.0mm
- 4 Philips Bit #0 ~ 3
- 8 Hex Bit #2 ~ 8mm
- 11 Star Bit T6 ~ 40
- 11 Tamperproof Star Bit T7 ~ 45
- 3 Triple Square Bit M4 ~ 6
- 1 Socket Holder Adapter
- 1 1/4" Hex Shank Bit Holder
- 2 1/4" & 1/2"Dr. Universal Joint
- 2 1/2"Dr. Spark Plug 16mm - 20.6mm
- 4 1/4" & 1/2"Dr. Extension Bar 50 - 75 - 100 - 250mmL
- 1 1/4"Dr. Flexible Spinner
- 1 1/4"Dr. Socket Driver
- 2 1/4" & 1/2"Dr. Reversible Ratchet
- 9 Wobble Hex Key 1.5 ~ 10mm
- 10 Tamperproof Star Key T9 ~ 50
- 3 Pin Punch 3 - 5mm & Flat Chisel 19mm
- 1 12" Ball Peen Hammer



- 5 6" Chain Nose Pliers w/ Cutter
- 6" Diagonal Cutting Pliers
- 7" Side Cutter Pliers
- 10" Water Pump Pliers
- 7" Curved Jaw Locking Pliers w/ Cutter

1 **TS-125** 5 Tier Portable Tool Chest
 17 kgs 1 Set / 18 Kgs / 2 CUFT

MS-190TS 190pcs 1/4", 3/8" & 1/2" Dr. Metric & SAE Mechanic Tool Set



- 20 1/4"Dr. Hand Socket 4 ~ 13mm & 3/16 ~ 1/2"
- 6 1/4"Dr. 12pt. Universal Socket 1/4 ~ 9/16"
- 16 1/4"Dr. Hex Head Socket 3 ~ 10mm & 1/8 ~ 3/8"
- 22 3/8"Dr. Hand Socket 8 ~ 19mm(6pt.) & 5/16 ~ 3/4"(12pt.)
- 7 3/8"Dr. 12pt. Universal Socket 3/8 ~ 3/4"
- 31 1/2"Dr. Hand Socket 10 ~ 32mm(6pt.) & 3/8 ~ 1 1/4"(12pt.)
- 30 Combination Wrench 6 ~ 24mm & 1/4 ~ 15/16"
- 5 Flare Nut Wrench 1/4x5/16 ~ 3/4x7/8"
- 8 Screwdriver Slotted 3.0 ~ 6.5mm & Philips #0 ~ 2
- 2 Tang-Thru Screwdriver Slotted 6.5mm & Philips #1
- 18 Wobble Hex Key 1.5 ~ 10mm & 1/16 ~ 3/8"
- 3 1/4", 3/8" & 1/2"Dr. Universal Joint
- 2 3/8"Dr. Spark Plug 16mm - 20.6mm
- 6 1/4", 3/8" & 1/2"Dr. Ext. 50 - 75 - 100 - 125 - 150 - 250mmL
- 1 1/4"Dr. Socket Driver
- 3 1/4", 3/8" & 1/2"Dr. Hinge Handle
- 3 1/4", 3/8" & 1/2"Dr. Quick Release Ratchet



- 5 6" Chain Nose Pliers w/ Cutter
- 6" Diagonal Cutting Pliers
- 7" Side Cutter Pliers
- 10" Water Pump Pliers
- 7" Curved Jaw Locking Pliers w/ Cutter
- 1 12" Ball Peen Hammer
- 1 8" Adjustable Wrench

1 **TS-125** 5 Tier Portable Tool Chest
 25.5 kgs 1 Set / 26.5 Kgs / 2 CUFT

Master Tool Sets

MS-236TS 236pcs 3/8" Dr. Metric Mechanic Tool Set

- 1 **MS-106M** 106pcs 3/8"Dr. Metric Tool Set
- 1 **MS-044M** 44pcs Metric Complete Wrench Set
- 1 **MS-086** 86pcs Screwdriver & Bit Set
- 1 **TS-465P** 5 Drawer Roller Cabinet w/ Inter Lock System

81 kgs 1 Set / 87 Kgs / 18 CUFT



MS-266TS 266pcs 1/4" & 1/2" Dr. Metric Mechanic Tool Set

- 1 **MS-098M** 98pcs 1/4" & 1/2"Dr. Metric Tool Set
- 1 **MS-044M** 44pcs Metric Complete Wrench Set
- 1 **MS-086** 86pcs Screwdriver & Bit Set
- 1 **MS-023** 23pcs Punch, Chisel & Hammer Set
- 1 **MS-015** 15pcs Pliers Set
- 1 **TS-467P** 7 Drawer Roller Cabinet w/ Inter Lock System

107 kgs 1 Set / 119 Kgs / 20 CUFT



Master Tool Sets

MS-361TS 361pcs 3/8" Dr. Metric & SAE Mechanic Tool Set

- 1 **MS-106M** 106pcs 3/8"Dr. Metric Tool Set
- 1 **MS-090S** 90pcs 3/8"Dr. SAE Tool Set
- 1 **MS-044M** 44pcs Metric Complete Wrench Set
- 1 **MS-035S** 35pcs SAE Complete Wrench Set
- 1 **MS-086** 86pcs Screwdriver & Bit Set
- 1 **TS-798** 7 Drawer Roller Cabinet

102 kgs 1 Set / 112 Kgs / 18.5 CUFT



MS-322TS 322pcs 1/4" & 1/2" Dr. Metric & SAE Mechanic Tool Set

- 1 **MS-098M** 98pcs 1/4" & 1/2"Dr. Metric Tool Set
- 1 **MS-100S** 100pcs 1/4" & 1/2"Dr. SAE Tool Set
- 1 **MS-086** 86pcs Screwdriver & Bit Set
- 1 **MS-023** 23pcs Punch, Chisel & Hammer Set
- 1 **MS-015** 15pcs Pliers Set
- 1 **TS-467P** 7 Drawer Roller Cabinet w/ Inter Lock System

107 kgs 1 Set / 114 Kgs / 20 CUFT



Master Sets

Master Tool Sets

MS-548TS 548pcs 1/4" & 1/2" Dr. Metric & SAE Master Tool Set

- 1 **MS-098M** 98pcs 1/4" & 1/2" Dr. Metric Tool Set
- 1 **MS-100S** 100pcs 1/4" & 1/2" Dr. SAE Tool Set
- 1 **MS-044M** 44pcs Metric Complete Wrench Set
- 1 **MS-035S** 35pcs SAE Complete Wrench Set
- 1 **MS-086** 86pcs Screwdriver & Bit Set
- 1 **MS-023** 23pcs Punch, Chisel & Hammer Set
- 1 **MS-015** 15pcs Pliers Set
- 1 **MS-057M** 57pcs 1/4" & 1/2" Dr. Swivel Socket & Bit Socket Set
- 1 **MS-035M** 35pcs Metric Flare Nut & L-Shaped Key Wrench Set
- 1 **MS-014** 14pcs Slotted, Philips & Posidriv Screwdriver Set
- 1 **MS-013** 13pcs Tang-Thru Screwdriver, Pry Bar & Carbon Scraper
- 1 **MS-028S** 28pcs SAE Flare Nut, E-Star & L-Shaped Key Wrench
- 1 **TS-790** 10 Drawer Top Tool Chest
- 1 **TS-797** 7 Drawer Side Cabinet
- 1 **TS-798** 7 Drawer Roller Cabinet

233 kgs 1 Set / 251 Kgs / 38 CUFT



Master Tool Sets

MS-926TS 926pcs 1/4" 3/8" & 1/2" Dr. Metric & SAE Master Tool Set

- 1 **MS-098M** 98pcs 1/4" & 1/2" Dr. Metric Tool Set
- 1 **MS-100S** 100pcs 1/4" & 1/2" Dr. SAE Tool Set
- 1 **MS-106M** 106pcs 3/8" Dr. Metric Tool Set
- 1 **MS-090S** 90pcs 3/8" Dr. SAE Tool Set
- 1 **MS-044M** 44pcs Metric Complete Wrench Set
- 1 **MS-035S** 35pcs SAE Complete Wrench Set
- 1 **MS-086** 86pcs Screwdriver & Bit Set
- 1 **MS-023** 23pcs Punch, Chisel & Hammer Set
- 1 **MS-015** 15pcs Pliers Set
- 1 **MS-057M** 57pcs 1/4" & 1/2" Dr. Swivel Socket & Bit Socket Set
- 1 **MS-027S** 27pcs 1/2" Dr. SAE Impact Socket & Accessory Set
- 1 **MS-042M** 42pcs 3/8" Dr. Metric Impact Socket & Star Socket Set
- 1 **MS-065S** 65pcs 3/8" Dr. Head Driver & Impact Socket Set
- 1 **MS-035M** 35pcs Metric Flare Nut & L-Shaped Key Wrench Set
- 1 **MS-028S** 28pcs SAE Flare Nut, E-Star & Key Wrench Set
- 1 **MS-014** 14pcs Slotted, Philips & Posidriv Screwdriver Set
- 1 **MS-013** 13pcs Tang-Thru Screwdriver, Pry Bar & Carbon Scraper Set
- 1 **MS-048MS** 48pcs Hex, Star, Triple Square & Square Bit Set
- 1 **TS-246** 6 Drawer Jumbo Top Chest
- 1 **TS-468** 7 Drawer Jumbo Roller Cabinet

263 kgs 1 Set / 278 Kgs / 43 CUFT



Master Tool Sets

MS-771 771pcs 1/4" 3/8" & 1/2" Dr. Metric & SAE Master Tool Set (without tool cabinet & tool chest)

Item No.	Piece	Description	Item No.	Piece	Description
TF-255MS	55	1/4" Dr. 6pt. Std./Deep Metric & SAE Impact Socket Set	TL-517X	17	Combination Screwdriver Set
700107	1	3/8" Dr. Impact Universal Joint	HS-5610M	10	Metric Hex Screwdriver Set
TG-308S	8	3/8" Dr. 6pt. Std. SAE Swivel Impact Socket Set	HS-5612S	12	SAE Hex Screwdriver Set
TG-312M	12	3/8" Dr. 6pt. Std. Metric Swivel Impact Socket Set	TX-513T	13	Star Screwdriver Set
700108	1	1/2" Dr. Impact Universal Joint	TL-504A	4	Square Screwdriver Set
IE-2349	9	1/4", 3/8" & 1/2" Dr. Impact Extension Set	ND-012M	12	Metric Hex Nut Driver Set
CM-326S	26	3/8" Dr. 6pt. Std./Deep SAE Impact Socket Set	ND-007S	7	SAE Hex Nut Driver Set
CM-332M	32	3/8" Dr. 6pt. Std./Deep Metric Impact Socket Set	780256	1	24mm Adjustable Wrench, 200 mmL
IS-422S	22	1/2" Dr. 6pt. Std. SAE Impact Socket Set	HS-024M	24	Metric Combination Wrench Set
DI-422S	22	1/2" Dr. 6pt. Deep SAE Impact Socket Set	HS-016S	16	SAE Combination Wrench Set
IS-425M	25	1/2" Dr. 6pt. Std. Metric Impact Socket Set	DE-713M	13	Metric Double Ended Offset Ring Wrench Set
DI-425M	25	1/2" Dr. 6pt. Deep Metric Impact Socket Set	DE-708S	8	SAE Double Ended Offset Ring Wrench Set
280226P	1	1/4" Dr. Hinge Handle	HK-009MB	9	Metric Wobble Hex Wrench Set
282262	1	1/4" Dr. 72 Teeth Flex Head Ratchet	HK-009SB	9	SAE Wobble Hex Wrench Set
GS-244MS	44	1/4" Dr. 6pt. Std./Deep Metric & SAE Hand Socket Set	SK-010T	10	L-Shaped Tamperproof Star Wrench Set
380336P	1	3/8" Dr. Hinge Handle	OS-505SP	5	Offset Slotted & Philips Screwdriver
380400	1	3/8" Dr. Speed Handle	782300	1	Heavy Duty Pipe Wrench, 300mmL
383363	1	3/8" Dr. 72 Teeth Flex Head Ratchet	CP-5804	4	General Purpose Plier Set
383338	1	3/8" Dr. 72 Teeth Flex Head Ratchet	RP-5504	4	Retaining Ring Plier Set
380371	1	1/4" & 3/8" Dr. Double Size Ratchet	530310RA	1	Straight Jaw Plier, 10"L
GS-347MS	47	3/8" Dr. 6pt. Std./Deep Metric & SAE Hand Socket Set	511003S	1	Straight Cut Aviation Snip, 250mmL
484464	1	1/2" Dr. 72 Teeth Flex Head Ratchet	590116	1	Claw Hammer 1 lbs./454g
480420	1	1/2" Dr. Speed Handle 420 mmL	590208	1	Ball Peen Hammer 1/2 lbs./227g
480446P	1	1/2" Dr. Hinge Handle	590216	1	Ball Peen Hammer 1 lbs./454g
480448P	1	1/2" Dr. Hinge Handle	590348	1	Drilling Hammer 3 lbs./1362g
TW-446MS	46	1/2" Dr. 12pt. Std. Metric & SAE Hand Socket Set	590416	1	Soft Face Hammer 1 lbs./454g
DS-422S	22	1/2" Dr. 6pt. Deep SAE Hand Socket Set	590524	1	Rubber Mallet 1-1/2 lbs./681g
DS-425M	25	1/2" Dr. 6pt. Deep Metric Hand Socket Set	PC-514S	14	SAE Punch & Chisel Set
TX-23414	14	1/4", 3/8" & 1/2" Dr. Star Hand Socket Set	CW-404MS	4	Metric & SAE Car Wheel Thin Wall Deep Impact Socket Set
TX-2353	53	1/4" & 3/8" Dr. Bit Socket Set	002034	1	Magnetic Parts Tray, Double
TX-246S	46	SAE Extra Long Screwdriver Bits With OMINDRIVE® Set	AT-B16	1	Telescoping Magnetic Pick-Up Tool
ID-414	14	1/2" Dr. Impact Driver Set	PB-5094	4	Pry Bar Set

139 kgs

1 Set / 147 Kgs / 8 CUFT

MS-771TS 771pcs 1/4" 3/8" & 1/2" Dr. Metric & SAE Master Tool Set (with tool cabinet & tool chest)

- 1 **MS-771** 771pcs 1/4" 3/8" & 1/2" Dr. Metric & SAE Master Tool Set
- 1 **TS-710** 6 Drawer Top Tool Chest
- 1 **TS-748** 8 Drawer Side Tool Cabinet
- 1 **TS-796** 8 Drawer Roller Cabinet

460 kgs

1 Set / 477 Kgs / 39.4 CUFT



Master Sets

Master Tool Sets

MS-215TS 215pcs 1/4", 3/8" & 1/2" Dr. Metric & SAE Tool Set

- 1 **MS-139MS** 139pcs
1/4", 3/8" & 1/2" Dr.
Metric & SAE Tool Set
- 1 **MS-041MS** 41pcs Metric & SAE
Combination &
Flare Nut Wrench Set
- 1 **MS-035MS** 35pcs Pliers &
Screwdriver Set
- 1 **TS-790** 10 Drawer Top Chest

73 kgs 1 Set / 82 Kgs / 11.2 CUFT



Master Tool Sets

MS-221TS 221pcs 1/4" & 1/2" Dr. Metric Mechanic Tool Set

- 1 **MS-013SP** 13pcs
Slotted & Phillips
Screwdriver Set
- 1 **MS-121M** 121pcs 1/4" Dr.
Metric Hand Socket
& Bit Set
- 1 **MS-437M** 37pcs 1/2" Dr. Metric
Hand Socket Set
- 1 **MS-024M** 24pcs Metric
Combination &
Box End Wrench Set
- 1 **MS-019** 19pcs Punch, Chisel
& Hammer Set
- 1 **MS-007P** 7pcs Pliers Set
- 1 **TS-244** 4 Drawer Top Chest

49 kgs 1 Set / 52 Kgs / 7.3 CUFT



MS-215TA 215pcs 1/4", 3/8" & 1/2" Dr. Metric & SAE Tool Set

- 1 **MS-139MS** 139pcs
1/4", 3/8" & 1/2" Dr.
Metric & SAE Tool Set
- 1 **MS-041MS** 41pcs Metric & SAE
Combination &
Flare Nut Wrench Set
- 1 **MS-035MS** 35pcs Pliers &
Screwdriver Set
- 1 **TS-244** 4 Drawer Top Chest

53 kgs 1 Set / 59 Kgs / 8.6 CUFT



Master Tool Sets

MS-243TS 243pcs 1/4" & 1/2" Dr. Metric Mechanic Tool Set

- 1 **MS-013SP** 13pcs Slotted & Philips Screwdriver Set
- 1 **MS-121M** 121pcs 1/4" Dr. Metric Hand Socket & Bit Set
- 1 **MS-437M** 37pcs 1/2" Dr. Metric Hand Socket Set
- 1 **MS-024M** 24pcs Metric Combination & Box End Wrench Set
- 1 **MS-019** 19pcs Punch, Chisel & Hammer Set
- 1 **MS-007P** 7pcs Pliers Set
- 1 **MS-008R** 8pcs Retaining Ring Pliers & Oil Filter Wrench Set
- 1 **MS-014A** 14pcs Combination Auto Repair Tool Kit
- 1 **TS-467P** 7 Drawer Roller Cabinet w/ Inter Lock

91 kgs 1 Set / 100 Kgs / 17.9 CUFT



Master Tool Sets

MS-363TS 363pcs 1/4", 3/8" & 1/2" Dr. Metric Mechanic Tool Set

- 1 **MS-013SP** 13pcs Slotted & Philips Screwdriver Set
- 1 **MS-013T** 13pcs Star Screwdriver Set
- 1 **MS-121M** 121pcs 1/4" Dr. Metric Hand Socket & Bit Set
- 1 **MS-071M** 71pcs 3/8" Dr. Metric Hand Socket & Bit Socket Set
- 1 **MS-437M** 37pcs 1/2" Dr. Metric Hand Socket Set
- 1 **MS-442B** 42pcs 1/2" Dr. Bit Socket Set
- 1 **MS-020M** 20pcs Metric Combination Wrench
- 1 **MS-020B** 20pcs Metric Box End, Open End & E-Star Wrench Set
- 1 **MS-019** 19pcs Punch, Chisel & Hammer Set
- 1 **MS-007P** 7pcs Pliers Set
- 1 **TS-467P** 7 Drawer Roller Cabinet w/ Inter Lock

102 kgs 1 Set / 111 Kgs / 17.9 CUFT

